



Network Statement on Nationwide and Regional Railways

**Valid for the Preparation of the Timetable 2024 and
the Timetable 2024 in force as of 9. 12. 2022**

Ref. No. 81352/2022-SŽ-GŘ-05

Contents¹

List of abbreviations	9
1 General information	11
1.1 Introduction	11
1.2 Purpose of the Network Statement	11
1.3 Legal Aspects	11
1.3.1 Legal Framework	11
1.3.2 Legal Status and Liability	11
1.3.3 Appeals Procedure	11
1.4 Structure of the Network Statement	12
1.5 Validity Period, Updating and Publishing	13
1.5.1 Validity Period	13
1.5.2 Updating	13
1.5.3 Publishing	13
1.6 Contacts	13
1.7 Cooperation Between European IMs/ABs	16
1.7.1 Rail Freight Corridors	16
1.7.2 RailNetEurope and other international organizations	16
2 Infrastructure	16
2.1 Introduction	16
2.2 Extent of Network	17
2.2.1 Limits	17
2.2.2 Connecting Railway Networks	17
2.3 Network Description	18
2.3.1 Track Typologies	18
2.3.2 Track Gauges	18
2.3.3 Stations and Nodes	18
2.3.4 Loading Gauge	18
2.3.5 Weight Limits	19
2.3.6 Line Gradients	20
2.3.7 Maximum Line Speed	20
2.3.8 Maximum Train Lengths	20
2.3.9 Power Supply	20
2.3.10 Signalling Systems	21
2.3.11 Traffic Control Systems	21
2.3.12 Communication System	22
2.3.13 Train Control Systems	22

¹ The data contained in Annexes and maps reflect a condition known at the date of Statement. Current data on the state and regional railway lines operated by Správa železnic publishes on webpage (<https://provoz.spravazeleznic.cz>) and on information system DYPOD (<https://provoz.spravazeleznic.cz/dypod>).

2.3.14	Automatic Train Operation	22
2.4	Traffic Restrictions	23
2.4.1	Specialized Infrastructure	24
2.4.2	Environmental Restrictions.....	24
2.4.3	Dangerous Goods	25
2.4.4	Tunnel Restrictions	25
2.4.5	Bridge Restrictions	26
2.5	Availability of the Infrastructure.....	26
2.5.1	Restriction of Railway Operation	26
2.5.2	Personnel Limitation of Infrastructure Availability.....	27
2.6	Infrastructure Development	27
2.6.1	Main projects of infrastructure development.....	27
2.6.2	ETCS Development	27
2.6.3	Construction of long tunnels.....	27
3	Access conditions.....	28
3.1	Introduction	28
3.2	General Access Requirements.....	28
3.2.1	Conditions for Applying for Capacity	28
3.2.2	Conditions for Access to the Railway Infrastructure	29
3.2.3	Licences	29
3.2.4	Safety Certificate	30
3.2.5	Insurance	30
3.3	Contractual Arrangements.....	30
3.3.1	Framework Agreement	30
3.3.2	Contracts with RUs.....	31
3.3.3	Contracts with non-RU Applicants	33
3.3.4	General Terms and Conditions	33
3.4	Specific Access Requirements	33
3.4.1	Rolling Stock Acceptance	33
3.4.2	Staff Acceptance.....	35
3.4.3	Exceptional Consignments	35
3.4.4	Dangerous Goods	37
3.4.5	Test Trains and Other Special Trains	38
3.4.6	Rides from local or siding to national or regional railways	38
4	Capacity allocation.....	39
4.1	Introduction	39
4.2	General Description of the Process	39
4.2.1	Capacity request.....	39
4.2.2	Mandatory data in the capacity request	41
4.2.3	Capacity allocation	42
4.3	Reserving Capacity for Temporary Capacity Restrictions	43
4.3.1	General Principles	43

4.3.2	Deadlines and Information Provided to Applicants	43
4.4	Impacts of Framework Agreements	45
4.5	Path Allocation Process	45
4.5.1	Annual Timetable Path Requests	45
4.5.2	Late Annual Timetable Path Requests	48
4.5.3	Ad-Hoc Path Requests	49
4.5.4	Coordination Process	52
4.5.5	Dispute Resolution Process.....	53
4.6	Congested Infrastructure	53
4.7	Exceptional Transport and Dangerous Goods	53
4.7.1	Exceptional Transport.....	53
4.7.2	Dangerous Goods	54
4.8	Rules After Path Allocation	54
4.8.1	Rules for Path Modification	54
4.8.2	Rules for Path Alteration	55
4.8.3	Non-Usage Rules	56
4.8.4	Rules for Cancellation	56
4.8.5	Rules for capacity withdrawal	57
4.9	Timetabling and Capacity Redesign (TTR)	57
4.9.1	Objectives of TTR.....	57
4.9.2	Process Components	57
4.9.3	Implementation	58
4.9.4	TTR Pilot Project	60
4.10	Principles of capacity allocation on railway freight corridors	60
5	Services and charges	60
5.1	Introduction	60
5.2	Charging Principles.....	60
5.3	Minimum Access Package and Charges	61
5.4	Additional Services and Charges	63
5.4.1	Supply of traction electricity	63
5.4.2	Preheating of a railway vehicle intended for the transport of persons	63
5.4.3	Services related to the transport of dangerous goods or to the operation of a railway vehicle having special operational and technical characteristics.....	63
5.5	Ancillary Services and Charges	65
5.5.1	Provision of information related to the operation of rail transport	65
5.5.2	Access to telecommunication networks	65
5.5.3	Providing Audio-visual Information to Passengers	66
5.5.4	Issue of the Timetable	66
5.6	Financial Penalties and Incentives	66
5.6.1	Penalties for Path Modification	66
5.6.2	Penalties for Path Alteration	67

5.6.3	Penalties for Non-usage	67
5.6.4	Penalties for Path Cancellation	67
5.6.5	Incentives / Discounts	67
5.7	Performance Scheme	67
5.7.1	General principles and objectives	67
5.7.2	Performance monitoring	68
5.7.3	Financial model	69
5.7.4	Governance and dispute resolution system.....	71
5.8	Changes to Charges	73
5.9	Billing Arrangements	73
5.9.1	Billing Arrangements on the line operated by PKP CARGO INTERNATIONAL a.s.	73
5.9.2	Billing Arrangements on the lines operated by PDV RAILWAY a.s.	73
5.9.3	Billing Arrangements on the lines operated by Správou železnic	74
6	Operations.....	75
6.1	Introduction	75
6.2	Operational Rules.....	75
6.3	Operational Measures	76
6.3.1	Principles	76
6.3.2	Operation Regulation.....	76
6.3.3	Disturbances	76
6.4	Tools for Train Information and Monitoring	77
7	Service facilities	78
7.1	Introduction	78
7.2	Service Facility Overview	78
7.3	Service Facilities Managed by the Správa železnic	79
	Annex "A" Rejstřík použitých pojmů.....	80
	Annex "B"	83
	Annex "C" Prices for the Use of infrastructure, financial penalties and incentives related to the use of allocated capacity	145
	Annex "D" Form for holders not being in possession of a valid licence:	156
	Annex "E" FORM FOR NATIONAL PATH STUDIES AND REQUESTS	157
	Annex "F" Train Radio Devices	163
	Annex "G" ETCS.....	170
	Annex "H" List of connected lines	186
	Annex "I" Profile of the clearance Z-GB, Z-GC, Z-G2 and Z-GCZ3 and free walkable and manipulation space	227
	Annex "J" Devices for diagnosing defects of rolling stock vehicles.....	231
	Annex "K" Draft sample arrangement on penalty payments for disruption of rail transport and non-using allocated railway infrastructure capacity	234
	Annex "L" Common Template for Service Facilities	238
	Annex "M" Use of codes in justifying train delays on railways operated by Správa železnic and dispute resolution procedures	246

Annex "N" Conditions for granting permission to occupy tracks	252
Annex "O" Internal regulations of the railway operator Správa železnic binding for RU and non-RU applicants	259
Annex "P" Uniform terms and conditions of the Správa železnic	262
Annex "R" Procedures for capacity allocation on Rail Freight Corridor	276
Map M01 Numbering of lines according to Official Permit	294
Map M02 Category of railways and rail system operators.....	295
Map M03 Rail freight corridors	296
Mapa M04 Numbering of lines according to TTP.....	297
Map M05 Number of tracks, electrification systems and numbers according to timetable	298
Map M06 Remote control of operation	299
Map M07 Allowed line classes of loading (axle load / load per meter)	300
Map M08 Railway signalling systems.....	301
Map M09 Cab signalling (ATP).....	302
Map M10 Primary ground-to-train radio communication	303
Map M11 Lines codes for combined traffic.....	304
Map M12 Oblastní ředitelství Správa železnic (OŘ), Stavební správy a Provozní obvody	305
Map M13 Information points of system AVV (ATO).....	306
Map M14 Lines where non usage charges and cancellation fees are applied	307

List of abbreviations

AC	alternating current
ATO	automatic train operation
ATP	automatic train protection
AVV	automatic train protectionh (<i>automatické vedení vlaku</i>)
CEN	Comité Européen de Normalisation
CER	Community of European Railways and Infrastructure Companies
CID	Corridor Information Document
C-OSS	Corridor OneStopShop
DC	direct current
DOK	Capacity restriction
ERFA	European Rail Freight Association
ERNCF	European Rail Network for Competitive Freight
ERTMS	European Rail Traffic Management System
ETCS	European Train Control System
EU	European Union
FTE	Forum Train Europe
GPS	Global Position System
GSM-R	Global System for Mobile Communication – Railway
IS	information system
IT	Information technologie
MF	Ministri of Finance (<i>Ministerstvo financí</i>)
MRS	local radio network in the 150 MHz band
MZ	Exceptional Consignments
OSS	OneStoShop
PLM	out-of-gauge loads
Railway Operation Portal	internet portal of Správa železnic https://provoz.spravazeleznic.cz
RBC	Radio Block Center
RFC	Rail Freight Corridor
RICS	Railway Interchange Coding System
RID	Règlement concernant le transport international ferroviaire des marchandises dangereuses
RNE	RailNetEurope
RU	Railway Undertaker
Správa železnic	Správa železnic, státní organizace
SRD	radio dispatch network in the 450 MHz band
SRV	train radio dispatch network in the 150 MHz band
SW	Software
TCR	Temporary Capacity Restriction
TSI CCS	Technical Specifications for Interoperability Control Command and Signalling
TSI SRT	Regulation (EU) No. 1303/2014 of Safety in Railway Tunnels
TSI TAF	Technical Specification for Interoperability relating to the Telematics Applications for Freight subsystem of the rail system in the European Union

TSI TAP	Technical Specification for Interoperability relating to the Telematics Applications for Passanger subsystem of the rail system in the European Union
TTP	Route Book (<i>tabulky traťových poměrů</i>)
TTR	Timetabling and Capacity Redesign
UIC	Union Internationale des Chemins de fer
ÚPDI	Transport Infrastructure Access Authority (<i>Úřad pro přístup k dopravní infrastruktuře</i>)
URMIZA	Central list of Exceptional Consignments (<i>ústřední registr mimořádných zásilek</i>)
ŽDC	Railway infrastructure (<i>železniční dopravní cesta</i>)

1 General information

1.1 Introduction

Správa železnic, státní organizace (hereafter „Správa železnic“), is a state organization under public law. Správa železnic wishes to contribute to sustainable mobility within the European rail network in order to boost economic and social development in the Czech Republic.

It is responsible for the operation, maintenance and renewal of railway infrastructure, for the control and the safety of all train traffic as well as for participating in the development of the infrastructure.

Article 27 of Directive 2012/34/EU and The Rail Act No. 266/1994 Coll. (hereafter „Rail Act“) gives the IM the task of drafting and publishing the Network Statement (NS).

1.2 Purpose of the Network Statement

The purpose of the Network Statement is to inform applicants, authorities and other interested parties about Správa železnic's infrastructure, conditions of access to it and the terms and conditions for allocation and use of capacity and services, as well as the related charges.

The Network Statement is produced in accordance with Article 27 and Annex IV of Directive 2012/34/EU and § 33 of Rail Act.

1.3 Legal Aspects

1.3.1 Legal Framework

In Czech Republic, basic legal conditions for the construction of railways, the conditions for the operation of railways, the operation of railway transport on these railways, as well as rights and obligations of natural and legal persons associated with them are stipulated by the Rail Act and its implementing regulations, as amended, as well as directly effective regulations of the European Union.

Selected regulations are published on the website of the Ministry of Transport <http://www.mdcr.cz/Dokumenty/Drazni-doprava/Legislativa-v-drazni-doprave>.

1.3.2 Legal Status and Liability

When concluding a contract for the operation of rail transport between Správa železnic, as a capacity allocator and railway operator, and the applicant, the conditions stated in this Network Statement are binding on both Contracting Parties.

Správa železnic continuously monitors if the text and data published in the Network Statement are correct, with the exception of the data provided or authorised by external suppliers.

Správa železnic is not responsible for the data and texts provided to the railway operator or service management.

1.3.3 Appeals Procedure

The Rail Act imposes the processor the Network Statement under the obligation of allowing interested persons to comment on its content at least 30 days before the date of its publication. Správa železnic publishes the draft of the Network Statement on the Infrastructure Operation Portal. Správa železnic shall publish the Network Statement no later than 12 months before the day when the annual timetable comes into force in a way allowing remote access. If any of the data contained in this Statement are changed, Správa železnic shall record the change and re-publish the Network Statement in a way allowing remote access and indicate the changes made therein.

The Transport Infrastructure Access Authority shall, on the proposal of the applicant for the allocation of the capacity of the railway or ex-officio, decide whether any of the parts of the published Network Statement are not in contradiction with the Rail Act. If the Network Statement was published due to data changes contained therein, the proposal can only be submitted for these changes. The applicant's proposal for capacity allocation must include details about the specific part of the Network Statement that is contrary to the Rail Act, about the nature of the conflict, and the identification of evidence needed to prove it. If the Transport Infrastructure Access Authority decides that any part of the Network Statement is in conflict with the Rail Act, it shall set a reasonable time limit in the decision after which no such part can be used. The capacity allocator shall replace the part, which is in conflict with the Rail Act, with a new part, which will be incorporated in the re-published Network Statement. The Transport Infrastructure Access Authority is obliged to issue a decision no later than 40 days from the date of commencement of the proceedings.

Upon the request of the applicant for the allocation of railway capacity or ex officio, the Transport Infrastructure Access Authority shall decide whether the scope of the allocated capacity or the procedure for its allocation is not in conflict with the Railway Act. The request must contain information on what is the discrepancy between the extent of the allocated railway capacity or the procedure for its allocation with the Railways Act, and an indication of the evidence needed to prove it. If the Transport Infrastructure Access Authority decides that the scope of the allocated railway capacity is in conflict with this Act, it shall instruct the allocator to reallocate the railway capacity and determine the method of this allocation. Transport Infrastructure Access Authority is obliged to issue a decision no later than 40 days from the date of commencement of the proceedings.

Upon the proposal of one of the contracting parties to the contract on the operation of rail transport or ex officio, the Transport Infrastructure Access Authority shall decide whether such a contract is not in conflict with this Act. The proposal must contain information on which part of the contract is in conflict with the Railways Act, in what this conflict is seen and an indication of the evidence needed to prove it. If the Transport Infrastructure Access Authority decides that any of the parts of the contract is in conflict with the Railways Act, it shall set a reasonable period in the decision, after which such part may not be used. Transport Infrastructure Access Authority is obliged to issue a decision no later than 40 days from the date of commencement of the proceedings. Similarly, the Transport Infrastructure Access Authority, on the proposal of one of the parties participating in the negotiations on the conclusion of the contract on the operation of rail transport, or ex officio, assesses whether the proposal for the conclusion of the contract is not in conflict with the Railways Act.

1.4 Structure of the Network Statement

The structure of this NS follows the Network Statement Common Structure and Implementation Guide, adopted by European Infrastructure Managers belonging to RailNetEurope (RNE) (see 1.7.2), on the basis of the applicable European legal framework. The document is revised when needed and the most recent version is available on the RNE website (<http://www.rne.eu/organisation/network-statements/>). The goal of the Common Structure and Implementation Guide is that all applicants and interested parties can find the same information at the same place in each NS.

The NS is thus structured in 7 sections constituting the main body of the document and Annexes giving further details:

- Section 1 provides **general information** about the NS and contacts.
- Section 2 describes the main **technical and functional characteristics** of the IM's network.
- Section 3 defines the legal requirements and **access conditions** to the IM's network.
- Section 4 sets the procedure for the **allocation** of the train paths.
- Section 5 gives an overview of the **services** provided by Správa železnic, as well as the **charges** for these services. The incentive schemes are also described in this section.

- Section 6 describes the **traffic management procedures**, including the procedures to be followed in the event of incidents.
- Section 7 provides an overview of the **service facilities** connected to the IM's network.

1.5 Validity Period, Updating and Publishing

1.5.1 Validity Period

The NS applies to capacity requests and execution of planned transport operations (traffic movements) during the 2023 timetable starting on Sunday 11. December. 2022 at 0:00 and ending on Saturday 9. December 2023 at 24:00. The Network statement is effective from 11 December 2021. During the timetable, the Správa železnic plans one change, which will take effect on Sunday 11 June 2023 at 0:00.

1.5.2 Updating

Správa železnic regularly updates the Network Statement and edits it if necessary. The current version is published on the capacity allocator's website (www.spravazeleznic.cz).

In line with the further development of the common structure of the Network Statement within RNE, this Statement will be modified for the period of validity of the upcoming annual timetable.

1.5.3 Publishing

The Network Statement is drawn in Czech and published in Czech and English on the Správy železnic's website (www.spravazeleznic.cz) where it is available free of charge in electronic format. In the event of a conflict between the language versions, the Czech version of the Network Statement will be used primarily.

1.6 Contacts

Allocation Body and railway operators

One Stop Shop	Správa železnic, Odbor jízdního řádu	Tel.: +420 972 244 556 e-mail: oss@spravazeleznic.cz
Rail Freight Corridor	Správa železnic, Odbor mezinárodních vztahů	Tel.: +420 972 235 856 e-mail: kralm@spravazeleznic.cz
Contracts		
Framework agreement	Správa železnic, Odbor obchodních a smluvních vztahů	Tel.: +420 972 244 267 e-mail: slachta@spravazeleznic.cz
Use of infrastructure agreement	Správa železnic, Odbor obchodních a smluvních vztahů	Tel.: +420 972 244 267 e-mail: slachta@spravazeleznic.cz
	PKP Cargo international	Tel: +420596166256 e-mail: vladimir.kudla@pkpcargointernational.com
	PDV RAILWAY a.s.	e-mail: miroslav.vaculik@pdvr.cz
Non-RU applicant agreement	Správa železnic, Odbor obchodních a smluvních vztahů	Tel.: +420 972 244 267 e-mail: slachta@spravazeleznic.cz
Power supply	Správa železnic, státní organizace Centrum sdílených služeb	e-mail: epodatelnaenergie@spravazeleznic.cz
Data interchange for IT systems		
Správa železnic	Generální ředitelství, Odbor řízení provozu	e-mail: O11sek@spravazeleznic.cz
PKP Cargo international	Ředitel PO vlečky a Vedoucí regionální dráhy Vrbno pod Pradědem	e-mail: robert.marjanko@pkpcargointernational.com
PDV Railway	PDV RAILWAY a.s.	e-mail: miroslav.vaculik@pdvr.cz , dispecer@pdvr.cz

Capacity requests		
Annual timetable	Správa železnic, Odbor jízdního řádu	Tel.: +420 972 244 991 e-mail: kubena@spravazeleznic.cz
	PKP CARGO INTERNATIONAL, a.s.	Tel.: +420 596 166 650 e-mail: robert.marjanko@pkpcargointernational.com
	PDV Railway, a.s.	e-mail: miroslav.vaculik@pdvr.cz, dispecer@pdvr.cz
Ad hoc requests	Správa železnic, Odbor jízdního řádu	Tel.: +420 972 244 556, +420 972 244 606 e-mail: oss@spravazeleznic.cz
	PKP CARGO INTERNATIONAL, a.s.	Tel.: +420 596 166 650 e-mail: robert.marjanko@pkpcargointernational.com
	PDV RAILWAY a.s.	e-mail: miroslav.vaculik@pdvr.cz, dispecer@pdvr.cz
Test Trains and Other Special Trains	Správa železnic, Odbor jízdního řádu	Tel.: +420 972 244 573 e-mail: oss@spravazeleznic.cz
	PKP CARGO INTERNATIONAL, a.s.	Tel.: +420 596 166 650 e-mail: robert.marjanko@pkpcargointernational.com
	PDV RAILWAY a.s.	e-mail: miroslav.vaculik@pdvr.cz
National TTR manager	Správa železnic, Odbor jízdního řádu	Tel.: +420 972 244 261 e-mail: tehnikr@spravazeleznic.cz
Temporary capacity restrictions		
Planing of temporary capacity restriction	Správa železnic, Odbor plánování a koordinace výluk	Tel.: +420 972 244 254 e-mail: O12sek@spravazeleznic.cz
	Ředitel PO vlečky a Vedoucí regionální dráhy Vrbno pod Pradědem	Tel.: +420 596 166 650 e-mail: robert.marjanko@pkpcargointernational.com
	PDV RAILWAY a.s.	e-mail: miroslav.vaculik@pdvr.cz
Lockout timetable	Správa železnic, Odbor plánování a koordinace výluk	Tel.: +420 972 244 254 e-mail: O12sek@spravazeleznic.cz
Rail vehicles		
Exceptional transit of rail vehicles	Správa železnic, Odbor traťového hospodářství	Tel.: +420 972 524 523 e-mail: sanak@spravazeleznic.cz
ETCS	Správa železnic, Odbor zabezpečovací a telekomunikační techniky	Tel.: +420 602 318 976 e-mail: dobiasr@spravazeleznic.cz
Allocating encryption keys ETCS L2	Správa železnic, Centrum telematiky a diagnostiky	e-mail: CTDetcs@spravazeleznic.cz
Negotiating of extraordinary transport	Správa železnic, Odbor řízení provozu	Tel.: +420 972 244 761 e-mail: urmiza@spravazeleznic.cz
	Ředitel PO vlečky a vedoucí regionální dráhy Vrbno pod Pradědem	Tel.: +420 596 166 650 e-mail: robert.marjanko@pkpcargointernational.com
	PDV RAILWAY a.s.	e-mail: miroslav.vaculik@pdvr.cz, dispecer@pdvr.cz
Trafic management		
Správa železnic	Generální ředitelství, Odbor řízení provozu	Tel.: +420 972 244 178 e-mail: O11sek@spravazeleznic.cz
	CDP Praha	e-mail: ePodatelnaCDPPHA@spravazeleznic.cz
	CDP Přešov	e-mail: ePodatelnaCDPPRE@spravazeleznic.cz
PKP Cargo international	PKP CARGO INTERNATIONAL, a.s.	Tel.: +420 596 166 650 e-mail: robert.marjanko@pkpcargointernational.com
PDV Railway	PDV RAILWAY a.s.	e-mail: dispecer@pdvr.cz
Performance Scheme		
Správa železnic	Generální ředitelství, Odbor obchodních a smluvních vztahů	Tel.: +420 972 235 668 e-mail: O5sek@spravazeleznic.cz
PKP Cargo international	Ředitel PO vlečky a Vedoucí regionální dráhy Vrbno pod Pradědem	Tel.: +420 596 166 650 e-mail: robert.marjanko@pkpcargointernational.com
PDV Railway	PDV RAILWAY a.s.	e-mail: miroslav.vaculik@pdvr.cz

Invoicing		
Správa železnic	Generální ředitelství, Odbor obchodních a smluvních vztahů	Tel.: +420 972 235 668 e-mail: O5sek@spravazeleznic.cz
PKP Cargo international	Správa provozu, ekonomické oddělení	Tel.: +420596166251 e-mail: sarka.polednikova@pkpcargointernational.com
PDV Railway	PDV RAILWAY a.s.	Tel.: +420 352 609 180 e-mail: vlasta.buresova@pdvr.cz
Service facilities		
Správa železnic	Generální ředitelství, Odbor obchodních a smluvních vztahů	Tel.: +420 972 235 668 e-mail: O5sek@spravazeleznic.cz
PKP Cargo international	PO 01, správa	Tel.: +420 596 166 650 e-mail: robert.marjanko@pkpcargointernational.com
PDV Railway	PDV RAILWAY a.s.	e-mail: dispecer@pdvr.cz

Important state administration bodies

Ministerstvo dopravy (Ministry of Transport)	
Adress:	nábřeží Ludvíka Svobody 1222/12, 110 15 Praha 1
Telephone:	+420 225 131 111
E-mail:	posta@mdcr.cz
Data box:	n75aa03
Web:	www.mdcr.cz
Drážní úřad (Rail Authority)	
Adress:	Wilsonova 300/8, 121 06 Praha 2 - Vinohrady
Telephone:	+420 972 241 839
E-mail:	podatelna@ducr.cz
Data box:	5mjaa0d
Web:	www.ducr.cz
Drážní inspekce (Rail Safety Inspection Office)	
Adress:	Těšnov 1163/5, 110 00 Praha 1
Telephone:	+420 736 521 003
E-mail:	mail@dicr.cz
Data box:	vi6aigp
Web:	www.dicr.cz
Úřad pro přístup k dopravní infrastruktuře (Transport Infrastructure Access Authority)	
Adress:	Myslíkova 171/31, 110 00 Praha 1
Telephone:	+420 225 131 111
E-mail:	podatelna@updi.cz
Data box:	yhygbyn
Web:	www.updi.cz

International cooperation

RailNetEurope	
Web	http://rne.eu/
List of European OSS	
Web	http://rne.eu/organisation/oss-c-oss/
European Network statements	
Webové stránky RNE	http://rne.eu/organisation/network-statements/
European Agency for Railways (ERA)	
Webové stránky ERA	https://www.era.europa.eu/
Neighboring IM	
DB Netz	https://www.dbnetze.com/infrastruktur-de
Deutsche Regionaleisenbahn	https://regionaleisenbahn.de/
ÖBB Infra	https://infrastruktur.oebb.at/

PKP-PLK	https://www.plk-sa.pl/
ŽSR	https://www.zsr.sk/

1.7 Cooperation Between European IMs/ABs

1.7.1 Rail Freight Corridors

Regulation (EU) No. 913/2010 concerning a European rail network for competitive freight required Member States to establish international market-oriented Rail Freight Corridors (RFCs) in order to meet the following goals:

- - strengthening co-operation between IMs/ABs on key aspects such as the allocation of paths, deployment of interoperable systems and infrastructure development,
- - finding the right balance between freight and passenger traffic along the RFCs, giving adequate capacity for freight in line with market needs and ensuring that common punctuality targets for freight trains are met,
- - promoting intermodality between rail and other transport modes by integrating terminals into the corridor management process.

Správa železnic is involved in RFC Baltic-Adriatic, RFC Orient/East-Med, RFC North Sea-Baltic and RFC Rhine-Danube.

Link to RFC Baltic-Adriatic, RFC Orient/East-Med, RFC North Sea-Baltic and RFC Rhine-Danube website:

- RFC Baltic-Adriatic – <https://www.rfc5.it/>,
- RFC Orient/East-Med – www.rfc7.eu,
- RFC North Sea-Baltic – www.rfc8.eu,
- RFC Rhine-Danube – <http://rfc-rhine-danube.eu/>.

1.7.2 RailNetEurope and other international organizations

Správa železnic is a member of RailNetEurope (RNE), which is an umbrella organisation of European railway Infrastructure Managers and Allocation Bodies (IMs/ABs). RNE facilitates international railway business by developing harmonised international business processes in the form of templates, handbooks, and guidelines, as well as IT tools.

You can find more information about RNE on <http://www.rne.eu/organisation/rne-approach-structure/>

The Správa železnic is a member of the International Union of Railways (UIC), the Community of European Railways and Infrastructure Companies (CER) and other major railway associations.

The Správa železnic also works closely with DB Netz AG, Deutsche Regionaleisenbahn GmbH, ÖBB Infra AG, PKP-PLK SA and ŽSR, which operate related infrastructures in neighboring countries.

2 Infrastructure

2.1 Introduction

This chapter contains a description of the functional and technical characteristics of the railway infrastructure owned by the Czech Republic. It is formulated for the purpose of meeting existing and new Railway Undertakings' information needs in connection with their planning of railway traffic. Reference is made to (e.g. IMs document, Technical Rules, "Supplementary Information and regulations", maps).

2.2 Extent of Network

2.2.1 Limits

This Network Statements describes the railways where the Správa železnic is the allocation body, i.e. the national railway and regional railways owned by the state, the national and regional railways, which are not owned by the state, but where the Správa železnic is the railway operator and part of the regional railway owned by the state between the state border of the Czech Republic and the Kraslice railway station where the Správa železnic is authorized by PDV Railways, s.r.o. The list of individual lines and tracks where the Správa železnic is the allocation body is given in Annex "B".

2.2.2 Connecting Railway Networks

The contact points of nationwide and regional railways with railways in neighbouring countries:

The contact points of nationwide and regional railways with railways in neighbouring countries:

Border point	Connected IM
Aš st.hr. (km 29,585)	DB Netz AG (DB Netz)
Bohumín st.hr. (km 279,628)	PKP Polskie Linie Kolejowe S.A. (PKP-PLK)
Bohumín-Vrbice st.hr. (km 4,275)	PKP Polskie Linie Kolejowe S.A. (PKP-PLK)
Břeclav st.hr. (km 77,992)	ÖBB Infrastruktur AG (ÖBB Infra)
Česká Kubice st.hr. (km 184,102)	DB Netz AG (DB Netz)
České Velenice st.hr. (km 163,100)	ÖBB Infrastruktur AG (ÖBB Infra)
Český Těšín st.hr. (km 139,112)	PKP Polskie Linie Kolejowe S.A. (PKP-PLK)
Děčín st.hr. (km 11,860)	DB Netz AG (DB Netz)
Dolní Poustevna st.hr. (km 26,271)	DB Netz AG (DB Netz)
Frýdlant v Čechách st.hr. (km 200,107)	PKP Polskie Linie Kolejowe S.A. (PKP-PLK)
Harrachov st.hr. (km 40,111)	Dolnośląska Służba Dróg i kolei (DSDiK)
Hodonín st.hr. (km 3,009)	Železnice Slovenské republiky (ŽSR)
Horní Dvořiště st.hr. (km 61,097)	ÖBB Infrastruktur AG (ÖBB Infra)
Horní Lideč st.hr. (km 21,110)	Železnice Slovenské republiky (ŽSR)
Hrádek nad Nisou st.hr. (km 21,769)	PKP Polskie Linie Kolejowe S.A. (PKP-PLK)
Cheb st.hr. (km 140,587)	DB Netz AG (DB Netz)
Jindřichov ve Slezsku st.hr. (km 25,694)	PKP Polskie Linie Kolejowe S.A. (PKP-PLK)
Královec st.hr. (km 62,089)	PKP Polskie Linie Kolejowe S.A. (PKP-PLK)
Kraslice st.hr. (km 27,452)	DB Netz AG (DB Netz)
Lanžhot st.hr. (km 11,395)	Železnice Slovenské republiky (ŽSR)
Lichkov st.hr. (km 113,251)	PKP Polskie Linie Kolejowe S.A. (PKP-PLK)
Meziměstí st.hr. (km 92,774)	PKP Polskie Linie Kolejowe S.A. (PKP-PLK)
Mikulovice st.hr. (km 51,500)	PKP Polskie Linie Kolejowe S.A. (PKP-PLK)
Mosty u Jablunkova st.hr. (km 286,534)	Železnice Slovenské republiky (ŽSR)
Petrovice u Karviné st.hr. (km 292,602)	PKP Polskie Linie Kolejowe S.A. (PKP-PLK)
Potůčky st.hr. (km 46,199)	DB RegioNetz Infrastruktur GmbH
Rumburk st.hr. (km 97,690)	DB Netz AG (DB Netz)
Sudoměřice nad Moravou st.hr. (km 14,950)	Železnice Slovenské republiky (ŽSR)
Varnsdorf st.hr. (km 11,459)	DB Netz AG (DB Netz)
Varnsdorf staré nádr. st.hr. (km 13,706)	Deutsche Regionaleisenbahn GmbH (DRE)
Vejprty st.hr. (km 35,391)	DB RegioNetz Infrastruktur GmbH
Velká nad Veličkou st.hr. (km 44,685)	Železnice Slovenské republiky (ŽSR)
Vlářský průmysk st.hr. (km 163,500)	Železnice Slovenské republiky (ŽSR)
Vojtanov st.hr. (km 51,897)	DB Netz AG (DB Netz)
Znojmo st.hr. (km 87,660)	ÖBB Infrastruktur AG (ÖBB Infra)
Železná Ruda st.hr. (0,000)	DB Netz AG (DB Netz)

The list of railway operators interconnected with the Czech Republic is given in Annex "H"..

Information about the service facilities available from railways covered by this Network Statement is given in section 7.

2.3 Network Description

2.3.1 Track Typologies

Basic Characteristics of the Railway Network (as of 31 December 2021)

délka tratí celkem (km)	9 377
jednokolejné (km)	7 337
dvoukolejné a vícekolejné (km)	2 039
Délka elektrizovaných tratí (km)	3 217
AC 25 kV / 50 Hz (km)	1 383
DC 3 kV (km)	1 796
DC 1,5 kV (km)	24
AC 15 kV / 16,7 Hz (km)	14
Délka úzkorozchodných tratí (km)	23
Stavební délka kolejí celkem (km)	15 189
Počet výhybek (ks)	6 719
Počet mostů (ks)	154 422
Celková délka mostů (m)	166
Počet tunelů (ks)	54 072
Celková délka tunelů (m)	7 784
Počet úrovnňových přejezdů (ks)	

2.3.2 Track Gauges

Nationwide and regional railways consist of tracks with standard gauge, defined in accordance with UIC Decree No. 510, i.e. 1,435mm (except for the Osoblaha – Třemešná ve Slezsku regional railway with a narrow track gauge of 760mm).

2.3.3 Stations and Nodes

The description of railway stations and stops in terms of passenger transport is published by the Správa železnic on its website (<https://www.spravazeleznic.cz/cestujici/stanice>).

Information on the equipment of railway stations and stops for the transport of persons with reduced mobility is published by the Správa železnic on its website. (<https://www.spravazeleznic.cz/cestujici/stanice>).

2.3.4 Loading Gauge

The spatial arrangement of the track constructions is defined by the dimensional parameters of the tracks, which shall secure a safe clearance of railway vehicles.

The Z-GC, Z-G2 a Z-GB loading gauges for standard gauge track are based on clearance profile parameters set by the European Committee for Standardisation CEN (EN 15273-3) created on the basis of reference kinematic profiles for GC, G2 a GB vehicles.

The Z-GCZ3 loading gauge for standard gauge track is based on the GCZ3 reference kinematic profile and used for double-decked passenger units. The GCZ3 reference kinematic profile is bigger than the DE3 reference kinematic profile (according to Article D.4.8 ČSN EN 15273-3).

Basic clearance profiles applicable to straight track and track in a curve with a radius of 250m or more are the following:

- a) Basic Z-GC clearance profile is used in new buildings and reconstructions of buildings and facilities on the nationwide as well as on regional railways,
- b) Basic Z-GB, Z-G2 and Z-GCZ3 clearance profiles (alleviations compared to Z-GC) are, used in the assessment of existing buildings (until they are modernised or reconstructed) or during renovations unless the removal of clearance obstructions is economically or technically achievable. Assessment of the Z-GB clearance profile does not replace the assessment of the Z-G2 clearance profile. Assessment of the Z-GCZ3 clearance profile replaces assessments of the Z-GB and Z-G2 clearance profiles.

In curves with the radius less than 250m, the width of basic clearance profiles, including the lateral free spaces thereof, is increased according to internal regulations of Správa železnic.

Only equipment that changes its position concurrently with the vehicle movement (railway brakes in service position, contact wire on electrified railway lines, etc.) can interfere with the clearance profile, provided that contact of this equipment with the designated vehicle parts is precisely defined and contact with other parts of the vehicle is prevented. For the platform edge at the height of 550mm, the provisions of ČSN 73 6320 + Z1 for the given clearance profile are, used.

The Z-GC, Z-G2, ZGB a Z-GCZ3 clearance profiles as well as profiles for free and handling space are listed in Annex "I".

The route codes for combined transport are given on the M11 map. The combined transport line code indicates the number of the maximum profile applicable to the line in question. The code of the loading unit must not be higher than the code number of the line. Combined trains with a standard profile shall have a specified path on the lines on which the code is announced and shall not be diverted to a line with a lower code or to a line without an announced code. The route codes are set and announced by the Správa železnic URMIZA.

2.3.5 Weight Limits

The tracks of nationwide and regional railways are divided into track classes with corresponding speed limits, depending on which of the most efficient rail vehicles of the relevant track class with associated speed they can be used for.

Tracks are classified into the following track load classes A, B1, B2, C2, C3, C4, D2, D3, D4, D4xL, E4 and E5 according to graded contractual limits shown in the table.

Contractual Limits for Track Classification in Track Class

Track Class	Weight per Axle (P) [t]	Weight per metr (p) [t / m]
A	16	5,0
B1	18	5,0
B2	18	6,4
C2	20	6,4
C3	20	7,2
C4	20	8,0
D2	22,5	6,4
D3	22,5	7,2
D4	22,5	8,0
D4xL	22,5 (20)*	8,0 (7,4)*
E4	25	8,0
E5	25	8,8

**) Reference wagons of the special track load class for locomotives are composed of three six-axle (locomotive) wagons and an unlimited number of wagons identical to the D4 track load class reference wagons – see ČSN EN 15528..*

Summary of admissible track load classes with associated speed limit is shown in Annex "B" Table A and in map M07.

2.3.6 Line Gradients

Maximum line gradients are shown in Annex "B" Table A.

2.3.7 Maximum Line Speed

Maximum speed on each line is shown in Annex "B" Table A.

2.3.8 Maximum Train Lengths

Maximum train lengths, standard lengths of passenger train and standard lengths of freight train are shown in TTP of relevant line and in Annex "B" Table A.

2.3.9 Power Supply

On nationwide and regional railways, the following traction systems are used:

- a) DC 3 kV,
- b) AC 25 kV / 50 Hz,
- c) AC 15 kV / 16,7 Hz,
- d) DC 1,5 kV.

Contact points of traction systems DC 3 kV and AC 25 kV / 50 Hz:

Line	Contact point of traction systems
Přerov-Břeclav ²	Říkovice – km 174,800
Přerov-Brno	Nezamyslice – Ivanovice na Hané – km 60,558
Česká Třebová-Brno	Svitavy – Březová nad Svitavou – km 228,109
Kolín-Havlíčkův Brod	Kutná Hora hl.n. (koleje 1 – 6, 11) – km 287,580 – 287,310
Praha-České Budějovice	Benešov u Prahy – Olbramovice – km 132,000
Praha-Plzeň	Beroun – Zdice – km 41,080
Chomutov-Cheb	Kadaň-Prunéřov – Klášterec nad Ohří – km 138,870
Kadaň-Prunéřov – Kadaň	Kadaň-Prunéřov – Kadaň – km 31,500

Contact points of traction systems DC 1.5 kV and AC 25 kV / 50 Hz

Line	Contact point of traction systems
Tábor-Bechyně	ŽST Tábor (průjezd elektrických hnacích vozidel vlastní silou mezi částmi kolejiště elektrizovanými soustavou AC 25 kV a DC 1,5 kV není možný)

Contact point of traction systems at the state border

Foreign IM	Contact point of traction systems	Note
DB Netz	Dolní Žleb st.hr. – Bad Schandau km 11,853	DC 3 kV/AC 15 kV
ÖBB	Sumerrau – Horní Dvořiště km 61,097	AC 15 kV/AC 25 kV
ÖBB	žst. České Velenice km 163,134	AC 15 kV/AC 25 kV
ÖBB	Břeclav st. hr. – Břeclav km 78,000	AC 15 kV/AC 25 kV

² In 2020, the construction of the Traction System Change to AC 25 kV, 50 Hz in the Nedakonice - Říkovice section will begin. The traction system will be converted to 25 kV, 50 Hz in the section Říkovice (except) - Nedakonice (connection to the existing AC system) on the DC section from Přerov to Nedakonice on the Přerov - Břeclav line. For trains from Přerov to Břeclav, it will be necessary to use two-system locomotives AC 25 kV, 50 Hz / DC 3 kV. The last station with the DC 3 kV system on the Přerov - Břeclav line will be the Říkovice railway station. According to the expected construction dates, DC vehicles of 3 kV will be able to travel to Nedakonice until approximately August 2022. This date will be specified with the development of the construction.

Basic interface parameters of the pantograph – TV

Parametr	25 kV, 15 kV	3 kV, 1,5 kV
Material of pantograph skid	pure carbon carbon filled copper max. 35%	pure carbon carbon filled copper max. 40%
Length of the collector head	1950 mm	1950 mm
Width of the collector head	max. 65 cm	max. 65 cm
Static contact force of the pantograph	75 ±15 N	105 ±15 N
Aerodynamic contact force of the pantograph	According to EN 50367 Ed. 2, picture. A.8	According to EN 50367 Ed. 2, picture A.10
Number and distance of pantographs	1-4 pantographs, distance according to Table 4.2.13 TSI ENE, Type A For 3 and more pantographs valid also EN 50367 ed. 2, paragraph. A.1.5, arrangement I.is used too. Longer distances are always used.	1-4 pantographs, distance according to Table 4.2.13 TSI ENE, Type A
Maximal contact wire height	6300 mm	6300 mm
Basic contact wire height	5500 mm	5500 mm
Minimal contact wire height	5000 mm 5100 mm for rail lines with Z-GC clearance profile	4950 mm 5100 mm for rail lines with Z-GC clearance profile
Sections for phase separation	short neutral section according to EN 50367 divided neutral section of arrangement I according to EN 50367 special solution	N/A

Recovery on SZDC electrified lines is permitted at locations marked with appropriate signal devices for electrical operation. Detailed conditions and requirements are given in SŽ PPD-03/2021 Instruction of the railway operator to ensure smooth and safe rail transport. Conditions of EHV / EJ recuperation operation on AC 25 kV 50 Hz and 3 kV DC traction systems, ref. 21114/2021-SŽ-GR-O24 of 30 March 2021.

In the years 2022 - 2024, the section Týniště n.O. (outside) – Častolovice – Solnice will be electrified with AC 25 kV, 50 Hz system.. In this section, the construction of a lossy FKZ (filter-compensation device), which also compensates the power factor, is not considered. For this reason, electric drive vehicles will only be allowed to enter this section if they meet the condition - the value of the power factor on the collector in the range of 0.95 - 1.00 (inductive nature).

See map "M05".

2.3.10 Signalling Systems

The signalling system consists of a uniform system of visible signals in a specified design, shape and colour and audible acoustic signals in a specified design. The signalling system enables easy, fast and unambiguous expression and apprehension of signals and ensures safe operation of rail transport. The basic signals of the signalling system are listed in Annex 1, Part I, of the Decree No. 173/1995 Coll. of the Ministry of Transport from 22 June 1995 by means of which the Railway Transport Rules are issued. Other signals used, are listed in the internal regulations of the railway operator.

Signals are expressed by signal aids (e.g. signalling flag, light, signal board), by hand (visible hand signals), sound (acoustic signals), by means of signal signs of mechanical or light signal devices and permanent signal devices (visible signals) or by verbal instructions.

2.3.11 Traffic Control Systems

Traffic management has several levels - the line level and at the dispatching level.

At the line level, the traffic is managed in assigned sections according to the regulation SŽ D1 ČÁST PRVNÍ Dopravní a návěstní předpis pro tratě nevybavené evropským vlakovým zabezpečovačem (hereafter only „SŽ D1 ČÁST PRVNÍ“) by a station dispatcher, a DOZ and RDP dispatcher and a CDP (Central Dispatcher) line dispatcher. On lines controlled according to the regulation SŽ D3 Předpis pro zjednodušené řízení drážní dopravy (hereafter only „SŽ D3“), the traffic controller is controlled by the line dispatcher, and on lines controlled according to the regulation SŽ D4 Předpis pro řízení drážní dopravy na tratích vybavených radioblokem (hereafter only „SŽ D4“), the RB dispatcher controls traffic.

Above the line level, the control level is the dispatching level. The work of line-level employees is controlled from CDP by an operations dispatcher with operations on multiple lines. He reports directly to the Chief Dispatcher, who is the shift manager of the relevant area. The central dispatcher is the shift manager on the entire network operated by Správa železnic. The dispatchers of IM cooperates with the dispatchers of RUs and together they plan the fluidity and regularity of traffic.

2.3.12 Communication System

The following railway radio systems are operated to control rail transport:

- GSM-R digital radio system in the 900 MHz band,
- analogue SRD radio system in the 450 MHz band,
- analogue simplex radio networks SRV in the 150 MHz band.

See Annex "F" and Map "M10".

2.3.13 Train Control Systems

On nationwide and regional railways, the national LS train system and the ERTMS/ETCS system are used as ATP (Automatic Train Protection) systems.

See map "M09".

National LS train control system is a low-capacity line train control system using a frequency-impulse code for the transmission of information between the station or trackside signalling block systems and the mobile part of the national train protection system on the rail vehicle. Circuits designated for code transmission from the train control system on railways where this equipment is used are considered parts of the station and trackside signalling block devices. Station and trackside signalling block devices provide via the national LS train control system simplified signalling information on the next main or distant signal on longer distance than 1000 m as if there was a Free Sign.

These are Class B equipment according to the Technical specifications for interoperability in terms of security and management within a subsystem Trans-European railway system (TSI CCS) for the Czech Republic.

The ERTMS/ETCS system is a European train control system. This is Class A according to the TSI CCS. A detailed description of the ERTMS / ETCS system, its functions and requirements are to be found in documents referenced in the TSI CCS. See Annex "G" for details on ETCS.

The used ETCS track-side level, its version and contact details for establishing the connection to individual RBCs are listed in TTP Table 04.

2.3.14 Automatic Train Operation

On selected railways of the nationwide and regional network, the automatic train control system (AVV) system is used as the ATO (Automatic Train Operation) system.

For the purposes of the Automated train control system (AVV), a positioning devices, so-called magnetic information points and ETCS balises, are located on the track. Magnetic information

points are mainly located on rails designed for passenger (stopping) trains. On some tracks, it is also necessary to use GPS (Global Position System) for the AVV mobile (vehicle) parts to identify the location. Magnetic information points will no longer be set up on lines with the ERTMS / ETCS track-side system, their function will be replaced by ERTMS / ETCS system elements.

The AVV mobile (vehicle) part must include the route map. Based on the local identification of the train, track description and information transmitted via the train control system and/or inserted by the engine driver, the AVV mobile (vehicle) section ensures smooth and economical train movements.

The deployment of the ATO over ETCS system (AoE - automatic train control over the ETCS system) is being prepared on the Kralupy - Děčín state border line, which uses the ETCS balise system for orientation on the line and the track description is transmitted to the vehicle by the AoE line section. Deployment will be monitored in relation to the definition of the related AoE standard at European level in the new versions of the TSI.

See map "M13".

2.4 Traffic Restrictions

The Správa železnic is not responsible to the applicant for the restriction of train running caused by:

- weather conditions preventing the proper operation of rail transport,
- traffic situations caused by extraordinary events pursuant to Section 49 of the Railways Act, which do not arise from the activities of the Správa železnic,
- the RU, in the event of non-compliance with the conditions for the operation of rail transport on its part,
- conduct of third parties, with "third parties" being those who have no obligation to the Správa železnic,
- the announcement of regulatory measures in railway transport in crisis situations,
- restrictions on the operation of the railway, which have been implemented in accordance with the applicable legislation,

and when indicating a fault on the RU's train by the diagnostic equipment, except where a faulty operation of the diagnostic equipment is demonstrated (see Appendix "J" for a list of diagnostic equipment).

In these cases, the Správa železnic is not obliged to compensate the applicant for the damage incurred.

In the event of a restriction on the RU's train running, the Správa železnic, through no fault of the Správa železnic, shall provide the RU with all available documents at its disposal which are necessary to prove liability for this restriction.

The Správa železnic organizes and manages the operation of rail transport so that rail transport runs safely and smoothly in compliance with the set train timetable. The Správa železnic shall proceed in accordance with the relevant provisions of the RU's internal regulations.

In the event of disruption of traffic for reasons other than an emergency (eg train jamming on the line), the RU who disrupted the flow of traffic is obliged to immediately ensure the elimination of the reason for disruption. The infrastructure manager shall cooperate in removing the reason for the disruption. If the RU does not ensure the elimination of the reason for the disruption or is not able to do so himself, the infrastructure manager may request the cooperation of other RUs in the elimination of the reason for the disruption. The costs associated with the provision of assistance and for all damages and costs incurred as a result of such disruption, both by the RU and other RUs or third parties, shall be borne by the party which caused the disruption. Demonstrable costs incurred by the RU in direct connection with

the removal of the reason for the disruption through the fault of another RU (eg by transporting a stranded train of another RU) shall be reimbursed to this RU by the Správa železnic. The RU who caused the disruption of traffic is subsequently obliged to reimburse these costs to the Správa železnic.

2.4.1 Specialized Infrastructure

Správa železnic restricts the use of allocated railway capacity on the Osoblaha – Třemešná ve Slezsku narrow-gauge regional track only to applicants operating rail vehicles technically competent for rail transport operation on this track.

Správa železnic restricts the use of allocated capacity on the Rybník – Lipno nad Vltavou, Tábor – Bechyně and Štramberk – Veřovice regional track only to applicants operating rail vehicles technically competent to operate rail transport on these tracks.

Správa železnic restricts the use of allocated railway capacity on the nationwide and regional railways in sections equipped with a radio block and where for accessing the track the traction, control and specialised vehicle has to be equipped with a terminal securing full communication and cooperation of the traction vehicle with the radio block. The requirement for a vehicle to be equipped with a terminal may be further specified by issuing an instruction or an internal instruction of the railway operator for the operation of a particular track section.

2.4.2 Environmental Restrictions

The Railway undertaker (hereafter only RU), as a person who uses or operates machines and equipment that are a source of noise or vibration, is in accordance with Act No. 258/2000 Coll., On the protection of public health and amending certain related acts, and Government Decree No. 272 / 2011 Coll., On the protection of health against the adverse effects of noise and vibration, during the operation of rail vehicles and other equipment responsible for compliance with hygienic noise limits set by applicable legislation.

The RU is responsible for not using a rail vehicle whose condition endangers the environment or whose cargo is not properly stored and secured. In the event of poor securing of the cargo, when there is leakage of the transported goods during the parking of the railway vehicles or while they are running (dripping, flying of dust particles, etc.), the RU is obliged to take such measures as will prevent further leakage of the transported goods (securing the transported goods, sprinkling them, reduction of train speed, etc.). In the event that the RU does not take such steps, the Správa železnic reserves the right to limit or stop the running of such a train.

Based on Government Decree No. 152/1992 Coll. on Protective Zones of the Natural Healing Resources of the Spa Town of Františkovy Lázně, it is prohibited to operate transport of substances that could adversely affect natural healing resources in the following sections of the railway: Cheb – Františkovy Lázně – Vojtanov, Tršnice – Františkovy Lázně – Hazlov and Tršnice – Skalná.

For reasons of protection of waters and water resources in the following areas:

- » the surroundings of the Jedlová railway station, which is located in zone II of waters hygienic protection of Chřibská water reservoirs (Decision of Děčín District Court No. 050/4964/99/235/ZF from 30 August 1999),
- » the surroundings of the Letohrad railway station and part of the section between the stations Lanšperk and Letohrad, located in the protection zone of the water source of level II for groundwater sources (decision of the Municipal Authority in Žamberk No. 2929/2009/ZPZE-8/231.8/KOSP-226),
- » the surroundings of the Jablonné nad Orlicí railway station and part of the section between the stations Jablonné nad Orlicí and Těchonín, located in the protection zone of the water source of level II for groundwater sources (decision of the Municipal Authority in Žamberk No. 11185/2010/ZPZE-7/231.8/SCHP-70),

it is prohibited to:

- » stand off trains, train units or individual wagons containing harmful substances, except for vehicles with propellants for their own operation,
- » establish warehouses, including temporary, with harmful and dangerous substances, and handle them,
- » establish waste disposal sites, place litter and waste freely.

For reasons of prevention of potential environmental hazards in the cases of repeated leakage of harmful substances from railway vehicles (e.g. leakage of petroleum substances), Správa železnic will define a section of station track designated for waiting or standstill of such railway vehicles in the Rules and Regulations of the Station. Waiting or standstill of such railway vehicles is only allowed for the RU in these specified places

Refueling of railway vehicles outside stationary service facilities of the service station is possible only under the conditions set by the valid legislation of the Czech Republic in the area of environmental protection, in particular § 39 of Act No. 254/2001 Coll. subsequent regulations, including its implementing regulations and internal regulations of the infrastructure manager. In this case, the RU is obliged in particular to have an emergency plan drawn up in accordance with the above legislation and approved by the relevant water authority. Správa železnic publishes a list of recommended locations for refueling of rail vehicles outside stationary service facilities at the railway operation portal.

Lines 320 00 Praha-Libeň – Praha hl.n. and 327 00 Praha hl.n. - Balabenka branch are intended only for passenger trains to maintain hygienic noise limits between 22:00 and 06:00. At this time, the running of freight trains on these lines is prohibited.

2.4.3 Dangerous Goods

Based on Government Decree No. 152/1992 Coll. on Protective Zones of the Natural Healing Resources of the Spa Town of Františkovy Lázně, it is prohibited to operate transport of substances that could adversely affect natural healing resources in the following sections of the railway: Cheb – Františkovy Lázně – Vojtanov, Tršnice – Františkovy Lázně – Hazlov and Tršnice – Skalná.

2.4.4 Tunnel Restrictions

In accordance with the provisions of Commission Regulation (EU) No 1303/2014 of 18 November 2014 on the technical specification for interoperability relating to "safety in railway tunnels" of the European Union rail system (hereinafter "TSI SRT"), operation in tunnels of longer than 1,000 m designed in accordance with the SRT TSI only allowed:

- Category A rolling stock for passenger transport (including passenger locomotives) on lines where the maximum length of the tunnel or the distance from the tunnel portals to the evacuation and rescue point in the tunnel or between evacuation and rescue points in the tunnel does not exceed 5 km.
- category B rolling stock for passenger transport (including passenger locomotives) in all tunnels, regardless of the length of the tunnels.
- freight locomotives and multiple units which are designed to carry loads other than passengers, such as mail or freight, for operation in all tunnels, regardless of the length of the tunnels. Locomotives intended for hauling freight and passenger trains fall into both categories and must meet the requirements of both categories.
- track-side motor machinery in mode of operation for operation in all tunnels on lines falling within the scope of the SRT TSI, regardless of the length of the tunnels.

The list of tunnels designed in accordance with the above regulation on the railways where the Správa železnic is the allocator is given in the following table:

Tunel	Line	Required category of rolling stock according to TSI SRT
Ejpovický I, II	360 00 Beroun – Plzeň hlavní nádraží	kategorie A kategorie B

The conditions for the rolling stock category are laid down in Commission Regulation (EU) No 1302/2014 of 18 November 2014 on the technical specification for interoperability relating to the subsystem rolling stock - locomotives and passenger rolling stock of the rail system within the European Union.

In the Ejpovice – Plzeň hl.n. rail section it is possible to operate rail transport only by engine and vehicles with control wagons equipped with the functional GSM-R radio station. Because of the use of fixed track, the operation of rail vehicles without a closed toilet flushing system is also prohibited in this section. If the train is equipped with a toilet without a closed flushing system, it is the responsibility of the RU to ensure that the toilet is not used while driving through the tunnel. Steam locomotive movement in this section is allowed with a serviceable boiler and fire on the grate only if no tractive power is generated and under the conditions laid down for the operation of steam locomotives in Article 5 of Správa železnic's Directive No. 71 Fire Protection Measures for the Operation of Steam Locomotives on the Railway Operated by Správa železnic.

2.4.5 Bridge Restrictions

A drawbridge over the Vraňansko-hořínský navigable canal is installed on the regional railway No. 403 00 Vraňany - Lužec nad Vltavou. During the lifting of the bridge to allow ships to pass, the movement of rail vehicles on the regional railway is prohibited.

2.5 Availability of the Infrastructure

2.5.1 Restriction of Railway Operation

Railway operator shall prepare a draft plan for the restriction of the railway operation or its part for the purpose of carrying out maintenance or repair works on the track and activities related to the construction of the railway or its facilities or other activities endangering safe or fluent rail transport if the expected restriction time exceeds 24 hours. The draft plan for the restricted operation of the railway or its part is approved by the Transport Infrastructure Access Authority after a due discussion according to the Rail Act.

On the Infrastructure Operation Portal, Správa železnic publishes updated monthly information on planned operating restrictions of the individual tracks and their parts. The RU is entitled to compensation of the difference of the directly expended costs related to the securing substitute transport for interrupted public passenger rail transport due to restrictions of the railway operation planned pursuant to Section 23b (3) and the savings related to the interruption of rail transport and any claims for reimbursement of these costs under the contract on public passenger transport services. The railway operator shall pay for this difference if the applicant proves the amount of demonstrably expended costs related directly to securing substitute transport and the amount of savings related to the interruption of rail transport. If the RU is entitled to reimbursement of expended costs directly related to securing substitute transport on the basis of the public passenger transport service contract, it shall also demonstrate the amount of that claim.

In addition, according to the Rail Act, the railway operator is entitled to restrict the operation of the railway due to the activities not listed in the approved Restriction Plan such as:

- a) ensuring serviceability of the track after its disruption by natural or exceptional events,
- b) maintenance or repair works on the track, unless the expected restraint period exceeds 24 hours or there is no restriction of the rail transport operation on the track, or
- c) maintenance or repair works on the track, if the conditions under Letter b) are not fulfilled but the carrying out of such activities must not be postponed.

In such cases, the railway operator shall, without undue delay, notify the affected RUs, railway owner and the Transport Infrastructure Access Authority and state the reasons of such a procedure and the expected limitation period. If legal requirements are not complied with, the Transport Infrastructure Access Authority shall require the railway operator to resume railway operation and sets a reasonable period of time for it to do so.

Správa železnic is also entitled to limit the allocation of the railway capacity in the event of exceptional events, adverse weather conditions, natural events, regulatory actions in rail transport in crisis situations, etc. See also Chapter 6.3.3.

Movements of rail vehicles for the purpose of regular measurements and test movements for technical safety test of a line that are required by Decree No. 177/1995 Coll., on Construction and Technical Regulations for Railways, as amended, are according to Section 23 (b) of the Rail Act a reason entitling Správa železnic for the time necessary to restrict the operation of the railway or parts thereof.

For more information see Chapter 4.3.2.

2.5.2 Personnel Limitation of Infrastructure Availability

Railway operators publish on their website information on the extent of the closure of transport service.

2.6 Infrastructure Development

2.6.1 Main projects of infrastructure development

The Správa železnic publishes information on the main infrastructure development projects on its website www.spravazeleznic.cz in the section Constructions / Contracts> Overview of projects. The Správa železnic also operates an interactive map on its website with an overview of individual buildings on the Správa železnic's network.

2.6.2 ETCS Development

The development of ETCS is described in Annex "G".

2.6.3 Construction of long tunnels

As part of the development and modernization of the railway network, the Správa železnic carries out the construction of tunnels longer than 1,000 m. In accordance with the provisions of the SRT TSI, only tunnels designed in accordance with these TSIs may be operated for fire safety reasons:

- Category A rolling stock for the carriage of passengers (including passenger locomotives) on lines where the maximum length of the tunnel or the distance from the tunnel portals to the evacuation and rescue point in the tunnel or between evacuation and rescue points in the tunnel does not exceed 5 km.
- Category B rolling stock for passenger transport (including passenger locomotives) in all tunnels, regardless of the length of the tunnels.
- freight locomotives and multiple units which are designed to carry loads other than passengers, such as mail or freight, for operation in all tunnels, regardless of the length of the tunnels. Locomotives intended for hauling freight and passenger trains fall into both categories and must meet the requirements of both categories.
- track-side motor machines in transport mode for operation in all tunnels, regardless of the length of the tunnels.

The list of tunnels longer than 1,000 m, which are currently designed according to the SRT TSI, on the tracks where the Správa železnic is the allocator is given in the following table:

Tunel	Line	Expected year of operation	Required category of rolling stock according to TSI SRT
Tunely na trati Praha - Kladno/letiště VH ^{*)}	Praha - Kladno/letiště VH	2028	Category A Category B
Tunely na trati Nemanice-Ševětín	Nemanice-Ševětín	2028	Category A Category B
Berounský tunel	Smíchov-Beroun	2036	Category B
Krušnohorský tunel (HSL)	Praha – Drážďany	2038	Category B
Litoměřický tunel (HSL)	Praha – Drážďany	2045	Category B
Tunel Oucmanice a tunel Hemže	Ústí nad Orlicí-Choceň	2034	Category A Category B
Střížkovský tunel (VRT)	Praha – Drážďany	2030	Category B
Líbeznický tunel (VRT)	Praha – Drážďany	2030	Category B
Ledčický tunel (VRT)	Praha – Drážďany	2030	Category B
Tunel Nová Dubeč (VRT)	Praha – Brno	2030	Category B
Hruškové Dvory (VRT)	Praha – Brno	2031	Category B
Helenín (VRT)	Praha – Brno	2031	Category B
Lesní Hluboké (VRT)	Praha – Brno	2031	Category B
Kývalka (VRT)	Praha – Brno	2031	Category B
Popůvky (VRT)	Praha – Brno	2031	Category B
Troubsko (VRT)	Praha – Brno	2031	Category B
Rousínov (VRT)	Brno – Olomouc	2050	Category B

^{*)} On the line Prague - Kladno / VH airport, according to the current schedule, a transitional period will apply, when the section Výstaviště - Dejvice will be electrified and partly in the tunnel, but the adjoining tunnel section Dejvice - Veleslavín will not be completed. During this transitional period, the sets will run on the existing non-electrified line in the section Dejvice - Veleslavín. No special requirements for rolling stock will apply during this transitional period.

The conditions for the rolling stock category are laid down in Commission Regulation (EU) No 1302/2014 of 18 November 2014 on the technical specification for interoperability relating to the subsystem rolling stock - locomotives and passenger rolling stock of the rail system within the European Union.

Steam locomotives will not be possible in the underground and fully covered stations Praha-Dejvice, Praha-Veleslavín, Praha-Dlouhá Míle and Praha-Václav Havel Airport on the Praha-Kladno / VH line due to fire safety and ventilation of the stations.

3 Access conditions

3.1 Introduction

Section 3 of this Network Statement describes the terms and conditions related to access to the railway infrastructure for the minimum package of access services (train paths) where the Správa železnic is allocation body.

These terms and conditions also apply to the part of the freight corridors which pass through the railway infrastructure managed by Správa železnic.

3.2 General Access Requirements

3.2.1 Conditions for Applying for Capacity

A request for the allocation of railway capacity may be submitted to the Správa železnic by a legal or natural person who holds a valid license or a person who does not hold a valid license (non-RU applicant) and has fulfilled all the conditions stipulated by law. The allocated railway capacity may be used only by the applicant to whom the capacity has been allocated and who is the holder of the license, or the license holder who has made a declaration in accordance with Chapter 4.3.2), if the applicant is without a valid license.

An applicant who intends to submit an application for the allocation of capacity for the purpose of operating passenger rail transport without a public service contract in passenger transport according to the directly applicable European Union regulation governing the economic balance test shall notify this fact to ÚPDI and allocation body no later than 18 months before the date

of entry into force of the timetable. The allocation body shall not allocate capacity for the purpose of operating passenger rail transport without a public service contract in passenger transport unless the applicant notifies its intention. The allocation body will also not allocate track capacity until the decision of the ÚPDI takes legal effect, if a request for an assessment of economic balance has been submitted.

3.2.2 Conditions for Access to the Railway Infrastructure

Rail transport on nationwide or regional railways may be operated, in compliance with the conditions laid down by the Rail Act, by a legal or natural person which:

- a) is a resident of a Member State of the European Union;
- b) holds a valid licence;
- c) has the allocated railway capacity;
- d) has concluded a contract with the railway operator for the operation of rail transport, unless the railway operator and the RU is one person;
- e) is financially eligible to operate rail transport. Financial capacity is proved by the RU to the Rail Authority and it is understood as an ability to financially secure the commencement and due operation of rail transport for at least 12 months. The RU is not financially eligible if its bankruptcy is settled by an insolvency court's decision to declare bankruptcy of the debtor's assets or to authorise a reorganisation or where the insolvency court has decided to cancel the bankruptcy because the debtor's property is completely insufficient for the creditors' satisfaction or the RU owes tax arrears, insurance premiums, social security penalty payments, a contribution to the state employment policy or general health insurance premiums;
- f) has a paid insurance of liability for damages caused by the operation of railway transport and premiums during the entire period of operation of rail transport, while on the railways operated by Správa železnic the minimum amount of insurance benefit is set at CZK 50,000,000;
- g) has agreed the price for the use of railway for train according to the price regulations and the payment method;
- h) has negotiated with the operator of the railway special technical and operating conditions for the transport of exceptional consignments or loading capacity of the railway vehicle.

For more details about the contract, see Chapter 3.3.2.

3.2.3 Licences

In the Czech Republic, the Railway Authority grants a license for the operation of rail transport on national and regional railways (see Chapter 1.6). In the Czech Republic, a license issued by the competent authority of another Member State of the European Union in accordance with Directive 2012/34 / EU of the European Parliament and of the Council of 21 November 2012 on the creation of a single European railway area is also valid.

The licence may be issued under the terms of the Rail Act, i.e. if the applicant:

- a) is over 18 years of age and, in the case it is a natural person, is fully legally competent,
- b) is without criminal report,
- c) is professionally competent,
- d) is financially illegible,
- e) has not seriously violated labour-law regulations,
- f) has not seriously breached customs regulations, in the case of an authorisation to operate rail freight transport,
- g) is insured as of the date of commencement of rail transport operation in the case of an obligation to compensate for the damage caused by such operation and
- h) is a resident of the Czech Republic.

For more information visit www.ducr.cz.

3.2.4 Safety Certificate

The RU must have, on the date of commencement of rail transport on the national or regional railways, a safety certificate (single safety certificate) covering the national and regional railways or part of them. Safety certificates issued by the Railway Authority (see chapter 1.6) consist of:

- a) part certifying actions taken by the RU to meet the requirements of the internal organisational structure and management system for rail transport and the establishment of a rail safety management system, which is a set of organisational and technological measures for the safe operation of rail transport,
- b) part certifying measures taken by the RU in order to meet the conditions of professional competence of persons providing railway transport operation, conditions stipulated by the Rail Act on operation of railway vehicles and specific technical equipment for the issue of internal regulations for the operation of railway transport, operation of railway vehicles, operation of specific technical equipment, requirements for the professional competence and knowledge of persons providing rail transport operations and the way they are reviewed, including a system of regular training.

A RU who holds a RU certificate issued by an authority of another Member State of the European Union received upon fulfilment of the legislative requirements a certificate from the Drážní úřad with only the part referred to in Subparagraph (b) above.

Since 1 November 2020, the European Railway Agency (ERA) has issued the Single Safety Certificate to RUs or, in the event that the RU will operate rail transport only in the Czech Republic, the Railway Authority. This certificate is issued in the form of a single document. Based on discussions with the Railway Authority, the validity of the Single Safety Certificate issued for the territory of a neighboring Member State of the European Union may be extended to operations up to stations near the border in the Czech Republic bordering the state for whose territory the Single RU Certificate is issued. The delimitation of the sections of lines on which such traffic to stations near the border is permitted is given by the cooperation agreement between the Drážní úřad and the national safety authority of the neighboring Member State of the European Union.

For more information, visit (www.ducr.cz) or EU Agency for Railway ERA (https://www.era.europa.eu/applicants/applications-single-safety-certificates_en).

3.2.5 Insurance

A RU who operates rail transport on a nationwide or regional railway is obliged to comply with the requirements of the Rail Act in relation to financial eligibility and insurance:

- a) financially ensure the proper operation of rail transport throughout the period of validity of the licence,
- b) as of the date of commencement of the railway transport, negotiate insurance for liability for damages from the operation of railway transport, pay the insurance premiums and have this insurance agreed and premiums paid for the whole period of operation of railway transport, subject to a minimum amount of indemnity set at CZK 50,000,000 for railways operated by Správa železnic.

3.3 Contractual Arrangements

3.3.1 Framework Agreement

Správa železnic in accordance with Article 14 of Commission Regulation (EU) 2016/545 does not offer and does not newly conclude framework agreements for reservation of railway capacity.

3.3.2 Contracts with RUs

The safe operation of railway transport requires the cooperation of all parties involved. In this process, these are the RU, the rail operator and the railway owner. Their mutual relations are defined by a bilateral agreement.

For a RU which enters a railway for the purpose of operating rail transport, this is a contract for the operation of rail transport on the nationwide and regional railways concluded by the RU and the railway operator.

The RU is obliged to operate rail transport in accordance with a contract for operation of railway transport concluded with the railway operator. The railway operator is obliged to provide the RU with contractually negotiated services in standard quality and on a non-discriminatory basis.

The RU and the operator of a railway on which the traffic is to be operated may not deviate from the contents of this Statement when concluding or amending the contract for operation of railway transport.

Should there be a dispute between the railway operator and the RU regarding the compliance of the contract proposal with the Rail Act, the ÚPDI will decide upon request of one of the contractual parties whether the contract proposal is in conflict with the Rail Act.

3.3.2.1 Contract between RU and Správa železnic as allocation body and infrastructure operator

Business conditions are negotiated between the Správa železnic and the RU prior to the commencement of the operation of rail transport, by concluding a bilateral agreement..

The contract between the RU and the Správa železnic regulates the mutual rights and obligations of the contracting parties in the allocation of track capacity, the operation of railway transport, the use of service facilities operated by the Správa železnic and the use of services directly related to the operation of railway transport, operated and provided by the Správa železnic.

The contractual conditions for the use of the track on regional lines leased to a third party are governed by separate contracts between the RU and the lessee of the relevant regional line.

Standard format of the contract between the RU and the Správa železnic as capacity allocator and railway operator:

S M L O U V A
o provozování drážní dopravy
.....

Kapitola I	Provozování drážní dopravy
Článek 1	Přidělování kapacity dráhy
Článek 2	Jízdní řád a plánování jízd vlaků
Článek 3	Omezení provozování dráhy
Článek 4	Předpisové podmínky
Článek 5	Zaměstnanci dopravce
Článek 6	Drážní vozidla
Článek 7	Mimořádné zásilky
Článek 8	Omezení jízdy vlaků
Článek 9	Mimořádné události
Kapitola II	Zpoplatnění výkonů a služeb
Článek 10	Ceny za přidělení kapacity dráhy
Článek 11	Ceny za použití dráhy
Článek 12	Ceny za poskytnuté služby

Článek 13	<i>Evidenční výkony a služby</i>
Článek 14	<i>Fakturace</i>
Kapitola III	<i>Další ujednání</i>
Článek 15	<i>Odpovědnost za škody nebo jiné újmy</i>
Článek 16	<i>Sankce za narušení provozování drážní dopravy</i>
Článek 17	<i>Ukončení smluvního vztahu</i>
Článek 18	<i>Ostatní ustanovení</i>
Článek 19	<i>Závěrečná ustanovení</i>
Příloha 1	<i>Vnitřní předpisy provozovatele dráhy</i>
Příloha 2	<i>Sumární přehled fakturovaných cen za použití dráhy jízdou vlaku</i>
Příloha 3	<i>Sumární přehled sankce za nevyužitou nebo odřeknutou přidělenou kapacitu</i>

The list of internal regulations of the railway operator from Appendix 1 of the standard format of the contract between the RU and the Správa železnic as the capacity allocator and the railway operator is given in Annex "O".

The contract between the RU and the Správa železnic as capacity allocator and railway operator is concluded for an indefinite period by default. The validity and effectiveness of this contract can then be terminated in the following ways:

- a) by written agreement of the contracting parties;
- b) written notice by any of the contracting parties. The notice period is 3 months and begins on the first day of the calendar month following the delivery of the notice to the other contracting party. However, if the RU requests the Správa železnic in writing to enter into a new contract for the operation of rail transport no later than the end of the first month of the notice period, the Správa železnic is obliged to send the RU a draft of the new contract for the operation of rail transport within 15 calendar days of receiving this request. If an agreement is not reached between the RU and the Správa železnic on the content of the new contract on the operation of rail transport by the end of the notice period of the existing contract, and at the same time, if any of the contracting parties requests the ÚPDI before the end of the notice period of the existing contract to decide on the content of the new contract on the operation of railway of transport within the meaning of § 34g paragraph 6) of the Act on Railways, then the notice period of the existing contract is established and does not run from the day on which this request for a decision of the ÚPDI was demonstrably sent, and ends no earlier than 15 calendar days after the day on which the legal force of the decision of the ÚPDI according to the provisions of § 34g, paragraph 6) of the Act on Railways;
- c) by written withdrawal from the contract by one of the contracting parties, if the Správa železnic loses the ability to operate the national railway and regional railways that are the subject of the contract, or if the RU loses the ability to operate rail transport on the national railway and regional railways that are the subject contracts. Withdrawal from the contract becomes effective on the day following the day of its delivery to the other contracting party or on the day on which the loss of this competence of the Správa železnic or the RU is determined in advance by the railway administrative body.

The Správa železnic also reserves the right to terminate the contract for the operation of rail transport by withdrawing from the contract also in the event that the RU does not present to the Správa železnic a valid and effective insurance contract or a document issued by an insurance company on valid liability insurance of the RU for damage or other harm caused by the operation, even after repeated requests of railway transport in the sense of chapter 3.2.2 of this Network statement on the railway to verify the duration of the liability insurance.

The contracting parties are obliged to settle mutual obligations within 30 calendar days after the end of the contractual relationship.

In the event that the RU holds a Single Safety Certificate, which is valid in the Czech Republic only for operations to stations near the border, the validity of the contract will be limited only to the relevant border line sections.

3.3.2.2 Contract between RU and PKP CARGO INTERNATIONAL a.s. as infrastructure operator

PKP CARGO INTERNATIONAL as the operator of the regional railway Milotice nad Opavou - Vrbno pod Pradědem, allows the operation of rail transport on the relevant regional railway only to RUs who meet the conditions for the operation of rail transport under the Rail Act, based on a contract for rail transport upon fulfillment of the conditions stipulated by the contract. The contract can be requested in writing at the company's address PKP CARGO INTERNATIONAL as, Betonářská 580/14, Muglinov, Ostrava, postal code 702 62, or by e-mail at: legislativa@pkpcargointernational.com or via the data box - mailbox ID: gv4cgeh.

3.3.2.3 Contract between RU and PDV Railway a.s. as infrastructure operator

PDV RAILWAY a.s., as the operator of the regional railways Sokolov – Kraslice and Trutnov hl.n. – Svoboda nad Úpou, , allows the operation of rail transport on the relevant regional railway only to RUs who meet the conditions for the operation of rail transport under the Rail Act, based on a contract for rail transport upon fulfillment of the conditions stipulated by the contract. The contract can be requested in writing at the company's address PDV RAILWAY a.s., Blahoslavova 937/62, 400 01 Ústí nad Labem, or by e-mail at: info@pdvr.cz or via the data box – ID schránky: ht5cd2d .

3.3.3 Contracts with non-RU Applicants

A condition for allocating infrastructure capacity to a non-RU applicant is meeting legal requirements by the applicant and the conclusion of the Contract for allocation of capacity between Správa železnic and the non-RU applicant. The subject of this contract is to regulate the mutual rights and obligations of the contracting parties in requesting and allocating railway capacity and its subsequent use.

On freight corridors (see Chapter 1.7.1) the specific rules contained in Regulation 913/2010/EU, as well as other specific rules published in the Corridor Information Document of each corridor (CID), apply. These specific rules apply only to international freight trains operating under the rules of a particular freight corridor.

Standard format of contract between the non-RU applicant and Správa železnic:

*SMLOUVA
o přidělení kapacity dráhy žadateli, který není držitelem platné licence*

<i>Článek 1</i>	<i>Předmět smlouvy</i>
<i>Článek 2</i>	<i>Vymezení pojmů</i>
<i>Článek 3</i>	<i>Práva a povinnosti smluvních stran</i>
<i>Článek 4</i>	<i>Cena a platební podmínky</i>
<i>Článek 5</i>	<i>Závěrečná ustanovení</i>

3.3.4 General Terms and Conditions

The Správa železnic does not issue general business conditions or apply the European General Terms and Conditions (EGTC) separately. The conditions of access to the railway are regulated by the valid legislation, this Network statement and the contract. The Správa železnic applies the Uniform Terms and Conditions, which are listed in Annex "P" of this Network Statement.

3.4 Specific Access Requirements

3.4.1 Rolling Stock Acceptance

The basic rules for the operation of rail vehicles on nationwide and regional railways are laid down by the Rail Act.

Competence in the field of vehicle approval is also exercised by the European Union Agency for Railways to the extent and in accordance with Regulation (EU) 2016/796 of the European

Parliament and of the Council of 11 May 2016 on the European Union Railway Agency and repealing Regulation (EC) No. 881/2004 and any implementing rules.

On a national or regional railway, the RU may only operate such a railway vehicle,

- a) for which a permit to place it on the market has been issued by the railway administrative office or the European Union Agency for Railways,
- b) which is registered in the register of railway vehicles or a similar register of another member state or in the European register of vehicles,
- c) which is technically compatible with this track in accordance with the technical specification for interoperability and with the data contained in the track register according to the directly applicable regulation of the European Union regulating the railway infrastructure specification register and
- d) for which, in the case of its connection with another rail vehicle, this connection is made safely in accordance with the technical specification for interoperability and the system for ensuring the safety of rail transport.

The Railway authority shall register a railway vehicle at the request of its owner in the register of railway vehicles,

- a) if the railway vehicle has been issued with a permit to put it on the market by the railway administrative office or the European Union Agency for Railways and
- b) if the area of operation according to § 31a paragraph 2 letter c) in relation to a railway vehicle, a railway on the territory of the Czech Republic.

For more information, visit www.ducr.cz

A RU whose activity caused a damage to the environment is required to take immediate remedial action. If this is impossible or non-effective for the RU, it is obliged to compensate Správa železnic for environmental damage in another way (alternative performance) or to compensate Správa železnic for this damage in cash.

In order to prevent potential environmental danger, Správa železnic defines in its internal regulations the operational conditions and the specific measures to prevent or minimise potential environmental damage. These operational conditions and measures are binding on all natural and legal persons involved in railway operations.

Only rail vehicles with wheelsets maintained in accordance with ČSN EN 15313 can be operated on railways operated by Správa železnic.

The RU is obliged to ensure that the rail vehicle is inspected after the following occurs

- derailment of the vehicle in which at least one wheel has left the top of the rail head even for a short period of time, or has passed a rigid object higher than 3cm (except for the stopping or dropping of the railhead in rail brakes)
- the impact of the vehicle on an obstruction at a speed exceeding 5.5 km/h even through buffers,
- exceeding the maximum weight of the load in relation to the car's length or floor area, overloading of the wagon, chassis, wheelset or wheels by more than 5% above the permitted load,
- free fall of a compact solid object on the wagon floor with the energy corresponding to the fall of an object weighing at least 30kg from a height of 3m,
- drawing or pushing the vehicle by shearing or by applying force to parts other than specified,
- violent removal of plastic deformations of the carcass or underbody,
- passing through a hump in a gravity yard with a vehicle whose restraint is limited or prohibited,
- exposure to aggressive media,

by a qualified person after each handling of the rail vehicle and subsequently set the conditions for further transport. These conditions shall be sent to Správa železnic by the RU.

3.4.2 Staff Acceptance

Požadavky na zdravotní způsobilost zaměstnanců zajišťujících provozování dráhy a drážní Requirements for the medical fitness of employees responsible for the operation of railways and rail transport are stipulated by Decree No. 101/1995 Coll., and stated in the Rules for the Health and Professional Competence in the Operation of a Railway and Railway Transport, as amended. Requirements for the professional competence of persons conducting the railway vehicle are laid down by Decree No. 16/2012 Coll., on the professional competence of persons conducting the railway vehicle and persons carrying out inspections, examinations and tests of specified technical equipment and on the amendment of Decree of the Ministry of Transport No. 101/1995 Coll. issuing the Rules for the Health and Professional Competence in the Operation of Railway and Railway Transport, as amended.

The specific requirements for the professional competence and knowledge of the persons responsible for the operation of rail transport and the method of their verification, including the system of regular training, shall be defined by each RU as an internal regulation for the operation of rail transport.

Specific requirements for the professional competence and knowledge of persons providing activities related to the organisation and management of rail transport and the way of their verification, including the system of regular training, shall be laid down by an internal regulation.

Access into the operated railway infrastructure, into premises and buildings of Správa železnic is granted to persons with a valid staff ID of the railway transport operator.

All other persons must apply for permission to enter the railway infrastructure, premises and buildings of Správa železnic. The permit is issued by Správa železnic in accordance with Správa železnic regulation Ob1, part II. The application procedure and information for the authorisation of the licence can be found at <https://www.spravazeleznic.cz/dodavatele-odberatele/vstup-do-provozovane-zdc>.

The RU, in accordance with the provisions of § 35 para. p) of the Railways Act, before the train runs, it shall forward to the Správa železnic's IS the license number of each driver who drives an active traction unit on the train. The RU transmits this information to the Správa železnic either via the IS ComposT web interface or via this IS data interface. Details for the use of the web interface are given in the WebComposT user manual, which is available to RUs on the IS ComposT website (<https://compost.spravazeleznic.cz/webcompost/login>). The description of the data interface for IS ComposT is given to the RUs on the Railway Operation Portal (<https://provoz.spravazeleznic.cz/Portal/ViewArticle.aspx?oid=881854>). This obligation is not a condition for access to the railway and its non-compliance by the RU will not prevent the use of the railway by the RU or in any other way affect the relations between the Správa železnic and the RU. The license number is used exclusively for the needs of the Drážní úřad; employees of Správa železnic do not have access to such data in the Správa železnic's IS that would enable closer identification of the license number holder. In the event of failure to provide the license number of each driver driving an active traction unit on the train, in accordance with the first sentence, the Správa železnic shall immediately notify the Drážní úřad of this fact.

3.4.3 Exceptional Consignments

The consignment is considered exceptional any of the participating railway operators is required to adopt and implement specific technical or operational measures due to its external dimensions, weight or nature, taking into account the parameters used for the rail vehicles and railways affected by transport.

Exceptional consignments (hereinafter referred to as "EC") are:

- a) consignments exceeding loading gauge (hereinafter referred to as "ELG"), vehicles exceeding the reference profile:
 - » a consignment which, in its dimension, exceeds the loading gauge or the required loading width limitation,
 - » consignments of combined transport load units exceeding the applicable loading gauge, whose code is higher than the code of the relevant route or which are transported on trains not designed for combined transport (the relevant train code is not provided) or load units are not loaded on approved coded wagons for combined transport,
 - » a rail vehicle that exceeding with its kinematic or static outline the reference profile corresponding to the clearance profile of the track, unless the Rail Authority has provided otherwise.
- b) Consignments of excessive weight:
 - » the weight of the consignment exceeds the specified track load class on the respective railway (per axle or regular meter of the vehicle);
 - » the weight of the load exceeds the vehicle's maximum load rating (load gauge grid/ additional data grid).
- c) Consignments of excessive length:
 - » solid load units on two wagons with swivelling bolster / sliding swivelling bolster,
 - » consignments of flexible load units of more than 36m in length on more than one wagon.
- d) Other consignments:
 - » a rail vehicle that has been approved for operation under specific technical and operation conditions by the Rail Authority (as an exceptional consignment);
 - » consignments loaded on wagons with more than 8 axles.
- e) Other consignments with respect to the following regulations: CIM, AVV, UIC Loading Directive and Decree IRS 50502:
 - » a rail vehicle transported on its own wheels, which itself is the subject of a contract of carriage, not labelled using the RIV/RIC/TEN or in the loading capacity grid (e.g. CZ/ČD) under the conditions of the AVV General Contract of Use for Wagons, Annex 11, Article 2.1 or 2.2,
 - » a cargo which is not stored and secured in accordance with international regulations (e.g. the UIC Loading Directive) and if no comparable alternative securing is available,
 - » consignment that is to be transloaded to ships (ferry) if it does not comply with the conditions stated in the AVV General Contract of Use for Wagons (AVV, Annex 11, Annex 1)
 - » a cargo consignment that cannot be transported to its destination station without transshipment if it weighs more than 25 tonnes or is loaded on a well wagon (applies only for transshipment to rails with a different track gauge),
 - » other consignments not mentioned above resulting from the European standards, Agreements and Conventions (e.g. UIC) .

Exceptional consignments may only be transported after the conditions specified by the operator have been met. The RU is obliged to discuss EC transport on nationwide and regional railways operated by Správa železnic with Správa železnic – URMIZA (Central Registry of Exceptional Consignments) according to Správa železnic Regulation No. D31, which defines rules for discussing, organising and assessing the possibility of EC transport. Správa železnic

Regulation No. D31 applies the provisions of Decree IRS 50502, which regulates the approval procedures in EC international transport.

EC transport in international transport has to be discussed and harmonised in advance with the cooperating RUs on railway infrastructure.

Decree IRS 50502 is published by UIC on: <https://www.shop-etf.com/en/>.

Contact information:

Správa železnic, státní organizace
Odbor řízení provozu– URMIZA
Dlážděná 1003/7, 110 00 Praha 1 – Nové Město

Workplace:

Praha 8, Křižíkova 2
tel.: +420 972 244 761
+420 972 244 405
fax: +420 972 244 690
e-mail: urmiza@spravazeleznic.cz

Contacts to operators of other regional railways are listed in Chapter 1.6.

3.4.4 Dangerous Goods

"Dangerous goods" means materials and objects of which the carriage is prohibited under the RID (Regulation concerning the International Carriage of Dangerous Goods by Rail) or authorised only under certain conditions.

The transport of dangerous goods by rail is legislated by the RID, and the following national legislation:

- Act No. 266/1994 Coll., on Railways, as amended.
- Government Regulation No. 1/2000 Coll., on Transport Regulation for Public Railway Freight Transport, as amended.
- Decree No. 376/2006 Coll., on ensuring the safety of railway operations and rail transport and procedures in the event of emergency incidents on railways.
- Decree of the Ministry of Transport No. 100/1995 Coll. that stipulates the conditions for operation, construction and production of specified technical equipment and their specification (Rules of specified technical equipment).
- Government Regulation No. 208/2011 Coll., on Technical Requirements for Transportable Pressure Equipment.

In accordance with the RID provision, Správa železnic has developed the Internal Emergency Plans for the following train stations:

- | | | |
|---------------------------|------------------------|------------------------|
| • Beroun seř.n. | • Hněvice | • Most nové nádraží |
| • Brno-Maloměřice | • Horní Dvořiště | • Nové Sedlo u Lokte |
| • Břeclav přednádraží | • Hradec Králové hl.n. | • Nymburk seř.n. |
| • Bohumín-Vrbice | • Hranice na Moravě | • Olomouc pravé předn. |
| • Česká Třebová směr.sk. | • Cheb | • Opava východ |
| • České Budějovice seř.n. | • Chomutov | • Ostrava Kunčice |
| • Český Těšín | • Jihlava | • Ostrava levé n. |
| • České Velenice | • Kolín | • Ostrava pravé n. |
| • Děčín hl.n. | • Kralupy nad Vltavou | • Otrokovice |
| • Domažlice | • Krnov | • Pardubice hl.n. |
| • Havlíčkův Brod | • Liberec | • Plzeň seř.n. |
| | • Lovosice | • Praha-Libeň |
| | • Mladá Boleslav hl.n. | • Protivín |

- Přerov přednádraží
- Sokolov
- Strakonice
- Studénka
- Tábor
- Trutnov hl.n.
- Třinec
- Turnov
- Týniště nad Orlicí
- Ústí nad Labem západ
- Valašské Meziříčí
- Veselí nad Lužnicí
- Zábřeh na Moravě
- Znojmo

See also Chapter 4.7.2.

3.4.5 Test Trains and Other Special Trains

In-service tests of rolling stock may be performed with or without traffic measures. Tests while driving with traffic measures are considered to be tests where:

- a) the RU himself requests the elaboration of transport arrangements;
- b) the RU requires a rolling stock technical safety test (TBZ);
- c) the required running time does not correspond to the smooth running of the train;
- d) the RU requests to travel in excess of the permitted route parameters;
- e) there is a decision of the Railway Authority for the given journey requiring the elaboration of transport measures;
- f) there are other circumstances which require the issue of traffic measures.

If it is necessary to provide transport arrangements for the driving test, the RU must request that such arrangements be drawn up in the application. The railway operator shall process the application and draw up transport measures within 30 days of the delivery of all necessary documents. In the case of repeated journeys with parameters identical to journeys for which a traffic measure has already been issued, the railway undertaking shall process the application and prepare a traffic measure within 7 days of the delivery of all necessary documents.

3.4.6 Rides from local or siding to national or regional railways

The holder of a valid license for the operation of rail transport on a local railway or siding or a RU who does not hold a safety certificate may also operate rail transport on a national or regional railway, if it is a point of contact of interconnected railways.

The holder of a valid license to drive a railway vehicle on a local or siding track may also drive a railway vehicle on a national or regional track if it is a point of contact between interconnected railways.

The conditions for entering the railway station on a national or regional railway, which is located immediately behind the contact of this railway with a local railway or siding, the Správa železnic negotiates with the RU who operates rail transport on such a local railway or siding and does not meet the conditions describes in chapter 3.2.2, the contract on the operation of rail transport at the railway junction. Standard format of the contract between the RU on the local railway or siding and the Správa železnic:

SMLOUVA

o provozování drážní dopravy na styku vzájemně zaústěných drah

Článek 1	<i>Plánování jízd</i>
Článek 2	<i>Předpisové podmínky</i>
Článek 3	<i>Zaměstnanci dopravce</i>
Článek 4	<i>Drážní vozidla</i>
Článek 5	<i>Omezení provozování dráhy</i>
Článek 6	<i>Mimořádné události</i>
Článek 7	<i>Odpovědnost za škody nebo jiné újmy</i>
Článek 8	<i>Ukončení smluvního vztahu</i>
Článek 9	<i>Závěrečná ustanovení</i>

In the case of a RU running from a local railway or siding to a national or regional railway, the Správa železnic considers the railway station into which the local railway or siding to be the point of contact of the interlocking railways. However, it respects any restrictions set by the RU's license.

4 Capacity allocation

4.1 Introduction

Railway capacity, i.e. the ability to use rail routes required for certain parts of the track over a certain period of time, is expressed by the number of rail routes that can be constructed over a given period of time with given technical, operational and personnel equipment and with maintaining necessary quality of transport.

The railway capacity of multi-track sections is defined by Správa železnic for each track separately according to the specified railway traffic organisation.

In accordance with Section 32 of the Rail Act, Správa železnic allocates the capacity of the railway on nationwide railway and on state-owned regional railways. The maximum time range (the time between the departure from the first point and the arrival at the last point on the Správa železnic network) of the allocated railway capacity is 20 hours. An exception may be granted by the capacity allocator only if a one-time application is submitted for one day only.

On lines that are included in the European Railway Network for Competitive Freight Transport (ERNCF) according to Regulation 913/2010 (see chapter 1.7.1), the Corridor OSS (C-OSS) can also allocate track capacity. The conditions and procedures for the allocation of track capacity on the European freight corridors are described in Annex "R". These conditions and procedures are published by individual corridors in the Corridor Information Document (CID). More information on the pages of individual corridors or on the website of the Správa železnic in the section dedicated to ERNCF (see chapters 1.7.1 and 4.10).

4.2 General Description of the Process

4.2.1 Capacity request

In order to ensure access to information systems for submitting capacity requests or to make data exchange available between the RU's IS and IS KADR, it is necessary to conclude with the Správa železnic before submitting the application:

- A contract with non-RU applicant (see chapter 3.3.3) in the case of a non-RU applicant or
- Contract between RU and Správa železnic as allocation body and infrastructure operator (see chapter 3.3.2.1) in the case of a RU applicant.

Annual Timetable Path Requests and Late Annual Timetable Path Requests shall be submitted by the applicant to the Správa železnic:

- electronically via IS RNE PCS, in accordance with the instructions issued by the infrastructure manager for operating these applications;
- by means of electronic data exchange between the RU's IS and the KADR IS, according to the conditions set out on the Railway Operation Portal. The railway operator will inform the RU on the Railway Operation Portal about the availability of data communication between IS KADR and the RU's IS;

- via the IS KADR web form located on the Railway Operation Portal (<https://provaz.spravazeleznice.cz/KADR>), in accordance with the instructions issued by the railway operator for the operation of this IS;
- in case of unexpected failure of IS KADR, regular and late applications to the annual timetable can be submitted in writing on the prescribed form "FOREIGN STUDY FORM / ROUTE APPLICATION FORM" (see Appendix "E") in Czech or English via e-mail:
 - a. data box: ucchjm;
 - b. e-mail: epodatelna@spravazeleznice.cz ..

The application sent by e-mail must be provided with an electronic signature based on a qualified electronic signature certificate or a qualified electronic signature of a person authorized to act on behalf of a legal entity (see chapter 3.3).

The date and time shall be considered as delivery of the application:

- submission of the application for track capacity and route in IS KADR,
- submission of route request in IS RNE PCS,
- on the stamp of the Správa železnic's registry office in the case of a written request.

The applicant submits a request for ad hoc allocation of capacity and for route modification (see Chapter 4.8.1) to the Správa železnic in the Czech language electronically, namely:

- via the IS KADR web form located on the Railway Operation Portal (<https://provaz.spravazeleznice.cz/KADR>), in accordance with the instructions issued by the railway operator for the operation of this IS;
- by means of electronic data exchange between the applicant's IS and the KADR IS, according to the conditions located on the Railway Operation Portal;
- for interstate applications also via IS RNE PCS. The railway operator will inform the applicant about the start of data communication between IS RNE PCS and IS KADR on the Railway Operation Portal.
- in the event of an unexpected failure of the IS KADR, an ad hoc application submitted within 3 working days can also be requested by telephone. In this case, the RU must immediately submit its application in writing in the Czech language directly or through an authorized person, by e-mail to the address:
 - a. interstate applications - oss@spravazeleznice.cz,
 - b. national applications to the Chief Dispatcher of the relevant area of traffic management - see the railway operation portal (<https://provaz.spravazeleznice.cz/Portal/ViewArticle.aspx?oid=1818322>).

The form for a written request in the event of an unexpected outage of the IS KADR is published on the Railway Operation Portal (access to ŽDC -> KADR).

The date and time shall be considered as delivery of the application:

- submission of the application for track capacity and route in IS KADR,
- submission of route request in IS RNE PCS,
- the moment of delivery of the data message to the SŽ data box,
- the moment of registration of the e-mail at the SŽ filing office.

IS RNE PCS is an international information system for coordinating route requests for RUs and other applicants, railway operators, capacity allocators and European Freight Corridors (RFC). This system optimizes international route coordination by ensuring that route requirements and offers are harmonized by all stakeholders. In addition, RNE PCS is the only tool for publishing a binding offer of pre-prepared routes (PaP) and reserve capacity and for managing international capacity requests on RFC corridors.

Access to PCS is free. The user account can be obtained through RNE PCS support: support.pcs@rne.eu.

More information can be found at <http://pcs.rne.eu>.

4.2.2 Mandatory data in the capacity request

The applicant is required to state in the application the following:

- a) business name, identification number, unique company number (so-called RICS code) and registered office of the applicant;
- b) description of the required railway capacity, i.e. a train path that establishes a logical connection of the starting and destination point (alternatively the contact point of two interconnected railways) and the indication of path points needed to identify the path in a clear manner. In this path there must not be any sections of transport points operated multiple times, except for the cases specifically agreed by the railway operator;
- c) proposal of a timetable of the required train path, including the requirements for waiting at certain transport points and the reasons for such waiting;
- d) type of train conducted on the required train path, including information on its maximum regular weight, maximum speed, length, track class, container profiles, braking mode, maximum braking percentage and rolling resistance;
- e) type of traction, series and number of traction railway vehicles, their function, the requirement for planned change of traction vehicles, etc.;
- f) time range of the required railway capacity (i.e. the train path usage calendar – daily/on certain days, regularly/as needed, or in the period from-to);
- g) type of rail transport operated, including information whether the train is operated on the basis of a public service obligation;
- h) stating the required tariff and non-tariff notes into the annual timetable including their time and space limitations;
- i) type and extent of required services;
- j) other requirements of the applicant for rail vehicle movement and the occupation of tracks surrounding the station in which the assigned path starts or ends, or handling at wayside stations or the minimum required technological time of waiting at the border station, etc.;
- k) in the case of the ad hoc application for railway capacity allocation, also stating the technology used at the destination transport point and wayside transport point (see Annex "M") if it is required for waiting or operation, which means a requirement for any occupation of station tracks before or after the departure of the train or if the RU requests additional cooperation from the railway operator during the waiting;
- l) exceptional situations on the train, if these are known to it at the time of the submission of the application;
- m) in the case of a written application, the signature of the authorized person under the contract (see Chapter 3.3) or the person (persons) authorized to act on behalf of the company according to the Commercial Register.

If any of the parameters stated in Sections (a) to (f) are changed, the capacity allocator shall assess, within the process of drawing up the annual timetable, whether there has been a change in the application under Chapter 4.5.1.4 and whether the due application is changed for belated.

The information referred to in points (a) to (m) must be identical in one application. If it is not possible to submit the application so that this condition is met (eg different travel days in parts of the required route, stops at stations and stops only on certain days), the application must be divided into several applications so that this condition is met.

If the applicant requests the creation of turns between trains at the final station, he is obliged to submit his requests as part of the timetable, but no later than the deadline for applicants' comments (see chapter 4.5.1.5). He submits a list of turnover requirements to the relevant processor of the station technology. The contact for the processor of the station technology is listed on the Railway Operation Portal (in the section Kontakty -> Seznam kontaktů na

technologii). In the event of a change to the timetable, he will indicate the requirements for turns as part of the request for track capacity. If it is not possible to incorporate the turnovers, the station technology processor will immediately inform the applicant of this fact. The form available on the Railway Operation Portal (<https://provaz.spravazeleznic.cz/Portal/ViewArticle.aspx?oid=2072314>) is used to request the creation of turns between freight trains.

If the applicant requests the creation of connecting links between freight trains, he is obliged to submit his requests as part of the timetable, but no later than the deadline for accepting late requests for track capacity in the case of the construction of an annual timetable (see chapter 4.5.2) or by the deadline deadlines for requests to change the timetable in the event of a timetable change (see chapter 4.5.1.6). He sends his requests by e-mail to the contact person of the Správa železnic for the annual timetable (see chapter 1.6). The form available on the Railway Operation Portal (<https://provaz.spravazeleznic.cz/Portal/ViewArticle.aspx?oid=2072314>) is used to request the creation of connecting links between freight trains. If the applicant requests the creation of connections between passenger trains, the applicant shall send the contact employee a list of connections at individual stations, no later than 10 calendar weeks before the start of the timetable or 4 calendar weeks before the timetable change takes effect. The contact for the processor of connecting links in passenger transport is listed on the Railway Operation Portal (in the section Pomůcky GVD -> Pomůcky ročního JŘ -> Vydávané odborem jízdního řádu Správy železnic -> Příklad mezi vlaky osobní dopavy).

In accordance with the TAF/TAP TSI implementation process, a list of mandatory and optional elements of the individual messages used in the Path Application dialogue will be published on the Infrastructure Operation Portal from the date of publication.

The RU shall provide Správa železnic the following documents at the latest on the day of the commencement of rail transport operation within the allocated rail capacity:

- a) RU's certificate valid for the period of time to which it has the allocated railway capacity,
- b) document proving the conclusion of the liability insurance contract for damages caused by the operation of railway transport on the allocated railway capacity in the minimum amount according to Chapter 3.2.5, including a document proving that the insurance has been paid.

4.2.3 Capacity allocation

Správa železnic will allocate railway capacity if:

- a) the applicant has submitted and attested its application in accordance with this Network Statement,
- b) the applicant has a valid licence or has fulfilled all legislative requirements for applicants without a valid licence,
- c) the capacity of the railway allows it,
- d) the applicant concluded a contract with Správa železnic according to Chapter 3.3.2 or 0,
- e) the RU has concluded a contract on the performance system according to Chapter 5.7,
- f) for interstate routes the condition stipulated in Chapter 4.5.1.1 was met.

The response to a request for track capacity may be the allocation of track capacity in the form of one or more train paths or timetables.

The allocation of capacity to the annual timetable and for ad hoc requests is carried out by the Správa železnic via IS KADR.

In the event that the applicant did not meet all the conditions for the allocation of railway capacity given by this Network statement at the time of submitting a regular or late application for allocation of railway capacity, he must meet these conditions by the deadline for late applications at the latest.

For regular requests to the annual timetable and late requests to the annual timetable submitted by a non-RU applicant, the non-RU applicant must indicate the RU that will use the allocated capacity (business name, identification number, RICS code and seat of the RU), in the application for interstate routes as well as cooperating RUs (trading company, RICS code and seat of the RU) on relevant neighboring infrastructures, no later than the deadline for accepting late requests for the annual timetable. By the same date, the applicant must deliver a written statement from the RU stating that, in the event of allocation of capacity, it will actually use this capacity (see Appendix "D").

For timetable change requests and ad hoc requests submitted by a non-RU applicant, the non-RU applicant must indicate the RU that will use the allocated capacity (business name, identification number, RICS code and seat of the RU), for requests for interstate routes and cooperating RU (trading company, RICS code and registered office of the RU) on the relevant neighboring infrastructures, and deliver a written declaration by the RU that, in the event of allocation of capacity, it will actually use this capacity (see Appendix "D") before the allocation of capacity. Designation of the RU and delivery of its written statement according to the previous sentence is a condition for the allocation of track capacity.

4.3 Reserving Capacity for Temporary Capacity Restrictions

4.3.1 General Principles

Správa železnic, as an organisation exercising the function of the owner of state-owned railways, RUs out maintenance and repair works on the railway in accordance with the provision of Section 20 of the Rail Act in the extent necessary for its operability and secures development and modernisation of nationwide and regional railways necessary for ensuring transport needs of the state and transport servicing in its regions.

For this reason, Správa železnic implements an extensive railway network development and maintenance programme. The implementation of this programme has significant impacts on the extent of available railway capacity, both by closing part of the infrastructure and by limiting speed on affected sections of the track. The list of planned temporary capacity railway restrictions ("TCR") planned to be implemented by Správa železnic is published on the Správa železnic website (<https://www.spravazeleznic.cz/dopravci/vyluky>).

Správa železnic shall notify applicants for railway capacity of such DOK (already published in the second publication regime pursuant to Annex VII) which, due to the impact of restrictions, expects to include reduced capacity allocation within the framework of the annual timetable by 11 December 2021. In the case of such DOKs, Správa železnic considers that, during the capacity allocation, due to the specific parameters of a particular DOK, a situation will occur in which it will not be possible to satisfy all received requests for infrastructure capacity allocation.

4.3.2 Deadlines and Information Provided to Applicants

For TCRs published within the rules set out in paragraph 12 of Annex VII with a requirement for the construction of an exclusive timetable, the Správa železnic shall prepare an offer of train paths for RU.

The draft of exclusion timetable will be submitted to RUs through the information system Centrální systém výluk at least 60 days before the date of the planned restriction of track operation in the form of a draft Rozkaz o výluce. RUs will be informed of this fact by e-mail. In the event of an event with an approved request for the construction of a výlukový nákresný jízdní řád, a draft of výlukový nákresný jízdní řád will also be sent to them, at least 45 days before the date of the planned restriction of track operation.

The allocated capacity may be adjusted or even withdrawn if this is necessary in connection with the implementation of actions from the ÚPDI approved TCR plan under the conditions specified in § 23b of the Railways Act and in § 21a and § 22 of Decree No. 173/1995 Coll. RUs will be informed immediately of the need to adjust the capacity already allocated, but no later

than 60 days before the start of the event. Any removal of track capacity will be done in a non-discriminatory manner. The removal of track capacity will be carried out in accordance with the text of Commission Delegated Decision (EU) 2017/2075 of 4 September 2017 replacing Annex VII to Directive 2012/34 / EU of the European Parliament and of the Council establishing a single European railway area to take into account:

1. commercial and operational restrictions on the applicants for track capacity concerned and minimize the risk of permanent relocation of certain parts of the traffic to less environmentally friendly modes of transport;
2. transport services on the basis of a public service contract for the carriage of passengers, which does not preclude a temporary transfer to another mode of transport while maintaining the necessary scope of transport services.

Therefore, priority will be given to taking capacity from the segment whose temporary transfer to other modes of transport or diversion routes is the easiest to operate and the risk of a permanent shift to a less environmentally friendly mode of transport is the lowest.

When adjusting the allocated capacity in accordance with the provisions of the previous paragraph, the RU shall endeavor to minimize the deviation from the allocated timetable. The adjustment of allocated capacity will be assessed individually in the planned TCRs according to the composition of trains with allocated capacity in the line section concerned under the conditions of Delegated Commission Decision (EU) 2017/2075 of 4 September 2017 replacing Annex VII of Directive 2012 / 34 / EU on the creation of a single European railway area, and in Article 14 (8) of Regulation (EU) No 913/2010 of the European Parliament and of the Council of 22 September 2010 concerning a European rail network for competitive freight, and in assessing the following: aspects:

- 1) Significant share of regional passenger transport (in the public service obligation / on the commercial risk of the RU):
 - a) the possibility of compensation;
 - b) the possibility of partial reimbursement;
 - c) no replacement is possible;
- 2) Significant share of freight transport:
 - a) the possibility of an acceptable diversion in compliance with the necessary standards;
 - b) diversion is not possible;
 - c) partial deflection;
 - d) maintaining the necessary serviceability;
 - e) possible frontloading;
- 3) Significant share of long-distance passenger transport (in the public service obligation / on the commercial risk of the RU):
 - a) the possibility of compensation;
 - b) the possibility of partial reimbursement;
 - c) the possibility of diversion;
 - d) the possibility of connecting sets.

In this case, applicants are entitled to use the replacement railway capacity or to a refund of the price paid for the allocation of railway capacity in accordance with the provisions of Chapter 4.8.4.

The above mentioned procedure includes the following steps:

Step	Deadline
Consultation of the TCR's annual plan with applicants prior to the first publication pursuant to Annex VII	24 months *)
Publication of the annual plan of TCR in the mode of first publication according to Annex VII	24 months *)
Coordination of designated TCRs with the connected networks	18/13,5 months *)
Consultation with applicants prior to the second publication according to Annex VII	12 months *)

Step	Deadline
Publication of the annual plan of DOK in the mode of the second publication according to Annex VII	12 months *)
Consideration of possible changes to the TCR annual plan after the second publication with applicants	5 months *)
Správa železnic's application for approval of the TCR plan at ÚPDI	4 months *)
Low-impact TCR publication pursuant to Article 12 of Annex VII	4 months *)
Informing RUs of the routes offered for closures with an approved design requirement of the lockout schedule	4 months **)
Informing RUs of the planned TCR	90 days **)
Submission of a draft exclusion timetable in the form of a draft Rozkaz o výluce	60 days**)
Submission of draft lockout schedule (if designed)	45 days **)
Deadline for comments by RU on the draft of výlukový nákresný jízdní řád (if it is constructed)	5 working days****)
Statement of the Správa železnic on the comments of the RU on the proposal of the výlukový nákresný jízdní řád, if these comments were not complied with in whole or in part	10 days****)
Deadline for measures taken by RU for the výlukový rozkaz	25 days**)
Publish of výlukový rozkaz	20 days**)
Publish of výlukový nákresný jízdní řád (if it is constructed)	15 days**)

*) Before allocating capacity to the annual timetable – see Chapter 4.5.1.5.

***) Before the start of the closure.

****) From the date of delivery of the draft Exclusive Drawing Schedule.

*****) From the date of delivery of the RU's statement on the draft timetable

For the needs of diagnostics and measurement of infrastructure and where possible, Správa železnic establishes a reserve capacity of 10% of the technical capacity of the railway on the relevant track section.

This railway capacity may be used by:

- a) applicants transporting material, equipment and technical devices for railway diagnostics and measurement, maintenance, renewal and track capacity enhancement or carrying out the above mentioned activities themselves,
- b) applicants whose railway capacity allocated by Správa železnic is limited by maintenance, renewal and track capacity enhancement works on the railway, and only to the extent reducing the limitation if this capacity is not used in accordance with (a);
- c) other applicants if this capacity is not used according to Clause (a) or (b).

In the case of an application for the allocation of this railway capacity, the Správa železnic shall take into account its purpose and adjust the priorities for its allocation accordingly. The Správa železnic may reject the applicant's request for reserve capacity of the track for maintenance, renewal and increase of track capacity if this does not fulfill its purpose.

4.4 Impacts of Framework Agreements

The Správa železnic does not offer or conclude framework contracts for the reservation of railway capacity in accordance with Article 14 of Commission Regulation (EU) 2016/545, on procedures and criteria for framework agreements for the allocation of railway infrastructure capacity.

4.5 Path Allocation Process

4.5.1 Annual Timetable Path Requests

This process is divided into a logical sequence of partial phases that are adapted to the agreed time schedule of the annual timetable.

The individual partial phases include:

- receipt of an application to the annual timetable,

- submission of a proposed plan for designing train paths,
- application of the applicants' suggestions,
- railway capacity allocation.

In order to draw up the annual timetable, Správa železnic offers technical capacity of the route, which is based on the equipment of the railway infrastructure. On the basis of this application, Správa železnic will allocate route capacity to the applicant for the validity period of the annual timetable.

Technical capacity of the route indicates the maximum scope of traffic, taking into consideration requirements for the required quality and prescribed maintenance. When determining technical capacity of the route, full staffing and operation of temporarily closed facilities that may be put into service if necessary, are assumed.

The route and timetable of the train shall be determined by the railway operator as part of the railway capacity assessment before the subsequent capacity allocation. Relevant data outputs for the annual timetable are provided by Správa železnic to the RUs free of charge electronically on the Infrastructure Operation Portal.

As part of the allocation of rail capacity to the annual timetable, the Správa železnic offers a application for railway capacity allocation to the annual timetable.

If the applicant receives a response to one submitted request in the form of multiple data schedules, solely for reasons of the Správa železnic, then the second and all other data schedules belonging to one application are assigned with the product "Regular request for allocation track capacity to the annual timetable due to a reason on IM side '.

4.5.1.1 Submission of the application

The applicant shall request for route capacity allocation at the railway operator in accordance with provisions stated in Chapter 4.2.1.

The application must contain all the information defined in Chapter 0.

International applications must be harmonised in advance with cooperating applicants on neighbouring railway infrastructures. This is an essential condition for accepting this application for design. The IS RNE PCS serves to harmonise the application between applicants. The allocation of route and line capacity on a border section is subject to the agreement of the adjacent railway capacity allocator (infrastructure manager) based on the confirmation that the same application for the allocation of the route and line on the interconnected border section of the neighbouring infrastructure has been submitted by the follow-up applicant and that this application would be granted.

The applicant may also apply for the allocation of the offer route. The railway operator does not guarantee the allocation of the offer route to the applicant.

4.5.1.2 Receipt of the route application

The Správa železnic will accept the route applicant's request via the information system. If the application is incomplete or contains factual errors, this may be a reason for its rejection and return. The re-submission of this application is considered as a new application including an updated date of receipt.

Upon receipt of the request, the infrastructure manager shall assess the capacity of the infrastructure. As part of the assessment of track capacity, it shall allocate a tender route or construct a train path and submit a draft train timetable to the applicant. In the case of an interstate route, the draft train timetable is coordinated by the railway operators and jointly submitted to the applicants. IS RNE PCS is used to coordinate train timetable proposals.

4.5.1.3 Acceptance of train timetable draft

The Správa železnic will publish the draft timetable in passenger transport within the deadline according to Chapter 4.5.1.5 on the railway operation portal and Správa železnic's website. The draft timetable in passenger transport is published for the purpose of its discussion with the Ministry of Transport, regional authorities and RUs. The proposed route is submitted by the Správa železnic to the applicant via the RNE PCS IS or via data communication with the RU's system. The Správa železnic may submit more than one timetable proposal to the RU, but no more than one proposal for each required day of travel.

The Správa železnic will publish information on the availability of the draft timetable in freight transport within the deadline according to Chapter 4.5.1.5 on the railway operator's portal. Applicants who have data communication in the process of creating an annual timetable have a proposal in data form in their IS.

The applicant shall assess the draft train timetable and provide comments on or approve the proposed routes. It will do this via data communication with IS KADR or for national routes also in writing, for interstate routes at the same time by IS RNE PCS. Written comments or written consent will be sent by e-mail to the Správa železnic, Timetable Department. In the case of an interstate route, which is provided by the applicants in mutual cooperation, comments on the route are resolved with the lead applicant, who will then apply them to the railway operators. Details of these processes are provided in the RNE IS manuals for RNE PCS.

The applicant must send his comments or acceptance of the routes by the deadline for the applicants' comments on the draft annual timetable. If the applicant does not send his comments within this deadline, the proposed routes are considered accepted.

The schedule of meetings on the submitted proposal in all regions of the Czech Republic is published on the railway operator's portal.

The comments of the applicant will be processed by the railway operator by the deadline for allocating railway capacity for applications to the annual timetable.

If the request for track capacity cannot be complied with even after the coordination of all received requests (see chapter 4.5.4), the railway undertaking shall communicate this information to the applicant, stating that there is no alternative to deal with his request. The applicant can then re-submit his application in new terms and new conditions for the design of the train path. The re-submission of this application shall be considered as a new application, including its date of receipt.

After the acceptance of the route by the applicant, the Správa železnic will allocate the track capacity of this route. It then processes the proposed route and its data into the aids of the annual timetable.

When processing applications for the annual timetable, the deadlines defined by European directives, the Railways Act and its implementing regulations as currently in force, as well as the deadlines agreed by the RNE, the European Railway Operators' Organization and the railway capacity allocators set out in Chapter 4.5.1.5.

4.5.1.4 Change of the application

A change of the application is considered to be a change of the parameters of the application by the applicant to such an extent that the railway operator has to change the parameters of the already constructed route. The decision whether a change in the request parameters will cause a change in the route design is made by the railway undertaking.

If the applicant changes the parameters of his application for passenger transport in the period after the deadline for receiving regular applications, but before the deadline for receiving late applications, the application solves two consecutive steps:

- cancellation of the original application,
- creation of a request for a new route - late requests with a new deadline.

4.5.1.5 Deadlines for designing the annual timetable

Deadlines for designing the annual timetable 2024

Regular request for the annual timetable	Applications accepted until	11 April 2023
	Presentation of the draft of the annual timetable for passenger transport	9 June 2023
	Draft of the annual international timetable published until:	3 July 2023
	Draft of the annual timetable for freight transport	3 July 2023
	Deadline for objections by applicants in freight transport	4 August 2023
	Deadline for objections by applicants in passenger transport	4 August 2023
	Deadline for railway capacity allocation	30 November 2023
The start of validity of the annual timetable		10 December 2023
The end of validity of the annual timetable		14 December 2024

4.5.1.6 Application for capacity allocation to a change of the annual timetable

To change the annual timetable, the Správa železnic offers the following ad hoc products:

- a request for long-term ad hoc capacity allocation of a passenger train, where the time from receipt of the request to the first required train departure day is 45 or more working days (including the day of request) and at the same time 20 or more travel days are required in one request,
- a request for a long-term ad hoc allocation of freight capacity of a freight train, where the time from receipt of the request to the first required train departure day is 20 or more working days (including application day) and at the same time 20 or more travel days are required in one request.

To change the annual timetable, train paths are constructed in the remaining free capacity of the track, taking into account the already allocated routes.

Submission of applications to change the annual timetable is resolved in accordance with the provisions of Chapter 4.5.3.1.

Deadlines for application to a change of the annual timetable 2024

Change of the annual timetable	Requests for passenger trains accepted until	3 April 2024
	Requests for freight trains accepted until	12 May 2024
	Change valid from	9 June 2024

4.5.2 Late Annual Timetable Path Requests

This process solves applications to the annual timetable, which were applied after the deadline for annual timetable path requests or were changed after this deadline.

As part of the allocation of railway capacity after the deadline for annual timetable path requests, the Správa železnic is offering the product a late application for the allocation of railway capacity to the annual timetable.

In the event that the applicant receives a response to one submitted request in the form of multiple data schedules, solely for reasons of the Správa železnic, then the second and all other data schedules belonging to one request are allocated with the product "late request for allocation railway capacity to the annual timetable due to reason on IM side".

For late requests, train paths are constructed in the remaining free capacity of the track, taking into account the already allocated paths.

Routes designed for late requests have a lower priority than routes designed for regular requests for the allocation of track capacity to the annual timetable.

The provisions of Chapter 4.5.1 shall apply mutatis mutandis to the submission and acceptance of a route request, the acceptance of a draft annual timetable and the change of a request.

Deadlines for late annual timetable path requests for timetable 2024

Late request to the annual timetable	Request accepted from	12 April 2023
	Requests for passenger transport accepted until	4 September 2023
	Requests for freight transport accepted until	4 September 2023
	Deadline for railway capacity allocation	30 November 2023
The start of validity of the annual timetable		10 December 2023
The end of validity of the annual timetable		14 December 2024

4.5.3 Ad-Hoc Path Requests

As part of the ad hoc route capacity allocation, Správa železnic offers the following products:

- application for long-term ad hoc passenger route capacity allocation where the period from the receipt of the application to the first required departure day of the train is 45 or more working days (including the submission date of the application) and concurrently 20 days of movement or more is required in one application,
- application for long-term ad hoc freight route capacity allocation where the period from the receipt of the application to the first required departure day of the train is 20 or more working days (including the submission date of the application) and concurrently 20 days of movement or more is required in one application,
- application for ad hoc route capacity allocation for "more than 3 days" where the period from the receipt of the application to the first required departure day of the train is three or more working days (including the submission date of the application);
- application for ad hoc capacity allocation for "less than 3 days" where the period from the receipt of the application to the first required departure day of the train is less than three working days (including the submission date of the application)
- application for ad hoc route capacity allocation for the purpose of technical and safety tests of rail vehicles,
- application for ad hoc route capacity allocation for test driving of vehicles of an unapproved type or driving faster than the maximum track limit,
- application for ad hoc route capacity allocation for maintenance of Správa železnic infrastructure,
- application for ad hoc route capacity allocation due to the temporary capacity restrictions,
- a request for ad hoc allocation of track capacity for other reasons on the part of the Správy železnic.

An application for an ad hoc allocation of the capacity of the infrastructure due to the temporary capacity restrictions is not necessary in cases where the capacity is restricted pursuant to Section 23c (3) a) the Railways Act.

The route and the timetable of the train shall be determined by the railway operator as part of the assessment of the application for railway capacity.

For long-term applications, ad hoc applications and applications for "more than 3 days", the railway operator shall design and ad hoc routes with solving the conflicts.

In the case of applications for "less than 3 days", it is up to the railway operator to decide whether to allocate ad hoc routes with solving the conflicts (e.g. allocate offer routes in a designed position), or to allocate routes in reserve capacity to resolve conflicts as part of operational traffic management.

4.5.3.1 Submission of the application

The applicant applies for ad hoc railway capacity allocation electronically:

- using data communication from its own IS to the IS of the railway operator – IS KADR. Before the initiation of data communication, the railway operator has to agree with the correctness of the established data communication. Conditions for connecting the IS data communication of the applicant shall be communicated by the railway operator;
- through the IS KADR web application form that is to be found on the Infrastructure Operation Portal (<http://provoz.spravazeleznic.cz/KADR>);
- for international applications also using IS RNE PCS. Správa železnic will inform about the commencement of the data communication between IS RNE PCS and IS KADR on the Infrastructure Operation Portal.
- in the event of an unforeseen outage of the IS KADR, an ad hoc application submitted within 3 working days can also be requested by telephone. In this case, the RU must immediately submit its application in writing in the Czech language directly or through an authorized person, by e-mail to the address:
 - a. international requests - oss@spravazeleznic.cz,
 - b. national requests to the Chief Dispatcher of the relevant traffic management area (<https://provoz.spravazeleznic.cz/Portal/ViewArticle.aspx?oid=1818322>).

The application must contain all the information defined in Chapter 0.

International applications must be harmonised with cooperating applicants on neighbouring railway infrastructures. This is an essential condition for accepting this application for design. The allocation of route and line capacity on a border section is subject to the agreement of the adjacent railway capacity allocator (infrastructure manager) based on the confirmation that the same application for the allocation of the route and line on the interconnected border section of the neighbouring infrastructure has been submitted by the follow-up applicant and that this application would be granted.

The applicant may also apply for the allocation of the offer route. The railway operator does not guarantee the allocation of the offer route to the applicant.

In the case of an application for capacity applied for "less than 3 days", the applicant submits this application in a period exceeding 12 hours before the departure of the train from the starting point/access point to Správa železnic infrastructure. The applicant may also apply in a shorter time, however Správa železnic does not guarantee the timely settlement of its application.

4.5.3.2 Receipt of the application for route capacity

The Správa železnic shall accept the applicant's request for ad hoc allocation of track capacity through the information system. If the application is incomplete or contains factual errors, this may be a reason for its rejection and return. Re-submission of this application is considered as a new application, including an updated date of receipt.

The request for the allocation of track capacity is assessed by the Správa železnic only within the free track capacity remaining after the completion of the track capacity allocation process

in the annual timetable and after the completion of all previous ad hoc requests for track capacity allocation.

During the entire process of allocating track capacity, the Správa železnic works closely with other railway operators in the Czech Republic, who are responsible for preparing the train timetable.

For mutual cooperation in the allocation of track capacity, if a train path is to cross the network of one capacity allocator, a joint commission shall be set up, if necessary, composed of representatives of the capacity allocators concerned. Upon receipt of the application, the Správa železnic will assess the capacity of the track, within which it will determine the train timetable and submit it to the applicant as a proposal. The Správa železnic may submit more than one timetable proposal to the applicant, but not more than one proposal for each required day of travel.

In the event of a conflict in the construction of the timetable, the request received earlier shall take precedence. In the concurrence of applications, it shall preferentially allocate unused railway capacity to the applicant who intends to provide transport services.

The infrastructure manager shall ensure a coordinated train path offer for interstate capacity requests in cooperation with infrastructure managers and track capacity allocators on other infrastructures. The allocation of track and route capacity on the border section shall be subject to the assent of the capacity allocator (infrastructure manager) of the neighboring infrastructure based on confirmation that an identical request for capacity and route capacity has been submitted on the adjacent border section of the neighboring infrastructure and that the request will be granted.

4.5.3.3 Acceptance of draft route

The applicant shall assess the proposed route and provide objections against the proposed train timetable or approves the proposed route.

The applicant must send its objections or acceptance of the route

- within 24 hours after receiving the route offer, but no later than 2 hours before the proposed departure time from the departure station for capacity application for "more than 3 days",
- within 2 hours after receiving the route offer, but no later than 2 hours before the proposed departure time from the departure station, for capacity applications for "less than 3 days",

otherwise the draft of the railway operator is considered accepted.

The applicant has also an option of accepting the route offer in advance when the application is filed. In this case, after designing the train timetable, track capacity is automatically allocated.

Applicant's objections shall be handled by the railway operator as soon as possible, up to the time the train departs from the transport starting point.

The railway operator may also send information to the applicant that there is no alternative how to handle its application for capacity. The applicant may then re-submit its application in new dates and new conditions for designing train routes. The re-submission of this application shall be considered as a new application, including its date of receipt.

Upon acceptance of the route by the applicant, Správa železnic will allocate the railway capacity of this route. The proposed route is then processed and its data put into SPIS.

In the case of the ad hoc capacity application on lines with a closure of transport services (See Chapter 2.5.2) the applicant is required to apply for capacity at latest 3 business days prior to the scheduled movement if it requests adjusting the extent of the transport service closure, except in the case of applications due to a restriction of the runway operation, transport

services. The railway operator shall consider the possibility of adjusting the extent of transport service closure and shall inform the applicant accordingly.

4.5.3.4 Deadline for processing the application for ad hoc route capacity allocation

The capacity allocator shall respond to the applications for route capacity allocation in the shortest possible time but no later than within 5 working days from its delivery. Moreover, the capacity allocator will respond to the application for railway capacity allocation submitted in a period longer than 12 hours before the train departure from the starting transport/contact point of Správa železnic infrastructure no later than within the requested train departure from the starting transport/contact point of Správa železnic infrastructure.

It is also possible to reply by changing the status of the application in IS KADR

4.5.4 Coordination Process

If all applied requirements for allocating free route capacity to the annual timetable cannot be handled, Správa železnic shall coordinate due applications of the applicants and propose to all applicants, to the extent appropriate, another suitable route capacity, which may not correspond fully to the individual applications.

The Správa železnic always respects the already allocated track capacity allocated to the applicant by the corridor OSS on the lines included in the European Rail Network for Competitive Freight Transport (ERNCF) according to Regulation 913/2010 (see Chapter 1.7.1). The conditions and procedures for allocating C-OSS track capacity shall be published by the individual corridors in the Corridor Information Document (CID). More information on the websites of the individual corridors or on the website of the Správa železnic in the section dedicated to the ERNCF.

If it is not possible to handle all applied requirements for free railway capacity allocation, Správa železnic is entitled to preferentially allocate route capacity in the following order:

- 1) requirements for free railway capacity allocation for the purpose of operating rail transport on the basis of the contact on passenger transport public services,
 - i) supraregional or international trains,
 - ii) trains operated in the area of the region
 - iii) trains operated in the area of the municipality
- 2) requirements for the allocation of free railway capacity for the purpose of operating combined transport,
- 3) requirements for the allocation of free railway capacity for the purpose of operating international freight transport,
- 4) requirements for the allocation of free railway capacity for the purpose of operating regular international passenger transport,
- 5) requirements for the allocation of free railway capacity for the purpose of operating regular domestic passenger transport,
- 6) requirements for the allocation of free railway capacity for the purpose of operating regular domestic freight transport,
- 7) requirements for the allocation of free railway capacity for the purpose of operating other transport.

Priority allocation of Správa železnic railway capacity shall be discussed with the respective applicants; where appropriate, the procedure referred to in the first paragraph shall be applied adequately.

In the capacity allocation process for late applications to the annual timetable, applications for regular changes to the annual timetable and applications for ad hoc capacity allocation, conflicts during allocating capacity are handled in such a way that priority is given to the application received by Správa železnic earlier.

4.5.5 Dispute Resolution Process

If the applicant does not agree with the coordination of due applications, it shall disclose its disapproval together with the justification or a proposal of an alternative solution for the coordination of due applications, in writing within five days from the date of delivery of the proposal for capacity allocation to Správa železnic. Správa železnic shall resolve the disagreement no later than 10 working days from the date of receipt of the applicant's disapproval.

The applicant, whose application for railway capacity allocation was not satisfied by Správa železnic even after the completion of the coordination process, is entitled to request the Transport Infrastructure Access Authority (see Chapter 1.6), to review if the extent of the allocated capacity or the procedure for its allocation is not in contradiction to the Rail Act.

If the Transport Infrastructure Access Authority finds that the extent of the allocated capacity is in contradiction with the Rail Act, the allocator shall re-allocate railway capacity and determine the manner of this allocation.

4.6 Congested Infrastructure

In cases where, after coordination of the required routes and consultations with applicants, it will not be possible to satisfactorily satisfy requests for free track capacity while complying with quality parameters, the Správa železnic shall declare the relevant infrastructure element on which this situation occurred as "congested track" within the meaning of the Railways Act. The Správa železnic shall demonstrably notify this fact on the Railway Operation Portal to all applicants with whom it has a contract pursuant to Chapter 3.3.2 or 0.

The Správa železnic is entitled to restrict railway capacity allocation on those sections of the infrastructure that cannot satisfy the demand for railway capacity during certain time periods or after coordination of different applications for railway capacity, i.e. in the case of exhausted railway capacity.

Správa železnic is entitled to withdraw the allocated railway capacity on the track section where the capacity has been exhausted or in the section where restrictions for railway operation are planned if the allocated train routes in accordance with the time table are not used in this section for at least 75% during a period of one month. The above mentioned right to withdraw railway capacity allocation does not apply to cases where the railway capacity is not used due to reasons on the part of the railway operator.

If the respective infrastructure is declared by the railway operator to be the infrastructure with exhausted capacity, Správa železnic applies priority criteria for the coordination process stated in Chapter 4.5.4 when allocating this railway capacity.

4.7 Exceptional Transport and Dangerous Goods

4.7.1 Exceptional Transport

The RU is obliged to discuss with the railway operator any transport of an exceptional consignment in accordance with the internal regulation of the railway operator concerned by such transport.

The discussion of the conditions for exceptional transport must be completed with all railway operators concerned by the transport prior to its commencement.

The RU is obliged to enter the identification number and the number of the commanding dispatch for transport of the exceptional consignment into the information system of the railway operator in accordance with internal regulation of the concerned railway operator.

4.7.2 Dangerous Goods

When transporting dangerous goods, the RU is obliged to comply with the Rules for the International Carriage of Dangerous Goods (RID), as amended, and national generally applicable environmental legislation when commencing such transport or other internal regulations and documents of the railway operator.

The RU is allowed to transport dangerous goods in accordance with RID under the conditions specified therein. When transporting dangerous goods, the RU must ensure that the railway operator has at its disposal information in the following extent at minimum:

- train composition,
- position of the wagon with dangerous things on the train,
- UN numbers of transported dangerous goods,
- presence of dangerous goods packed in limited quantities according to Chapter 3.4 of the RID if only dangerous goods packed in limited quantities are transported and a classification of a wagon or large container is required pursuant to Chapter 3.4 of the RID,
- weight of transported dangerous goods.

The RU shall enter these data into the IS of the railway operator before the departure of the train from the departure station or from the point of marshalling the wagon with dangerous goods into a train.

Detachment of wagons with dangerous goods must be negotiated by the railway operator with the RU in advance. In particular, the following must be agreed and approved by the railway operator:

- location of detached wagons with dangerous goods (station, track)
- time period of detachment of wagons with dangerous goods,
- information on whether supervision over wagons with dangerous goods will be carried out and who will ensure it,
- information on where train documentation and transport documents will be stored.

Procedures in case of exceptional events (leaks, accidents etc.) are regulated by internal regulations and other documents of the railway operator. The RU is obliged to provide the railway operator at request with its own procedures respecting the principles set by the railway operator.

RUs and other legal or natural persons involved in the transport of high risk dangerous goods must accept and apply such safety measures to ensure safe handling and transport of dangerous goods, by stipulating responsibilities and rules for handling in the so-called Safety Plan. This Safety Plan will be drawn up by the RU in accordance with Správa železnic Safety Plan for Transport of High Risk Dangerous Goods pursuant to the RID (drawn up under 1.10.3.2 of the RID) and in compliance with internal emergency plans for marshalling yards of the railway operator. According to the RID, high risk dangerous goods are goods that might be potentially misused in terrorist attacks and that might have serious impacts such as massive fatalities or mass infection. An Overview of high risk dangerous goods is provided in Chapter 10 of the RID.

Any report of exceptional events must contain information on the presence of transported dangerous goods pursuant to RID.

Contacts to regional railway operators are listed in Chapter 1.6.

4.8 Rules After Path Allocation

4.8.1 Rules for Path Modification

These rules address the process by which the applicant is allocated track capacity and the train path that he needs to modify.

It is possible to modify a route with allocated capacity based on:

- Regular requests for allocation of track capacity to the annual timetable and late requests to the annual timetable
- Requests for ad hoc allocation of track capacity

It is not possible to edit a route if it has already been activated in the operational applications of the Správa železnic.

It is not possible to edit another applicant's route.

The applicant for the modification of the route is submitted by the applicant to the Správa železnic in the Czech language electronically, namely:

- via the IS KADR web form located on the Railway Operation Portal (<http://provoz.spravazeleznic.cz/KADR>), in accordance with the instructions issued by the railway operator for the operation of this IS;
- through electronic data exchange between the applicant's IS and the KADR IS, according to the conditions located on the Railway Operation Portal;
- for interstate applications also via IS RNE PCS. The railway operator will inform the applicant about the start of data communication between IS RNE PCS and IS KADR on the Railway Operation Portal.

The application must contain all the data defined in chapter 0.

The provisions of Chapter 4.5.3.2 shall apply mutatis mutandis to the acceptance of a request for a route modification.

The provisions of Chapter 4.5.3.3 apply mutatis mutandis to the acceptance of a route modification proposal .

The provisions of Chapter 4.5.3.4 shall apply mutatis mutandis to the date of processing the request for route modification.

The allocation of capacity for the request for route modification is performed by the Správa železnic via IS KADR and is charged. The price is given in chapter 5.3.

4.8.2 Rules for Path Alteration

These rules address the process by which the applicant has allocated track capacity and train path, which needs to be modified due to a change in the description of the infrastructure on the part of the Správa železnic.

It is possible to modify a route with allocated capacity based on:

- Regular requests for allocation of track capacity to the annual timetable and late requests to the annual timetable
- Requests for ad hoc allocation of track capacity

The request for a change of route is created in the KADR system without the cooperation of the applicant.

The provisions of Chapter 4.5.3.3 shall apply mutatis mutandis to the date of processing the request for a change of route.

The allocation of capacity for the request for route modification is performed by the Správa železnic via IS KADR and is free of charge. The capacity allocation product applies to him for other reasons on the part of the Správa železnic (**JD**).

4.8.3 Non-Usage Rules

From the point of view of the allocated train path, a track capacity is considered to be used on a specific day if it was used on at least two transport points on that day. This means that the applicant cannot claim the multiple use of one business case (TR ID) and one assigned data schedule (PA ID) for multiple trains for a specific day. The provisions of this paragraph do not affect the assessment of capacity utilization in relation to individual inter-station sections, as stated in Chapter 5.7.

By using the route on one inter-station section in one time period, the applicant loses the right to use the allocated route on other originally allocated sections.

The RU may use the allocated capacity only in such a way that at no point in the route does the deviation from the allocated time position exceed 3 hours before the allocated route (lead) or 20 hours after the allocated time position (delay). If the RU requests a higher deviation, it is obliged to submit a request for a new allocation of track capacity.

If the allocated railway capacity is lost to the applicant due to a train delay at the departure station of more than 1,200 minutes due to a reason on the part of the applicant, or the allocated railway capacity is not used, the applicant is obliged to pay a penalty to the capacity allocator.

If the applicant cannot use the allocated railway capacity for reasons on the part of the Správa železnic, the sanction according to the previous paragraph does not apply and the applicant has the right to use the offered alternative railway capacity (diversions). This spare track capacity is allocated free of charge.

If the applicant is unable to use the allocated track capacity along the entire length of the train path of the allocated track capacity for reasons on the part of the Správa železnic and does not exercise the right to free replacement of the track capacity, he may request a refund of the railway capacity allocation for days when the applicant could not use the track capacity. in full. In such a case, the Správa železnic is obliged to comply with the request.

4.8.4 Rules for Cancellation

If for any reason the applicant does not intend to use the allocated track capacity, or intends to limit the scope or frequency of train journeys on certain days or during a certain period, he is obliged to give up the allocated track capacity at the Správa železnic.

The surrender of track capacity is carried out:

- » »IS RNE PCS service on interstate routes or
- » »IS KADR service or data communication between the applicant's IS and IS KADR.

The thus released track capacity can then be allocated to another applicant.

If the applicant waives the allocated track capacity less than one month before the planned day of the journey outside the deadline for regular changes of the timetable due to a reason on the part of the applicant, the applicant is obliged to pay a penalty to the capacity allocator (see chapter 5.6.4).

If the applicant cannot use the allocated railway capacity for reasons on the part of the Správa železnic, the sanction according to the previous paragraph does not apply and the applicant has the right to use the offered alternative railway capacity (diversions). This spare track capacity is allocated free of charge.

If the applicant is unable to use the allocated track capacity along the entire length of the train path of the allocated track capacity for reasons on the part of the Správa železnic and does not exercise the right to free replacement of the track capacity, he may request a refund of the

railway capacity allocation for days when the applicant could not use the track capacity. in full. In such a case, the Správa železnic is obliged to comply with the request.

4.8.5 Rules for capacity withdrawal

The Správa železnic is entitled to withdraw the railway capacity allocated to the applicant in the event that:

- a) has not been used for a period of one month;
- b) the conditions set out in the Network Statement are met for this purpose;
- c) the RU has ceased to meet the conditions for access to the railway specified in Chapter 3.2.2 of this Network Statement;
- d) the applicant has not paid the invoiced price for the allocation of track capacity or the price for using the track by train or the price for services provided or the penalty for unused or waived allocated capacity within the contractual due date and within the replacement period specified in the written reminder track capacity and removal of already allocated track capacity;
- e) the RU uses the runway in contravention of the allocated runway capacity;
- f) for the route, the runway capacity on the adjacent infrastructure has been renounced / withdrawn;
- g) it is provided for by law;
- h) it has been decided by a final decision of a public authority.

The Správa železnic is also entitled to limit the railway capacity allocated to the applicant if the allocated railway capacity has been used for less than 25% of the allocated train kilometers for a period of one month. Reasons on the part of the applicant shall be considered to be all reasons which are not on the side of the capacity allocator, the railway operator, the state administration and self-government and which are not caused by an extraordinary event or force majeure.

The Správa železnic is also entitled to require the applicant to limit the scope or frequency of train journeys on certain days or during a certain period, ie to waive track capacity which has been used for less than 50% of allocated train kilometers for a period of one month, unless due to reasons which the applicant could not influence.

4.9 Timetabling and Capacity Redesign (TTR)

4.9.1 Objectives of TTR

RailNetEurope (RNE) and Forum Train Europe (FTE), supported by the European Rail Freight Association (ERFA) are working on a project called TTR to harmonise and improve the timetabling system to increase the competitiveness of rail.

It consists of an improved planning of the distribution of capacity (including temporary capacity restrictions) and a capacity allocation process.

The purpose is to better serve market needs and achieve an optimised use of existing capacity. For passenger traffic it will mean earlier availability of the final timetable allowing earlier and more reliable ticket purchasing for passengers. For freight traffic, it will mean more possibilities for path request options closer to the first day of operation and thus more flexibility.

4.9.2 Process Components

The TTR process is built around the following components:

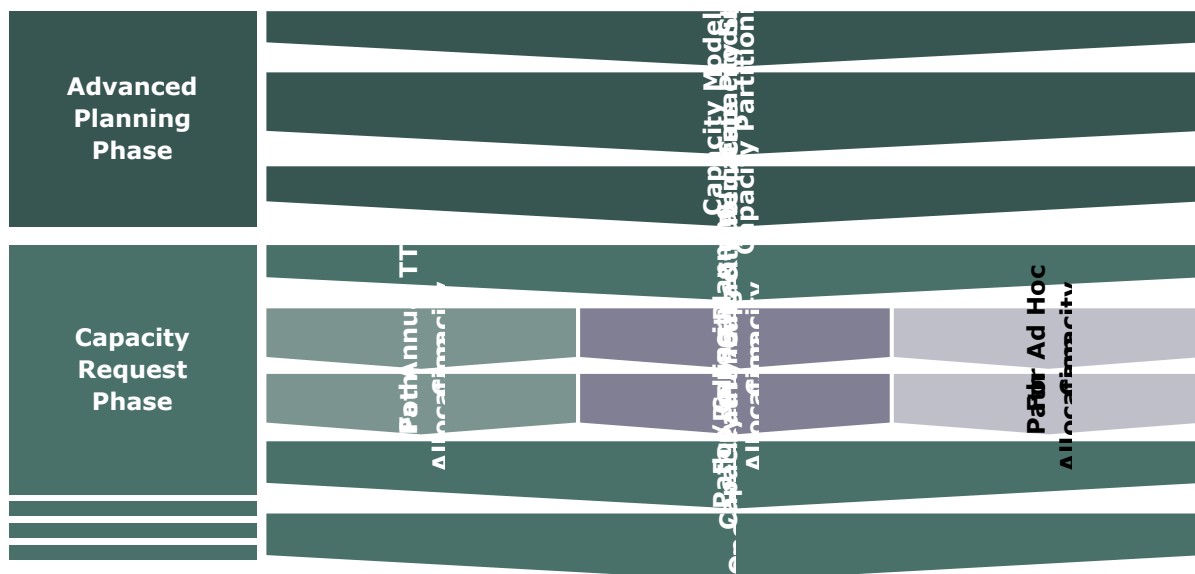

The essential components are described in further detail below.

- **Capacity Strategy** (X*-60 to X*-36 months) The capacity strategy is the long-term capacity planning of the IM for a dedicated line, a part of a network or entire network. The major aim of the capacity strategy is to provide a first overview of available capacity on the infrastructure in the future and of future capacity needs. It enables the IM to share future capacity needs with neighbouring IMs and applicants and agree on the main principles to be used for the capacity model construction.
- **Capacity Model** (X*-36 to X*-18 months) with Capacity Partitioning: The capacity model gives a more detailed definition of the demand forecast, and allows the partitioning of capacity into Annual Planning, Rolling Planning, and Temporary Capacity Restrictions and unplanned capacity (where available). Applicants have the possibility to give input into the capacity model by announcing their capacity needs and can provide their reaction on the proposed capacity partitioning. The capacity needs announcements and the capacity model are described respectively in chapters 4.9.3.1 and 4.9.3.2.
- **International alignment on TCRs:** Temporary Capacity Restrictions (TCR) may occur in case of maintenance, renewal, or building of the infrastructure or other restrictions of use, which have an impact on the available capacity on a line. They refer to TCRs with major, high, medium and minor impact as well as to possessions (unavailability of paths due to e.g. maintenance). TCRs are necessary to keep the infrastructure and its equipment in good condition and to allow infrastructure development in accordance with market needs (see chapter 4.3 for more information).
- **Path/Capacity Requests:**
 - o **Capacity for Annual requests:** Capacity to be coordinated at a defined deadline or made available for requests placed after this deadline.
 - o **Capacity for Rolling Planning requests:** Dedicated capacity based on capacity bands for a defined time window or path, with specific requesting deadlines.
 - o **Capacity for ad hoc requests:** Unplanned capacity or residual capacity for requests submitted after X-2.
 - o **Capacity for short-term ad hoc requests:** Unplanned capacity or residual capacity for requests submitted less than 30 days before operation.

*X stands for the day of timetable change 2025

4.9.3 Implementation

Správa železnic participates in the project implementation at national level according to the common timeline as described in the following graph. The TTR approach, especially the

innovative process components are tested in pilots (see chapter 4.9.4) with the goal of evaluating the system and providing possible adjustments or improvements to the project prior to national TTR process implementation (for more information see chapter 4.9.4).

As a first step of the national process implementation, Správa železnic elaborated the capacity model during timetable 2022.

For more information, please contact the TTR national implementation manager of Správa železnic (see chapter 1.6).

4.9.3.1 Capacity Needs Announcements

Applicants may notify the Správa železnic of their capacity needs for the 2026 timetable between 36 and 18 months before the 2026 timetable through the national manager.

In order to properly process the capacity model, it is necessary to provide at least the following information about the required concept:

- estimated train paths;
- estimated departure and arrival times of trains;
- cycle period;
- train stopping points and expected actions at stations;
- data on deployed vehicles needed to determine driving dynamics;
- intended connection ties in nodes.

In the event that the Správa železnic finds from the notification that capacity needs overlap, it shall contact the applicants concerned in order to find a solution. The Railway Authority will use the information provided as input to the capacity model (for more information on the capacity model, see chapter 4.9.3.2). He preliminary capacity claims thus notified are not considered by the Správa železnic to be a binding request for a train path.

4.9.3.2 Capacity Model

The capacity model is based on Správa železnic's capacity strategy (see chapter 4.9.2), market requirements (e.g. new service plans) and TCRs (Temporary Capacity Restrictions, see chapter 4.9.2.3) and serves as the baseline for all capacity requests. To fulfil this purpose, it assigns the capacity to the various commercial and technical needs ('capacity partitioning'), which generally are:

- Capacity required for TCRs;
- Capacity for commercial traffic.

After the evaluation of capacity already consumed by TCR, the available commercial capacity is split between:

- Capacity available for Annual TT requests (see chapter 4.9.2);
- Capacity safeguarded for Rolling Planning requests (see chapter 4.9.2);
- Unplanned capacity.

Sentence may be included if the IM does the splitting only at a later stage:

The exact splitting of each mode of traffic might also be done at a later stage, at the latest at publication of the corresponding capacity.

4.9.3.3 Capacity Supply

On the basis of the capacity partitioning, at approx. X-18, Správa železnic will work on defining a capacity supply by combining pre-planned paths, system paths, Rolling Planning capacity bandwidths and taking into account Rolling Planning multiannual capacity commitments, and allocated framework agreement requests from previous years according to its practice, to cover the many different commercial needs. The capacity supply can also encompass unplanned capacity.

In the case of cross-border lines, these activities will be harmonised with the neighbouring IM(s).

In order to allow applicants to plan and harmonise their requests, Správa železnic will publish the capacity supply for Annual Timetable and Rolling Planning demand (in terms of bandwidths/slots/catalogue paths) at the latest by X-11.

Applicants will receive a proposal for consultation capacity before final publication.

4.9.4 TTR Pilot Project

Existing process components have been streamlined and improved, and some innovative process components and products newly created to fully cover all market requirements.

In order to test the new process, especially the innovative process components, across Europe, pilot projects across several European countries have been operational since timetable 2019-2020. The purpose is to assess how the new TTR process effectively responds to the relevant objectives. It should also provide a possibility to adjust any critical aspects and make further adjustments before the actual implementation of the project and demonstrate first benefits for the market.

In particular, the pilots are enabling a first application of the capacity model and are testing the benefits for the market of the Rolling Planning requests.

The pilot lines along four Rail Freight Corridors where the new system is tested are:

- Basel – Mannheim - Aachen (on RFC Atlantic)
- Amsterdam – Paris (on RFC North Sea – Mediterranean)
- Mannheim – Northern Italy (on RFC Rhine-Alpine)
- Břeclav – Tarvisio-B./Jesenice/Spielfeld (on RFC Baltic-Adriatic except for the line Villach-Jesenice, which is not part of RFC Baltic-Adriatic)

4.10 Principles of capacity allocation on railway freight corridors

In accordance with the judgment of the Court of Justice of the European Union (Fifth Chamber) of 24 June 2021 DB Netz AG v Bundesrepublik Deutschland case C-12/20, all 11 rail freight corridors (see chapter 1.7.1) have agreed on uniform conditions and procedures for the allocation of track capacity on rail freight corridors through corridor OSS (C-OSS). These conditions are published in the Corridor information documents of individual railway freight corridors and in Annex "R" of this Network Statement.

5 Services and charges

5.1 Introduction

RUs are provided with services in accordance with applicable legislation. According to the level of access and services provided, these services can be divided into four basic groups:

- 1) Minimum access package,
- 2) Service provided on service facilities,
- 3) Additional services,
- 4) Ancillary services.

5.2 Charging Principles

Allocation body and railway operators charge applicants the following prices for the use of the railway infrastructure of national and regional railways owned by the Czech Republic:

- a. the prices of the allocator and the operator for the use of the railway infrastructure within the scope of the Annex to Decree No. 76/2017 Coll.,
- b. prices of the operator for access by rail to service facilities,
- c. the operator's prices for the use of service facilities for purposes directly related to the operation of rail transport,
- d. prices for other services provided under this Network statement.

The prices listed under letters a) to c) are prices for regulated services in the sense of the valid decree of the Ministry of Finance published in the Price Bulletin (List of goods to which materially regulated prices apply, item 3. Use of railway infrastructure of national and regional railways and publicly accessible sidings) and item 5. Use of service facilities for purposes directly related to the operation of rail transport). They are valid for the duration of the timetable and are published in the path declaration. Prices for regulated services shall be equivalent and non-discriminatory to all applicants who are provided with services of the same type on the same or similar parts of the railway infrastructure. Price regulation applies to national and regional railways according to § 3, paragraph 1 letter a) and b) of the Railways Act. The prices listed under letter d) are not prices for regulated services and are not subject to material regulation according to the Ministry of Finance's assessment.

5.3 Minimum Access Package and Charges

Within the minimum access package, the RU has the right to process the RU's request for allocation of track capacity, elaboration of a timetable according to the allocated capacity and enabling the use of the allocated track capacity according to the agreed timetable. Furthermore, on the basis of a contract for the operation of rail transport, it has access to services related to the use of the track and the operation of a rail vehicle to the extent of:

- 1) use of the track within the scope of the annex to Decree 76/2017 Coll., including the use of equipment for the supply of traction current, if available,
- 2) organization of rail transport, provision of train running and shunting by rail vehicle, operational management of rail transport, radio connection with rail vehicle, if available, reporting and provision of information to the RU about the train running of the given RU;
- 3) the provision of other information necessary for the establishment or provision of transport services for which railway capacity has been allocated.

The price for the minimum access package consists of:

- a) a) the allocator's prices for the allocation of railway capacity,
- b) b) prices of the railway operator for the use of the railway by train running,
- c) c) prices of the railway operator for access by rail to service facilities.

The price for allocating railway capacity depends on the system used to manage the request and on the number of required framework routes. Price calculation for allocating railway capacity takes into account the costs of operating Správa železnic electronic information systems and other professional activities necessary to incorporate framework routes into the train timetable.

The price for allocating railway capacity is set depending on:

- length of the time interval between the submission of the application for railway capacity allocation and the required date of its usage,
- relation between the submitted application for railway capacity allocation and the date of the design of the annual timetable or its planned changes,
- processing complexity of the application.

The price for railway capacity allocation includes:

- charge for process of railway capacity allocation,

- charge for processing the train timetable (excluding printing costs and costs for utility distribution) assigned to the respective application of the applicant,
- charge for the operational implementation of the train and surcharge for short-term discussion and handling of the application.

Price for railway capacity allocation is calculated according to the following formula:

$$\text{Price} = K_1 + K_2 \times \text{Route length} + K_3 \times \text{Number of movement days [CZK]}$$

where:

K₁ rate for processing and planning of the timetable and allocating railway capacity [CZK]

K₂ rate for designing a train route [CZK/km]

K₃ rate per day for train route allocation [CZK/day]

Route length distance of the allocated route between the departure and final points of the route on railway network where Správa železnic is the railway operator or capacity allocator [km]

Number of movement days number of days for which the route is allocated [day]

Ceny Správy železnic jako přidělece **za přidělení kapacity dráhy** jsou uvedeny v následující tabulce.

Price for Railway Capacity Allocation

	Product	K ₁	K ₂	K ₃
RJ	application for railway capacity allocation to the annual timetable	1700,00	8,00	10,00
PJ	late application for railway capacity allocation to the annual timetable	1700,00	10,00	20,00
DO	application for long-term ad hoc railway capacity allocation for 20 days or more – passenger train	1700,00	10,00,	20,00
DN	application for long-term ad hoc railway capacity allocation for 20 days or more – freight train	1100,00	0,00	25,00
N3	application for ad hoc railway capacity allocation for "more than 3 days"	100,00	0,00	70,00
P3	application for ad hoc railway capacity allocation for "less than 3 days"	100,00	0,00	160,00
TB	application for ad hoc railway capacity allocation for technical and safety tests of rail vehicles	480,00	0,00	70,00
ZK	application for ad hoc railway capacity allocation for test trives of non-approved type vehicles or driving above the line speed	960,00	0,00	70,00

Price for the allocation of railway capacity for reasons on the part of the Správa železnic

Produkt	Popis	K ₁	K ₂	K ₃
RD	regular request for allocation track capacity to the annual timetable due to a reason on IM side	0,00	0,00	10,00
PD	late request for allocation railway capacity to the annual timetable due to reason on IM side	0,00	0,00	20,00
UI	application for ad hoc railway capacity allocation for train movements for the purpose of Správa železnic infrastructure maintenance	0,00	0,00	0,00
OM	application for ad hoc railway capacity allocation due to temporary capacity restrictions	0,00	0,00	0,00
JD	Other reasons on IM side	0,00	0,00	0,00

Prices for the Use of Railway for the Purpose of Train Movement and conditions for their application are listed in Annex "C" to this Network Statement.

Prices for the rail operator to access a path to service facilities Správa železnic currently does not calculate and charge. Information on prices of this type calculated and

charged on railways, where the Správa železnic is the allocator, by other operators, is published by the Správa železnic in this Network Statement only to the extent provided by the data provided by the relevant railway operator.

5.4 Additional Services and Charges

In the event that the operator of a service facility provides any of the following services as ancillary services, it shall provide them on a non-discriminatory basis upon request to each RU:

- 1) supply of traction electricity,
- 2) preheating of a railway vehicle intended for the transport of persons,
- 3) services related to the transport of dangerous goods or to the operation of a railway vehicle having special operational and technical characteristics.

The amount of prices for additional services on railways, where the Správa železnic is the allocation body provided by other providers, is published by the Správa železnic only to the extent of data communicated by the service provider.

5.4.1 Supply of traction electricity

Správa železnic is the traction power supplier for RUs using traction on all electrified railways it operates. Each RU must conclude a written Contract for the supply of traction electric power with Správa železnic prior to the commencement of its collection.

Contact to the provider of traction electric power:

Company:	Správa železnic, státní organizace, Centrum sdílených služeb
Registered office:	Riegrovo nám. 914, 500 02 Hradec Králové
ID No.:	70994234
Tax ID No.:	CZ70994234
Legal form:	státní organizace
Web:	www.spravazeleznic.cz

Detailed conditions for the provision of additional service, including billing and invoicing the supply of traction electric power to individual RUs, which are binding on Správa železnic and the RUs, are subject to a separate Contract for the supply of traction electric power between Správa železnic and a respective RU. A specimen contract including the terms of providing service for the supply of traction electric energy and the price for providing this service is available at www.spravazeleznic.cz in the section Energy. Prior to the conclusion of the Contract for the supply of traction electric energy, the RU is obliged to conclude a contract for the operation of railway transport with Správa železnic (see Chapter 3.3.2.1).

5.4.2 Preheating of a railway vehicle intended for the transport of persons

The Správa železnic provides a service for the preheating of railway vehicles intended for the transport of persons on the electric preheating facilities operated by it. Details the Správa železnic publishes in the description of service facilities Other technical equipment for the operation of rail transport - Electric preheating equipment and socket stands, which is published on the railway operation portal (<https://provoz.spravazeleznic.cz>).

5.4.3 Services related to the transport of dangerous goods or to the operation of a railway vehicle having special operational and technical characteristics

The Správa železnic ensures the handling of extraordinary consignments on the network operated by the Správa železnic, see also chapter 3.4.3.

Prices for services related to handling exceptional consignments on railways operated by Správa železnic are set depending on the category of the exceptional consignment. The price is given for one handling of the shipment - for one loading place in the Czech Republic. In the case of international transport, the border crossing station, including the border section of the route from the state border, is considered the loading place. The categories of exceptional consignments are set out in the following table:

The category of exceptional consignments

Price category	The category includes exceptional consignments
Category 1	<ul style="list-style-type: none"> Weight of load exceeds the specified track load class or the vehicle's maximum load (loading gauge grid / wagon additional data grid). Solid load units loaded on two or more wagons with pivots. Flexible load units of more than 36m in length on multiple wagons¹). Consignments loaded on wagons with more than 8 axles. A vehicle for which the Rail Authority has decided that it may be operated or transported under special technical and operating conditions. A vehicle loaded or on its own wheels without the RIV/RIC/TEN designation or without the CZ marking in the loading capacity grid. Other consignments resulting from European standards, Agreements and Conventions.
Category 2	<ul style="list-style-type: none"> Load exceeding loading gauge (hereinafter "ELG"). A vehicle exceeding by its kinematic or static profile the respective track clearance profile.
Category 3	<ul style="list-style-type: none"> ELG consignment and, concurrently, the weight of its load exceed the specified track load class or loading gauge grid / wagon additional data grid. A vehicle exceeding by its kinematic or static profile the respective track clearance profile and, concurrently, exceeding specified track load class, loading gauge grid / wagon additional data grid or loading capacity of the vehicle.
Category 4	<ul style="list-style-type: none"> ELG consignment loaded into RS on a special low-loader wagon with lift and release handling.
Category 5	<ul style="list-style-type: none"> ELG consignment loaded into RS on a special low-loader wagon with lift and release handling.

Explanation: "RS" means registration space in which the operator records structures, facilities and natural objects (general objects). On operators' lines there is a RS of 2.2 with a half width of 2,200mm and RS of 2.5 with a half width of 2,500mm. The value of the critical point of the consignment (18b) and the required route is critical for the assessment of category 4 or 5.

For repeated transports of typed extraordinary consignments with PLM (category 2 extraordinary consignments - see the table above), the Správa železnic offers RUs the issue of a Přepravní typový list (hereinafter also "PTL") with a discussion of specific tracks at the loading point or at the unloading point. Such PTL can be issued under the following conditions:

- The RU requests the issuance of a PTL at least 45 days before the first journey,
- PTL is valid for the period of one timetable,
- Shipments with PLM or vehicles whose kinematic or static outline exceed the relevant cross-section of the track can only be carried out between transport points and along the routes specified in the PTL,
- PTL applies to all RUs,
- In view of the need to maintain a unique identification of an extraordinary shipment, it is possible to issue only one PTL during one timetable for one typed shipment with a PLM or a vehicle crossing the relevant cross-section of the track with its kinematic or static contour, and it is not possible to change the issued PTL,
- PTL can only be issued to shipments with PLM or vehicles whose kinematic or static contour exceeds the relevant cross-section of the track, which meet the critical points listed in the following table, in view of the difficulty of checking the spatial patency of the track:

Critical points for shipments discussed within the PTL in accordance with regulation SŽDC D31

x	12a	12b	13s	13v	14	15
A	1555	1555	1075	1200	4760	650
B	1565	1565	*	1340	0	1530
C	1495	1495	*	3170	0	1530
D	1145	1145	*	4300	0	1530
E	1570	1570	*	1340	3950	0
F	1500	1500	*	3170	3950	0

G | 1150 | 1150 | * | 4300 | 3950 | 0
 Note: Connect points B-C-D and E-F-G directly.

The prices for services related to the handling of extraordinary shipments are listed in the following table:

Prices for services related to negotiating exceptional consignments

Product	Category 1	Category 2	Category 3	Category 4	Category 5
Negotiation of the PTL with assessment of specific loading and unloading points		3 000,- Kč ³⁾			
Negotiation of transport and setting transport conditions for exceptional consignments	1 000,- Kč	3 000,- Kč	5 000,- Kč	13 000,- Kč	Individuální ²⁾
Transport survey of the route of an exceptional consignment	500,- Kč	1 500,- Kč	2 500,- Kč	7 500,- Kč	Individuální ²⁾
Issuing Edps „Order for transporting an exceptional consignment“ – the price is shown for one Order (dps number)	50,- Kč	50,- Kč	50,- Kč	50,- Kč	50,- Kč

Notes:

¹⁾ By operators and some other railway undertakings, transports operated on unit trains are considered to be regular consignments (without negotiating as an exceptional consignment) provided that the cargo security conditions are complied with in accordance with international regulations (e.g. UIC - Loading Directive).

²⁾ The individual price per business case; the price will be set by a commercial offer against the demand received, but at least in the amount of the price category 4

³⁾ The price is given for one assessed loading or unloading point

5.5 Ancillary Services and Charges

The following ancillary services may be provided on railways where the Správa železnic is the allocator:

- » Provision of information related to the operation of rail transport,
- » Access to telecommunication networks,
- » Provision of audiovisual services to passengers,
- » Issuing a timetable.

5.5.1 Provision of information related to the operation of rail transport

Správa železnic, as the railway operator, allows RUs to access the IS Správa železnic providing information on train movements and other information related to the operation of railway and rail transport. Access conditions for individual ISs are provided by department Správa železnic at request.

At the Milotice nad Opavou – Vrbno pod Pradědem regional railway, the railway operator, t PKP CARGO INTERNATIONAL a.s. provides additional information related to the organisation of railway transport and railway transport safety, especially on technological procedures used in the operation of rail transport and the extent and level of provided services. More information is provided directly by the operator of this railway. Contact information are listed in Chapter 1.6.

5.5.2 Access to telecommunication networks

Správa železnic operates non-public fixed and radio (digital or analogue) telecommunication networks (TN) enabling voice and data communication. Access conditions for individual TN are provided by Správa železnic at request.

5.5.3 Providing Audio-visual Information to Passengers

Správa železnic offers a service of providing audio-visual information to passengers. Conditions for using this service are published by Správa železnic on the Infrastructure Operation Portal. In the case of services provided by other providers on railways where Správa železnic is the capacity allocator, Správa železnic publishes data on the Infrastructure Operation Portal only to the extent provided by the service provider.

5.5.4 Issue of the Timetable

Správa železnic offers the following services to RUs and other operators:

- publication of a timetable on lines where Správa železnic is not the operator, contractual transport conditions and the tariff of the RU in the timetable, incl. data transmission to CIS,
- publication of a timetable for the RU's train in the required operating control point, above and beyond the obligations of the railway operator, as set in Decree No. 173/1995 Coll.
- processing and publication of additional RU data related to the IDS information to which the RU is involved, including the publication of possible connecting bus services and tariff conditions in the following extent:
 - "esko" and any possible mutations ("erko", "účko"),
 - information on the connecting bus transport, either within the IDS or outside, using the bus sign after the name of the station,
 - plans of IDS lines and zones,
- planning and processing of the timetable for a track section (sidings) not operated by Správa železnic and connected to a railway operated by Správa železnic.

In the case of services provided by other providers on railways where Správa železnic is the capacity allocator, Správa železnic publishes data on the Infrastructure Operation Portal only to the extent provided by the service provider.

The price for services associated with issuing timetables is set for each product as follows:

The price for services associated with issuing timetables

Product	Price
publication of a timetable on lines where Správa železnic is not the operator, contractual conditions of transport and the tariff of the RU in the timetable, incl. data transmission to CIS,	CZK 10,000 / each A5 format page
publication of a timetable for the RU's train in the required operating control point, above and beyond the obligations of the operator, as set in Decree No. 173/1995 Coll.	CZK 238 / operating control point
The price for processing and publishing additional RU data related to the IDS information in which the RU is involved, including the publication of connecting bus services and tariff conditions	CZK 5,000 / route

The price for designing and processing of the timetable for track section (sidings) not operated by Správa železnic and following the route operated by Správa železnic is determined as follows:

The price for designing and processing of the timetable for track section (sidings) not operated by Správa železnic

Product	Price
Processing of a new timetable	CZK 300 / route
Processing of regular change of timetable	CZK 500 / route

5.6 Financial Penalties and Incentives

5.6.1 Penalties for Path Modification

The Správa železnic does not apply any sanction for path modification.

5.6.2 Penalties for Path Alteration

The Správa železnic does not apply any sanction for path alternation.

5.6.3 Penalties for Non-usage

If the RU does not use the allocated track capacity (see Chapter 4.8.3), or the allocated track capacity is forfeited due to a train delay of more than 1,200 minutes, due to the RU, the RU is obliged for each scheduled day of running when this situation occurs, pay the capacity allocator a penalty for unused allocated capacity, calculated according to the length of the unused allocated route, rate and conditions set out in Annex "C" Part D of this Network statement. The capacity allocator shall apply this sanction only on the selected network. Only those unused parts of the allocated route that are located on the selected network are subject to a sanction. The selected network on which the capacity allocator applies a sanction for unused allocated capacity is shown on map M14.

Reasons on the part of the RU shall be considered to be all reasons which are not on the side of the capacity allocator, the railway operator, the state administration and self-government and which are not caused by an extraordinary event or force majeure.

5.6.4 Penalties for Path Cancellation

Pokud If the applicant waives the allocated track capacity less than 30 days before the scheduled day of the trip, outside the date of the regular change of the timetable due to a reason on the part of the applicant (see chapter 4.8.4, the applicant is obliged for each scheduled day of the trip to pay the capacity allocator a penalty for the renounced allocated capacity, which shall be calculated according to the length of the renounced allocated route, the rate and the conditions specified in Annex "C" Part D of this Network statement. The capacity allocator shall apply this sanction only on the selected network. Only those waived parts of the allocated route that are on the selected network are subject to a sanction. The selected network on which the capacity allocator applies a waiver for the renounced allocated capacity is shown on map M14.

Reasons on the part of the applicant shall be considered to be all reasons which are not on the side of the capacity allocator, the railway operator, the state administration and self-government and which are not caused by an extraordinary event or force majeure.

5.6.5 Incentives / Discounts

5.6.5.1 Incentives for framework agreements

Správa železnic does not provide any special incentives for framework contracts (see Chapter 3.3.1).

5.6.5.2 Incentives for vehicles using ERTMS

As part of the support for the development of ERTMS, the Správa železnic applies a discount when calculating the price for the use of the track by the train for rolling stock equipped with the mobile part of the ETCS system, which has activated encryption keys on the RBC side. Details are given in Annex "C" of Part C, paragraph III.5.

5.7 Performance Scheme

5.7.1 General principles and objectives

5.7.1.1 PDV Railway

PDV RAILWAY a.s. as the operator of regional railways Sokolov – Kraslice st. hr. and Trutnov hl. n. – Svoboda nad Úpou, in accordance with applicable legislation, monitors and evaluates in cooperation with RUs the causes of disruptions to the operation of rail transport. The purpose of the system is to motivate the RU and the railway operator to minimize defects during the operation of railway transport on the relevant railway.

5.7.1.2 PKP CARGO INTERNATIONAL

PKP CARGO INTERNATIONAL, a.s. as the operator of the regional railway Milotice nad Opavou – Vrbno pod Pradědem, in accordance with the applicable legislation, monitors and evaluates in cooperation with RUs the causes of disruptions to the operation of rail transport. The purpose of the system is to motivate the RU and the railway operator to minimize defects during the operation of railway transport on the relevant railway.

5.7.1.3 Správa železnic

Správa železnic in accordance with the Railways Act and Decree No. 76/2017 Coll. monitors and evaluates, in cooperation with RUs, the specific causes of disruption to the operation of rail transport. The ISOŘ information system (hereinafter referred to as the "ISOŘ IS") is intended to monitor and agree on the causes of disruption of rail transport operations between the Správa železnic and the RU.

Based on the RU's request, Správa železnic will also enable data communication of the module for agreeing the causes of disruption of rail transport operation with the RU's information system. The data communication will follow the procedures set out in the TAF / TAP TSI (DelayCauseMessage).

5.7.2 Performance monitoring

5.7.2.1 PDV Railway

The decisive factor is always the contract between the railway operator and the RU, which is in accordance with the applicable legislation.

Sanctions are not applied for train delays caused by the neighboring manager's infrastructure.

5.7.2.2 PKP CARGO INTERNATIONAL

The decisive factor is always the contract between the railway operator and the RU, which is in accordance with the applicable legislation.

Sanctions are not applied for train delays caused by the neighboring manager's infrastructure.

5.7.2.3 Správa železnic

The sanction regime includes:

- passenger trains other than group trains (Sv), which reach the last transport point on the Správa železnic network, are delayed by more than 15 minutes. If the train is run on a part of the route that is a group (Sv) and on a part with passenger transport, only parts of the route with passenger transport are included in the sanction system.
- express freight trains (Nex) and continuous freight trains (Pn), which reach the last transport point on the Správa železnic's network, are delayed by more than 240 minutes. If these trains are run as Nex or Pn only in part of the route, only this part of the route is included in the sanction system.

The sanction regime does not include:

- trains with a lead, ie trains that reach the last transport point on the network of the Správa železnic with a lead,
- trains for which track capacity was requested within a period of less than three working days (including the day of submission of the request) before the first requested day of train departure and which used the capacity allocated without solving of conflicts,
- service trains
- canceled trains.

The division of train types in the internal regulation of the railway operator SŽ D1 is decisive for determining the type of train.

Sanctions for delays caused on the network of a neighboring infrastructure manager shall not apply.

Performance monitoring is solved by coding the causes of delays by the operational employees of the Správa železnic, which takes place in the relevant SPIS applications with subsequent output to the IS ISOŘ. The cause must be determined by any disruption to the operation of rail transport from the 1 minute increment of train delay.

Each increment of a train delay is assigned to the responsibility of the Správa železnic, the RU or other causes based on the reason code of the delay. The codes are defined in Appendix 2 of the SŽ regulation D7, which is in accordance with Decree No. 76/2017 Coll., § 4. The list of codes and their description is given in Appendix "L" of this statement. Information on the increase in delay of each train and its causes are transmitted online to the RU for approval.

The operator shall make the assigned delay liability codes for each case available to the RU first

- a. three hours after passing through the given point - in case of assignment of the RU's liability code;
- b. after 24 hours after passing through the given point - in case of assignment of the responsibility code Operator or Others.

5.7.3 Financial model

5.7.3.1 PDV Railway

The railway operator and the RU are obliged to discuss each applied sanction with each other in advance, by the end of the following calendar month after the relevant calendar month in which the reason for applying the sanction arose.

If the disruption of rail transport operation corresponds to the cause according to § 4 paragraph (1) of Decree No. 76/2017 Coll., On the content and scope of services provided by the RU, and the causal delay of the RU's train exceeding 10 minutes is the operator obliged to pay the RU a penalty of CZK 200 for each such delayed train of the RU on a given track and a penalty of CZK 1,000 for the delay of all trains of the RU in a given month on a given track, if the sum of train delays in a given month exceeds by more than 10 minutes, 900 min. Trains of the RU, which cannot be realized within the period of the discussed exclusion (planned or extraordinary) with the RU within the approved plan of restriction of operation of the railway or its part according to 23c paragraph (1) of Act No. 266/1994 Coll., On railways, are not considered for trains delayed in the sense of the above and therefore they cannot be sanctioned for disrupting the operation of rail transport.

However, the railway operator is not responsible for the disruption of the operation of rail transport caused by a defect on the part of another railway operator pursuant to § 4 para. (1) let. d) of Decree No. 76/2017 Coll., on the content and scope of services provided by RUs and it is therefore not possible to apply a sanction for delayed trains for disruption of rail transport operations.

If the disruption of rail transport operation corresponds to the cause according to § 4 paragraph (2) of Decree No. 76/2017 Coll., On the content and scope of services provided by the RU, and the causal delay of the relevant train of any RU exceeding 10 minutes is the RU obliged to pay a penalty to the railway operator in the amount of CZK 200 for each such delayed train of any RU and a penalty of CZK 1,000 for the delay of trains of each RU on a given track in a given month, if the sum of delays of all trains of a given RU in a given month exceeds by more than 10 minutes, 900 min. However, the RU is not responsible for the disruption of the operation of rail transport caused by a defect on the part of another RU according to § 4 paragraph (2) letter c) of Decree No. 76/2017 Coll., on the content and scope

of services provided by RUs and it is therefore not possible to apply a sanction for delayed trains for disruption of rail transport operations.

However, neither the operator nor the RU is responsible for the delay caused by the cause according to § 4 paragraph (3) of Decree No. 76/2017 Coll., On the content and scope of services provided to the RU. These causes are not subject to the application of the sanction for disruption of rail transport operations.

5.7.3.2 PKP CARGO INTERNATIONAL

If the disruption of rail transport operation corresponds to the cause according to § 4 paragraph (1) of Decree No. 76/2017 Coll., On the content and scope of services provided by the RU, and the causal delay of the RU's train exceeding 90 minutes is the operator obliged to pay the RU a penalty of CZK 200 for each such delayed train of the RU on a given track and a penalty of CZK 1,000 for the delay of all trains of the RU in a given month on a given track, if the sum of train delays in a given month exceeds by more than 90 minutes, 900 min. Trains of the RU, which cannot be realized within the period of the discussed exclusion (planned or extraordinary) with the RU within the approved plan of restriction of operation of the railway or its part according to 23c paragraph (1) of Act No. 266/1994 Coll., On railways, are not considered for trains delayed in the sense of the above and therefore they cannot be sanctioned for disrupting the operation of rail transport. However, the railway operator is not responsible for the disruption of the operation of rail transport caused by a defect on the part of another railway operator pursuant to § 4 para. (1) let. d) of Decree No. 76/2017 Coll., on the content and scope of services provided by RUs and it is therefore not possible to apply a sanction for delayed trains for disruption of rail transport operations.

If the disruption of rail transport operation corresponds to the cause according to § 4 paragraph (2) of Decree No. 76/2017 Coll., On the content and scope of services provided by the RU, and the causal delay of the relevant train of any RU exceeding 90 minutes is the RU obliged to pay a penalty to the railway operator in the amount of CZK 200 for each such delayed train of any RU and a penalty of CZK 1,000 for the delay of trains of each RU on a given track in a given month, if the sum of delays of all trains of a given RU in a given month exceeds by more than 90 minutes, 900 min.

However, neither the operator nor the RU is responsible for the delay caused by the cause according to § 4 paragraph (3) of Decree No. 76/2017 Coll., On the content and scope of services provided to the RU. These causes are not subject to the application of the sanction for disruption of rail transport operations.

5.7.3.3 Správa železnic

The evaluation and calculation of the disruption of the rail transport operation takes place in two phases.

1. Evaluating the RU's Individual Movements, Calculating the Amount of the Penalty:

- a. Each train of a given RU included in the penalty regime is evaluated separately.
- b. For each train, increments of delays incurred during the train movement from Správa železnic's liability and increments of delays incurred during the train movement from the RU's liability are counted separately. The increments of delays generated during the train movement from other causes are not taken into account.
- c. The amount of the penalty shall be calculated as the rate of delay per minute multiplied by the positive difference between the sum of the increments of delay caused by one party and the sum of the increments of delay from the other party, the parties being the Správa železnic and the RU. The amount of the sanction is different for the RU and for the Správa železnic. The rate for timetable 2022 is set at 1 × B1 per minute of delay if the difference is to the detriment of the RU and at 1 × B2 per minute of delay if the difference is to the detriment of the Správa železnic.

- d. The calculation period is a calendar month. The accounting period is one calendar year.

2. Evaluating All the Movements of the RU, Determining the Level of Responsibility:

- a. The number of trains of a given RU included in the penalty regime is compared with the number of all the trains of that RU in a given calendar month.
- b. If the number of trains covered by the penalty regime is greater than or equal to 20% of the total number of trains, the party responsible for 60 or more minutes of all increments of delay of all trains covered by the penalty regime in a given calendar month shall pay the other party a penalty. The amount of this sanction is the same for the RU and for the Správa železnic and for the timetable 2022 it is $1 \times C$, for the application of the sanction both limiting conditions must be met,
- c. The calculation period is a calendar month. The accounting period is one calendar year.

Basic penalty rates

Process	Symbol	Rate
Evaluation of individual journeys of the RU - minutes of delay due to the RU	B1	1,- Kč
Evaluation of individual journeys of the RU - minutes of delay due to the Správa železnic	B2	4,- Kč
Evaluation of all journeys of the RU	C	1.000,- Kč

5.7.4 Governance and dispute resolution system

5.7.4.1 PDV Railway

The railway operator and the RU are obliged to discuss each applied sanction with each other in advance, by the end of the following calendar month after the relevant calendar month in which the reason for applying the sanction arose.

The method of resolving disputes is described in Annex "K".

5.7.4.2 PKP CARGO INTERNATIONAL

The railway operator and the RU are obliged to discuss each applied sanction with each other in advance, by the end of the following calendar month after the relevant calendar month in which the reason for applying the sanction arose.

The method of resolving disputes is described in Annex "K".

5.7.4.3 Správa železnic

Approval or non-approval of the cause of the increase of the delay of each train by the RU is possible within 10 working days after the assignment of the delay code in the given transport point of the train path. If the RU does not comment on the causes of the delay within this period, the assigned codes for the reasons for the delay shall be deemed to have been agreed by the RU. Any disagreement of the RU is checked by the Správa železnic, in case of acceptance of the RU's opinion, the delay code is modified, otherwise confirmed. This opinion is considered final.

After the expiry of the period of 10 working days from the assignment of the delay code at the given transport point, any cause of disruption of the operation of rail transport, on which the RU did not comment in the IS ISORŽ, is also considered a final opinion.

The Správa železnic assigns to each increase in delay the appropriate disturbance code according to its cause (see Annex "M" of this Network Statement) and makes it available to the RU in IS ISORŽ. When determining the violation code, the Správa železnic is based only on the information known to it. The RU can express his disagreement with the assigned violation code through the IS ISORŽ within 10 working days from the time it is made available in the IS ISORŽ. The RU's objections made after the expiry of the 10-day period are not considered. If the RU

violates the RU's violation code (see Appendix "M" of this Network Statement), it must state the reasons and facts on the basis of which it violates the RU's code in the disagreement. If the RU does not provide reasons for disagreement and facts in favor of the RU's opinion, they will not be taken into account in the dispute. If the RU does not agree, the Správa železnic will assess and discuss the disputed case within a period of 45 days. The following conditions may occur – Správa železnic:

- a) Agree - end of the case.
- b) Chooses a compromise - updates the original proposal and creates a new violation.
- c) Disagree - insists on the original proposal.
- d) It is inactive - after 45 days automatic change of the violation code to D2 (responsibility of the Operator) and termination of the case.

In the case pursuant to letters b) and c), the RU shall again comment on the proposal. The following cases may occur - RU:

- a) Agree - end of the case.
- b) Disagree - change of opinion to "pass to arbitrator".
- c) It is inactive - automatic consent after 10 days and termination of the case.

If the RU does not record its possible disagreement in the IS ISOŘ within this period, the final opinion is confirmed.

The Správa železnic has the possibility, in exceptional cases, to reopen any case of liability for delays. In that case, however, all the procedure (including time limits for comment) must be followed as in the new case.

Disputed cases are continuously referred to the arbitrator by the Správa železnic. The time limit for resolving these cases by the arbitrator is 10 working days.

The Správa železnic will pay the arbitrator a price of $1 \times A$ without VAT for each decided dispute (see the following table). The RU shall pay the Správa železnic a price of $1 \times A$ without VAT for each disputed decision decided by the arbitrator in favor of the Správa železnic (ie if the arbitrator confirms the opinion of the Správa železnic or if the RU is identified by the arbitrator as the one who caused the delay). If the decision of the arbitrator is not unambiguous in favor of the RU or the Správa železnic (ie in the event that the arbitrator does not confirm the position of either the Správa železnic or the RU and does not clearly identify the Správa železnic or the RU as the one to blame for the delay, or the arbitrator's opinion is based on facts that were not known to the Správa železnic or the RUs as part of the assessment of the case), the RU shall pay the Správa železnic a price of $0.5 \times A$ without VAT. If the arbitrator does not decide the disputed case within 10 working days through his own fault, the arbitrator shall pay the Správa železnic a contractual penalty in the amount of $2 \times A$ and the Správa železnic shall pay the RU a contractual penalty in the amount of $1 \times A$. The calculation period is a calendar month.

The basic price of the arbitrator for each decided dispute

Process	Symbol	Price
Problem solving	A	4.000,- Kč

If the arbitrator does not resolve the dispute within 10 working days through no fault of his own, no sanction shall be paid. However, in such a case, the arbitrator is obliged to document to the Správa železnic and the RU the reasons which prevented him from issuing the decision.

In cases decided by the arbitrator, the Správa železnic shall adjust the record in the IS ISOŘ according to the result of this decision; This solution to the dispute is considered to be a confirmed final opinion.

More detailed information on the dispute resolution system is provided in Appendix "L" of this Network Statement.

The application of the procedure set out in the previous paragraph does not affect the right of the RU or the Správa železnic to submit the dispute to the competent court of the Czech Republic for resolution.

5.8 Changes to Charges

The Správa železnic reserves the right to change the prices listed in Chapters 5.4 a 5.5. Changes to these prices are announced by the Správa železnic in the form of an amendment to the Network statement and a notice on the Railway Operation Portal; other railway operators (see Chapter 1.6) inform about the price changes separately. The change of prices for the allocation of railway capacity mentioned in chapter 5.3 the Správa železnic does not currently plan to do so in the coming years, but it cannot be ruled out. The Správa železnic does not exclude any further price adjustments listed in Chapter 5.3 in the event of an unplanned increase in economically justified costs or a change in the amount of the subsidy provided to the Správa železnic or for other justified reasons. The Správa železnic does not currently have more detailed information.

5.9 Billing Arrangements

5.9.1 Billing Arrangements on the line operated by PKP CARGO INTERNATIONAL a.s.

Prices for the use of the Milotice nad Opavou – Vrbno pod Pradědem regional railway for the purpose of train movement are invoiced by PKP CARGO INTERNATIONAL a.s. to the RUs by the 15th day after the end of the calendar month in which the movement of the respective train was terminated. The tax document includes the total final price for performance in passenger or freight transport, VAT, and the total price including VAT. The tax document has a due date of 30 calendar days.

Payment identification for using the railway for train movement is as follows:

Account = 1000483318/3500 maintained with ING Bank N.V.

Variable symbol = tax document number

Specific symbol = period of actually made performances subject to charging, in mmyyyy format (e.g. 052013)..

5.9.2 Billing Arrangements on the lines operated by PDV RAILWAY a.s.

PDV RAILWAY a.s., as a railway operator, does not allocate railway capacity. The RU requests Správa železnic for the allocation of railway capacity on regional railways operated by PDV RAILWAY a.s. Prices for railway capacity allocation are then invoiced to the RUs by Správa železnic.

PDV RAILWAY a.s. invoices the price for the use of railway for the purpose of train movement to RUs under the contract for operation of rail transport between the RU and the railway operator. Due date of the tax document is 30 days. The tax document includes a billing document, which distinguishes performances in passenger and freight transport. Furthermore, the number of trains, train kilometres and gross tonne kilometres are stated at each kind of transport. Other data are only stated if this is agreed in the contract for rail transport operation.

Other services required by the RU (e.g. long-term standstill of vehicles, re-fueling, train crew training, etc.) are provided by the railway operator in agreement with the RU under a concluded contract. For other services provided by PDV RAILWAY a.s., as the railway operator, only the actual and demonstrably proven costs are invoiced to RUs.

5.9.3 Billing Arrangements on the lines operated by Správou železnic

Prices for railway capacity allocation are invoiced by Správa železnic to applicants by the 15th day after the end of the calendar month in which railway capacity was allocated. The tax document includes the total final price for the allocation of the railway capacity, VAT, and total cost including VAT. The tax document has a due date of 30 calendar days. The Czech crown (CZK) is the official currency for billing and payments.

Payment identification for railway capacity allocation is as follows:

Account = 14606011/0710, IBAN CZ13 0710 0000 0000 1460 6011, BIC: CNBACZPP
maintained with the Czech National Bank

Variable symbol = tax document number

Penalties for unused or cancelled allocated railway capacity are invoiced by Správa železnic to applicants on a quarterly basis. The subject of invoicing is the sum of sanctions in individual months of the given quarter. If the calculated penalty per calendar month is less than CZK 1,000, the resulting amount of the quarterly invoice is not included. The tax document has a due date of 30 calendar days.

Payment identification for unused or cancelled allocated railway capacity is as follows:

Account = 14606011/0710, IBAN CZ13 0710 0000 0000 1460 6011, BIC: CNBACZPP
maintained with the Czech National Bank

Variable symbol = tax document number

The prices for the use of the track by the train (including the inclusion of the incentive effect for vehicles equipped with ETCS) shall be invoiced by the Správa železnic to the RUs by the 15th day after the end of the calendar month in which the train ran. The tax document includes the partial price for passenger transport services (including the price for the use of access roads for passengers), freight transport services, VAT and the total price including VAT. The due date of the tax document is 30 calendar days.

Payment identification for using the track for train movement is as follows:

Account = 10006-14606011/0710, IBAN: CZ53 0710 0100 0600 1460 6011, BIC:
CNBACZPP maintained with the Czech National Bank

Variable symbol = tax document number

The mutually discussed penalty amounts resulting from the penalty system and the amounts for disputes conducted by the arbitrator shall be invoiced by the Správa železnic and the RU by the 15th day of the fourth calendar month after the end of the calendar month in which the reason for the sanction arose. The tax document includes the total final price for all agreed sanctions in the relevant calendar month. The due date of the tax document is 30 calendar days.

Payment identification for negotiated sanctions invoiced to RUs by Správa železnic is as follows:

Account = 14606011/0710, IBAN CZ13 0710 0000 0000 1460 6011, BIC: CNBACZPP
maintained with the Czech National Bank

Variable symbol = tax document number

Prices for track access to services in Chapter 5.3 and for services in Chapters 5.3, 5.4 and 5.5 (if specified) are invoiced separately. The due date of the tax document is 30 calendar days.

Payment identification for railway access to services is as follows:

Account = 14606011/0710, IBAN CZ13 0710 0000 0000 1460 6011, BIC: CNBACZPP
maintained with the Czech National Bank

Variable symbol = tax document number

Neither Správa železnic nor the RUs are authorised to make the payment of invoiced prices and sanctions pursuant to Chapter 6 by form of a unilateral set-off.

6 Operations

6.1 Introduction

The RU is obliged to comply with the applicable legislation and to obey the instructions of the railway operator concerning the performance of the transport service and safety measures.

The RU is obliged to notify the railway operator of all incidents on the train before the journey takes place and immediately upon occurrence during the journey.

Parking of railway vehicles on the network operated by the Správa železnic is possible only with the express consent of the Správa železnic. It is possible to parking vehicles outside the facility services Storage sidings in two modes:

- **Short-term technological parking of railway vehicles** - Short-term technological parking of railway vehicles is considered to be the short-term parking of railway vehicles during train turnover between individual planned performances or the parking of trains during the transport saddle between two peaks or between individual performances. The maximum length for short-term technological parking of railway vehicles is 168 hours.
- **Short-term operational parking of railway vehicles** - Short-term operational parking of railway vehicles is considered to be the short-term parking of railway vehicles during transport, or before or after the train runs for operational reasons on a predetermined traffic track, and only on the basis of the express consent given by the operational dispatcher. The operational dispatcher will grant approval for parking only on the condition that the occupation of the given traffic track does not in any way limit the planned train runs for the entire duration of the approval. The RU is obliged to organize the journeys of its trains and rolling stock in such a way as to vacate the relevant track at the latest when the granted consent expires. The maximum length for short-term parking of railway vehicles is 168 hours.

For the short-term technological parking of railway vehicles on tracks with a special regime, special conditions for granting consent apply. The list of tracks with a special regime is published on the Railway Operation Portal. The conditions for granting approval for the parking of railway vehicles are described in Annex "N" of this Network Statement.

6.2 Operational Rules

The rules for the operation of the railway are determined by the Railways Act and its implementing regulations. The list of legal regulations concerning railway transport is available on the website of the Ministry of Transport (<https://www.mdcr.cz/Dokumenty>)

In accordance with the Commission Decision of 14 November 2012 concerning the technical specification for interoperability relating to the 'operation and traffic management' subsystem of the rail system within the European Union and amending Decision 2007/756 / EC (Commission Decision 2012/757 / EU) on tracks operated by the Správa železnic. On the basis

of an international agreement, the railway employees of the neighboring (Austrian) administration can use the official language of that administration at the Břeclav and Šatov interchange stations. Employees of the neighboring (Austrian) administration are considered employees of the RU that operates rail transport in these railway stations on the basis of the Single Safety Certificate issued only for the territory of the Republic of Austria with the extension to operations to stations near the border in the territory of the Czech Republic (see chapter 3.2.4) and contracts between the RU and the Správa železnic as capacity allocator and railway operator with limited validity only for the relevant cross-border sections (see chapter 3.3.2.1).

For European freight corridors (see chapter 1.7.1), other specific rules published in the Corridor Information Document of each corridor (CID) apply. These specific rules only apply to interstate freight trains running according to the rules of a specific freight corridor

6.3 Operational Measures

6.3.1 Principles

Legislation in rail transport:

www.mdcr.cz, or

<https://provoz.spravazeleznic.cz/Portal/ViewArticle.aspx?oid=1397525>

Other regulations:

<https://provoz.spravazeleznic.cz/Portal/ViewArticle.aspx?oid=1269233>

6.3.2 Operation Regulation

In accordance with the provisions of the Railways Act, the Správa železnic issues internal regulations determining the rules for organizing and securing traffic on national and regional railways operated by the Správa železnic, which are binding on RUs. Their list is available on the Railway Operation Portal and their list is also part of the contract on the operation of rail transport.

The basic internal regulations determining the rules for organizing and securing traffic on national and regional railways are supplemented, if necessary, on lines where railways come into contact with railways in the territory of neighboring states (see chapter 2.2.2), and on lines with remotely controlled signaling equipment. modified, other documents of the railway operator.

The Správa železnic has procedures in place to identify the need for possible cooperation with other actors in areas where they share interfaces and which could affect the implementation of appropriate risk management measures in accordance with the requirements of Commission Regulation (EU) No 1169/2010 of 10 December 2010. On a common safety method for assessing conformity with the requirements for obtaining railway safety approvals.

The basic internal regulations determining the rules for organizing and securing traffic on leased regional railways are set by the operator of the relevant regional railways.

Contacts for regional railway operators are given in Chapter 1.6.

6.3.3 Disturbances

The basic operating rules in the event of an emergency and the associated foreseeable and unforeseen problems are set out in the Railways Act and Decree No. 376/2006 Coll., On the system of safety of railway operation and rail transport and procedures in the event of emergencies on railways, as amended. These basic operating rules are further elaborated by the internal regulation of the relevant railway operator.

In the event of a train disruption caused by an emergency, the infrastructure manager shall take all necessary steps to restore the normal situation. To this end, it has a contingency plan setting out the public authorities to be informed in the event of serious accidents or serious disruption to train services.

The Správa železnic shall allow applicants to use other free track capacity for train journeys on a suitable diversion path accepted by the applicant.

An exceptional interruption of service on the line or its significant reduction affecting the RU's train for more than 10 minutes shall be demonstrated by the railway undertaking immediately after the obstacle is identified or the unforeseen closure decision is made, including the expected duration of the interruption and the reason or cause interruption of operation.

In the event of the announcement of regulatory measures in railway transport in crisis situations, in emergencies, and if it is absolutely necessary as a result of an emergency or other event that causes the interruption of operations, the Správa železnic may limit the allocation of track capacity and limit or i to withdraw the allocated runway capacity on the section concerned for as long as is necessary to resume operations.

6.4 Tools for Train Information and Monitoring

GRAPP is a web application designed to support the national organization of train journeys on the infrastructure network of the Správa železnic. It provides real-time data and presents the movement of all currently running trains in a graphical user interface. It maps the entire life cycle of a train, starting with its departure from the station of departure or entering the Správa železnic network after the end of the journey at the destination station or exiting the Správa železnic network. In addition to the current position of the train, GRAPP clearly provides information on the course of the journey already made, as well as data on the next planned journey, including the prediction of possible delays.

The spectrum of information within GRAPP is provided in three basic levels and is directly dependent on the user role of the accessing user.

- The anonymous user role does not require any authorization and authentication. For the role of the anonymous user, information on the running of trains running in the mode of public passenger transport is presented. At the same time, GRAPP users can also access data from information boards in the selected station or basic data on the equipment of individual stations.
- The role for the RU (or another authorized entity in the role of RU) requires the establishment of a user account and is subject to the authorization and authentication of the accessing user. Information on all public passenger transport trains and at the same time on all trains running on the license of this RU is made available to this role. Extended information on the analysis and composition of the train running on the license of the RU concerned is also available for this role.
- The role for the infrastructure manager is primarily intended for users of the Správa železnic and provides information on the running of all trains on the Správa železnic's network.

Access to the GRAPP web application is free. The user account can be obtained through the support of: ppdpristup@spravazeleznice.cz.

GRAPP also has a web service that enables data communication with third-party information systems. More information on data communication options can be found on the website <https://provoz.spravazeleznice.cz>.

The RNE TIS application can also be used to monitor international train journeys. TIS is a web-based application that supports international train management by delivering real-time train data concerning international trains. The relevant data are obtained directly from [IM name]'s systems and all the information from the different IMs is combined into one train run from departure or

origin to final destination. In this manner, a train can be monitored from start to end across borders.

RUs and terminal operators may also be granted access to the TIS and they can join the RNE TIS Advisory Board. All members of this Board grant all other members full access to TIS data if they are involved in the same train run. Without it, mutual agreements have to be signed between RUs and between RUs and terminal operators.

Access to TIS is free of charge. A user account can be requested via the RNE TIS Support: support.tis@rne.eu.

More information can be found on <http://tis.rne.eu>.

7 Service facilities

7.1 Introduction

Service facilities in accordance with the provisions of the Railways Act means railway stations, stops, parking tracks, service stations and other technical facilities, which are specially designed by their operator to provide services directly related to the operation of rail transport on national or regional railways or on publicly accessible siding.

Pursuant to the provisions of Article 5 of Commission Implementing Regulation (EU) 2017/2177, service facility operators shall establish a description of service facilities for the service facilities and services they operate. The purpose of the description of service facilities is to inform applicants, authorities and other stakeholders about the service facilities and the conditions for capacity allocation and their use. Service facility operators shall publish a description of the service facility free of charge in one of the following ways:

- a) by publishing on its Internet portal or on the common Internet portal and providing a link to be included in the path declaration to the relevant allocator;
- b) providing the relevant ready-to-publish information to be included in the path statement to the relevant allocator.

The content of the description of service facilities is defined in Commission Implementing Regulation (EU) 2017/2177. A common template for the description of service facilities, developed by the railway sector in cooperation with the regulatory bodies, can be used to create a description of the service facilities. A sample description of service facilities is given in Annex "G" in both Czech and English versions.

7.2 Service Facility Overview

On the Infrastructure Operation Portal, Správa železnic offers a list of service facilities available at railways, where Správa železnic is the capacity allocator. This list contains data in the extent that was provided by the relevant service facility operator. Operators of service facilities available at railways, where Správa železnic is the capacity allocator, will provide Správa železnic with information on facilities operated by them for the purpose of publishing these in the aforementioned list in the given extent:

- Name of the service facility,
- Identification whether the service is operated by a single operator (simple service facility) or multiple operators (complex service facility),
- Identification of the type of service facility or its operating component in accordance with Decree No. 76/2017 Coll., on the Content and Extent of Services Provided by the RU to the Railway Operator and the Service Facility Operator,
- Contact point, where the facility is connected to nationwide or regional railway, including kilometric location,
- Information on whether the service facility is part of the European Freight Corridor (RFC - see Chapter 1.7.1) or not,
- Identification of the service facility operator, including contact details,

- Information where a description of the service facility is published in accordance with the provisions of Commission Implementing Regulation (EU) 2017/2177..

These data will be sent by the operator of the service facility electronically to the e-mail address ppdpristup@spravazeleznic.cz and in case of change of the given data it will be updated in the same way.

If the operator of the service facility requests the publication of the description of the service facility by the Správa železnic, it shall provide the Správa železnic with a description of the service facility ready for publication in the Czech and English language versions. The operator of the service facility shall send individual descriptions of the service facility electronically in pdf format to the e-mail address ppdpristup@spravazeleznic.cz at least 15 calendar days before the required date of publication. Except for the unification of the file name, the Správa železnic is not entitled to make any changes to the submitted documents. The Správa železnic is not responsible for the content of the submitted documents or for the non-publication of these documents, unless they are sent to the Správa železnic in accordance with this chapter.

7.3 Service Facilities Managed by the Správa železnic

The Správa železnic as a Railway Facilities Service Operator shall publish the conditions for the provision of services through service facilities accessible from the railways where the Správa železnic is the allocator, the price for the provision of these services and the possible price for using the siding to connect the Service Facilities in accordance with Commission Regulation (EU) 2017 / 2177 and the provisions of the Railways Act on the Railway Operation Portal.

Annex "A"

Rejstřík použitých pojmů

For purposes of this Statement, following basic definitions of terms are used:

- 1) "Ad-hoc" is the process of negotiating individual requests of the applicants for allocation of infrastructure capacity out of scope of elaborated timetable;
- 2) "Railway undertaking" is a physical or legal person registered in the Commercial register carrying out rail transport operation pursuant to the Rail Act
- 3) "Transport services" means the provision of transport on all days of the week, in particular to schools and educational establishments, to public authorities, to work, to health establishments providing basic health care and to meeting cultural, recreational and social needs, including transport back, contributing to the sustainable development of the territorial district.
 - a. Regions and municipalities in their independent competence by public passenger transport services by public passenger transport and public regular transport and their connection,
 - b. The State, through its organizational unit, by public passenger rail passenger transport services of national transport trains of a supra-regional or international character;
 - c. The Ministry of Transport in agreement with the Ministry of Defense for the needs of the state.
- 4) "Railway" is the infrastructure intended for movement of railway vehicles including fixed equipment necessary for ensuring safety and fluency of railway transport;
- 5) "Railway infrastructure capacity" is, for the purposes of operation of railway transport, the usable permeability of the rail within the scheme of requested train paths in a section of railway infrastructure over a certain period;
- 6) "Combined transport" is transport of goods that uses transport units enabling transloading to another mode of transport without manipulation with its content
- 7) "Coordination" is the process through which the allocation body and applicants try to resolve situations when multiple applications for infrastructure capacity exists that are in conflict;
- 8) "Infrastructure manager" is the railway operator;
- 9) "manipulation train" is a train intended for carrying out cargo from a train-formation station to neighbouring or intermediate stations or for carrying in cargo from neighbouring or intermediate stations to a train-formation station,
- 10) "Exceptional load" is a load that causes, by its outside dimensions, weight or nature, with regard to railway equipment or rail vehicles, difficulties during transport along railway infrastructure and therefore can only be transported under special technical or operational conditions;
- 11) "Výlukový jízdní řád" means the Rozkaz o výluce (ROV). A supplementary measure in the form of an výlukový nákrešný jízdní řád may be issued to the Rozkaz o výluce.
- 12) "Rozkaz o výluce" means a document determining the conditions for exclusion, activation, restoration of the correct operation of the relevant track equipment and, if necessary, containing specific measures to implement the anticipated exclusion. The Rozkaz o výluce is intended for organizing the operation of the railway and rail transport during the implementation of the exclusion, indicating any measures necessary to be taken before the exclusion starts and after the exclusion ends.
- 13) "Výlukový nákrešný jízdní řád" means an outline timetable constructed for a given exclusion or a series of exclusions with regard to restrictions on the operation of rail transport during the implementation of the exclusion, or exclusion. The Výlukový nákrešný jízdní řád is a supplementary measure to the Rozkaz o výluce.
- 14) "Operator of railway" is a subject carrying out traffic control and organization of railway transport within a network;
- 15) "Capacity enhancement plan" is a measure or a set of measures with a schedule of realization which are designed to mitigate problems with insufficient infrastructure capacity that result in declaring a part of infrastructure to be overloaded;

- 16) "fee" (for purposes of this Network Statement) is a price pursuant to Art. 33 of Act No 266/1994 Coll. on Rail Systems as amended, calculated according to conditions specified in this Network Statement.
- 17) "Operation of railway" includes activities through which railway is supported and operated and railway transport is organized;
- 18) "Operation of railway transport" is an activity during which a legal relationship arises between the operator of this transport and the subject whose transport need is being met; the subject of this relationship is transport of passengers, goods or animals, or an activity through which business according special regulations is ensured;
- 19) "Railway operator" is an individual or corporate body listed in the Trade Register, which RUs out operation of railway according to the Railway Act;
- 20) "Serviceability of railway" is a technical condition of railway ensuring its safe and fluent operation;
- 21) "Overloaded infrastructure" is a part of infrastructure where the demand for infrastructure capacity cannot be met during certain time periods even after coordination of various requests for infrastructure capacity;
- 22) "Allocation body" is a subject which is represented by the Správa železnic (if the infrastructure in question is owned by the state) or the owner of the infrastructure (if the infrastructure in question is not owned by the state);
- 23) "Allocation" is the process of allocation of infrastructure capacity;
- 24) "Framework agreement" is a general agreement setting the rights and duties of the applicant and allocation body regarding the infrastructure capacity that is to be allocated and fees that are to be charged over a period longer than the period of one working timetable;
- 25) "Framework path/day" is, for the purposes of determining price for capacity allocation, a movement of one train from starting station to destination station within 24 hours without change of kind and character of operated railway transport;
- 26) The term "station technology" means a set of activities with the train set that the RU plans to carry out at a specific transport point. This is, for example, the provision of information about the shutdown of railway vehicles (indicating the planned time of shutdown, including the indication with whom and how the shutdown was discussed), the continuation of transport by another train (indicating the direction and date of the next journey, or train number) or the repositioning of railway vehicles on a siding or service facility of the Railway Administration (including specifying what and specifying with whom and how the use of the service facility was discussed)..
- 27) "Public interest", in the area of public railway passenger transport, is the interest in ensuring basic transport needs of population; decisions on applying the public interest while ensuring transport services are made by relevant public administration body or local government;
- 28) "Train path" is a portion of infrastructure capacity that is necessary for movement of the train between two places over given period of time;
- 29) "sidings train" is a train designed for servicing sidings branching from a wide track and returning to the station (directly neighbouring with the open line section which the sidings branch from) from which it has been dispatched. Sidings trains are also trains designed for rides to a loading point and returning to the station(directly neighbouring with the open line section where the loading point is situated) from which they have been dispatched-
A sidings train can also serve for a ride from a station to the sidings directly branching from this station or vice versa.
- 30) "Exhausted capacity" is a situation when after coordination of requested paths and consulting with applicants, requests for free infrastructure capacity cannot be met in a satisfactory way,
- 31) "closure" is an adaptation of transport and operational infrastructure installation usage requiring the adoption of special technological and technical measures leading to rail operation limitations or rail transport operation limitations. A closure pursuant to this Network Statement is not an infrastructure capacity limitation caused by operation extraordinary situations (e.g. safety installations defects and breakdowns, rail vehicles' defects etc.) up to the time these defects are eliminated or subsequently established as a closure.

- 32) "Service facilities" is a designation for facilities including the terrain, building and equipment which have been set up as a whole or parts to allow providing one or more services directly related to operating rail transport on a nationwide or regional network or on publicly accessible sidings.
- 33) "Applicant" is a common designation for an applicant for capacity which is in possession of a valid licence (RU) and an applicant for capacity which is not in possession of a valid licence. An applicant is also a RU that uses railway infrastructure capacity allocated to an applicant which is not in possession of a valid licence;

Annex "B"

Table A

Overview of selected data of the nation-wide rail system and regional rail systems

Meaning of individual columns and symbols used:

Column number:	1 – number of line
	2 – name of the railway line beginning
	3 – name of the railway line end
	4 – kilometre position of the railway line beginning
	5 – kilometre position of the railway line end
	6 – total construction length of the railway line specified in km
	7 – maximum line speed stated in km.h-1
	8 – standard length of passenger trains stated in m
	9 – standard length of freight stated in m
	10 – maximum length of freight stated in m
	11 – maximum gradient of the line stated in ‰
	12 – approved limits of line classes

Comment to column 10 maximum length of freight stated in m:

In the case where the TTP of line contains sections with different a maximum allowed train length, is shown in column 10 of its peak value. All sections with different maximum allowed length are shown in Table 6 of TTP.

The trains longer than the TTP set normative length, must run in accordance with the provisions of the Správa železnic SŽ D1 ČÁST PRVNÍ, Art. 256, as amended.

The length of passenger train on the lines with regular long distance passenger transport is set by normative for long distance passenger trains

The data contained in Annex "B" reflect a condition known at the date of Statement. Current data on the state and regional railway lines operated by Správa železnic publishes information system DYPOD (<http://provoz.spravazeleznice.cz/dypod>).

Overview of selected data of the nation-wide rail system and regional rail systems

1	2	3	4	5	6	7	8	9	10	11	12
100 00	Plzeň hlavní nádraží	Cheb	350,123	456,007	106,416	150	300	515	640	12,0	D4/D3
101 00	Aš	Hranice v Čechách	27,285	15,898	16,106	40	60	115	115	27,5	B2
102 00	Františkovy Lázně	Aš státní hranice	7,213	29,585	23,290	70	250	393	393	13,0	D3
103 00	Cheb	Vojtanov státní hranice	73,615	51,325	19,591	90	250	469	600	13,0	D3
104 00	Cheb	Cheb státní hranice	150,539	140,587	10,520	90	350	510	670	7,6	D4
105 00	Mariánské Lázně	Karlovy Vary	0,389	2,617	56,117	60	60	300	300	25,0	C3/C2
106 00	Domažlice odbočná výh.č.401	Planá u Mariánských Lázní	5,842	0,027	81,726	60	45	156	180	24,0	C3
107 00	Svojšín	Bor	0,132	14,904	15,641	60	35	142	199	19,0	C3
108 00	Pňovany	Bezdrůžice	0,376	24,087	24,588	60	40	109	118	26,5	C2
120 00	Chomutov	Cheb	126,192	236,297	111,954	100	200	427/ 409	626	13,3	D4
121 00	Tršnice	Františkovy Lázně	0,402	3,724	4,302	60	250	469	600	8,6	D4
122 00	Tršnice	Luby u Chebu	0,509	20,955	20,446	60	30	140	140	24,7	C2
123 00	Sokolov os.n.	Kraslice st.hr.	0,574	27,452	26,877	60	60	150	150	16,6	B2/D3
124 00	Krásný Jez	Nové Sedlo u Lokte	0,203	18,083	19,440	60	200	615	615	34,3	B2/C2
125 00	Chodov	Nová Role	0,418	6,263	7,165	40	20	175	175	10,0	D4
126 00	Karlovy Vary-Sedlec	Potůčky státní hranice	5,221	46,199	40,957	60	50	300	300	26,0	C2
127 00	Dalovice	Merklín	10,325	0,040	11,370	50	30	130	130	30,0	C2
128 00	Kadaň-Předměstí	Kadaň-Prunéřov	26,404	32,376	6,019	75	40	110	110	0,0	D2
129 00	Kašnice	Kadaň-Předměstí	0,038	26,404	26,957	70	40	110	110	28,0	C3/A1
131 00	Kadaňský Rohozec	Vilémov u Kadaně	8,825	17,779	8,989	40	40	110	110	22,0	B2
132 00	Chomutov	Vejprty státní hranice	0,708	35,391	57,677	90	45	330	330	21,3	A1
133 00	Droužkovice	Dubina odbočka	1,075	5,707	5,724	100	100	700	700	11,7	C4
140 00	Most	Chomutov	48,681	65,712	24,202	110	200	427	700	12,9	C4
141 00	Chomutov město	Chomutov seř.n.	0,118	2,551	2,518	40	N/A	600	700	9,0	C4
142 00	Březno u Chomutova	Chomutov	116,223	124,294	9,933	100	100	430	575	0,0	C3
143 00	Dolní Rybník odbočka	Jirkov	0,038	1,874	2,000	50	90	235	235	23,5	B2
144 00	Třebošice	Most nové nádraží	1,603	3,955	3,599	60	N/A	456	650	5,3	C4
145 00	Most	Most nové nádraží	47,228	4,458	5,161	60	100	456	650	7,8	D4
146 00	Most nové nádraží	Louka u Litvínova	4,458	11,686	8,292	60	100	300	300	19,6	C3

1	2	3	4	5	6	7	8	9	10	11	12
147 00	Louka u Litvínova	Litvínov	53,952	55,683	1,477	50	100	350	350	0,0	B2
148 00	Louka u Litvínova	Moldava v Krušných horách	132,920	158,081	25,370	50	100	300	300	35,0	A1
149 00	Louny	Most	95,228	121,101	25,977	80	120	350	441	0,0	C3
160 00	Ústí nad Labem hlavní nádraží	Most	0,507	48,681	47,468	120	200	427	700	0,0	D4
161 00	České Zlatníky odbočka	Obrnice	234,800	233,182	1,649	70	120	600	660	4,9	C3
162 00	Oldřichov u Duchcova	Louka u Litvínova	42,781	53,064	11,532	80	80	350	664	16,6	D4
164 00	Děčín hl.n.	Oldřichov u Duchcova	0,191	39,443	41,304	80	60	300	300	29,3	A1/B2
165 00	Ústí nad Labem západ	Bílina	4,831	25,339	27,131	60	90	533	691	10,6	D4
166 00	Řetenice	Lovosice	0,589	35,747	36,736	50	60	300	300	28,0	C3/D3
168 00	Ústí nad Labem západ St. 5	Ústí nad Labem západ vhb. 852	0,063	2,074	2,070	60	200	427	710	0,0	D4
169 00	Ústí nad Labem hlavní nádraží jih	Ústí nad Labem západ	0,082	0,978	4,008	50	165	630	650	0,0	D4
180 00	Plzeň hlavní nádraží	Žatec	1,070	203,390	106,350	70	120	390	634	19,5	C3
181 00	Rakovník	Bečov nad Teplou	0,650	87,262	88,799	60	40	315	315	30,0	B1/C3/B1
182 00	Protivec	Bochov	0,200	16,823	16,977	40	40	200	200	28,3	C3
183 00	Rakovník	Mladotice	1,354	38,558	37,775	60	100	525	525	24,0	C3/A1
184 00	Žatec západ	Žatec-Velichov	0,000	1,062	2,003	60	130	390	550	8,9	D4
185 00	Žatec	Březno u Chomutova	101,978	116,223	15,326	80	100	430	575	0,0	C3
186 00	Lužná u Rakovníka	Žatec	61,709	101,978	40,270	80	120	450	478	25,0	C2
187 00	Žatec	Obrnice	204,167	232,107	29,299	70	120	452	550	10,4	C3
188 00	Louny	Postoloprty	10,675	0,265	11,346	70	100	400/ 450	450	0,0	C3
189 00	Odb. Bažantnice	Odb. Vrbka	0,795	216,408	1,003	70	N/A	450	450	20,0	C2
191 00	Louny předměstí	Rakovník	44,765 0,308	0,650	45,143	70	50	400	436	18,0	C3
192 00	Krupá	Kolešovice	0,198	12,218	12,606	50	25	165	165	14,2	C2
200 00	Plzeň hlavní nádraží	Česká Kubice státní hranice	104,526	184,102	73,520	100	269	536	660	12,0	C3
201 00	Staňkov	Poběžovice	0,165	19,076	19,478	60	35	156	185	11,4	C3
202 00	Janovice nad Úhlavou	Domažlice	0,727	30,875	31,263	60	90	279	393	17,8	C3
203 00	Nýřany	Heřmanova Huť	0,112	9,669	10,090	60	30	86	86	20,1	A1
204 00	Klatovy	Železná Ruda-Alžbětín	48,334	0,000	48,321	90	170	237	237	19,0	C3
205 00	Plzeň hlavní nádraží	Klatovy	97,040	48,334	49,015	90	170	548	619	25,0	D3/C3

1	2	3	4	5	6	7	8	9	10	11	12
220 00	Nemanice	Plzeň hlavní nádraží	216,875 0,042	347,321	135,442	100	220	560	634	12,0	D3
221 00	Nepomuk	Blatná	24,230	0,229	25,053	50	60	66	187	24,5	B2
222 00	Horažďovice předměstí	Klatovy	0,292	58,071	59,475	65	90	473	550	15,0	C3
223 00	Strakonice	Volary	0,328	70,364	71,384	60	60	72	199	27,0	C2/B2
224 00	Březnice	Strakonice	0,234	49,093	50,112	50	40	85	192	21,1	B2
225 00	Putim	Ražice	0,246	2,624	4,288	70	N/A	608	608	3,7	D3
226 00	Číčenice	Volary	0,455	56,290	55,745	50	40	85	420	28,1	C2
227 00	Číčenice	Týn nad Vltavou	0,629	21,582	22,076	60	70	406/ 153	406/ 153	24,7	D4/A1
228 00	Dívčice	Netolice	0,471	13,785	13,867	60	30	128	134	14,9	C3
240 00	Horní Dvořiště státní hranice	České Budějovice	61,097	117,983	58,299	100	157	579	640	13,2	D3
241 00	Volary	České Budějovice, odbočná výh.č.502	56,290	0,000	88,694	70	125	162	213	21,2	C2/B2/C3
242 00	Černý Kříž	Nové Údolí	62,111	69,981	8,191	60	108	152	152	0,0	B1
243 00	Rybník	Lipno nad Vltavou	0,167	22,185	22,335	60	50	93	300	33,2	C2
260 00	České Velenice státní hranice	České Budějovice	163,100	211,641	50,679	100	90	450	640	12,5	D3
261 00	České Velenice	Veselí nad Lužnicí	1,157	54,506	54,484	100	90	465	603	6,0	D3
280 00	České Budějovice	Benešov u Prahy	117,983	133,570	115,568	160	220	535	630	14,9	D4
281 00	Tábor	Bechyně	0,010	24,303	24,304	60	80	83	83	41,0	B1
282 00	Tábor	Písek	1,750	59,460	58,719	70	70	380/ 30	561/ 30	16,1	C3/B1
283 00	Horní Cerekev	Tábor	0,451	69,093	69,444	70	60	286	627	24,4	C3
284 00	Olbramovice	Sedlčany	0,286	16,825	17,671	50	30	119	182	25,9	C3
285 00	Trhový Štěpánov	Benešov u Prahy	33,645	0,849	33,782	60	60	247	272	29,3	C3/C2
300 00	Benešov u Prahy	Praha-Uhřetěves	133,570	170,492	36,918	160	220	568	630	12,1	D4
301 00	Praha-Uhřetěves	Praha-Zahradní Město	170,492	178,095	7,581	160	220	568/ 420	700/ 500	0,0	D4
302 00	Praha-Zahradní Město	Praha-Vršovice	178,095	183,630	4,19	160	350	420	500	11,0	D4
303 00	Čerčany	Praha-Krč	0,470	6,393	51,088	80	145	170	212/ 247	24,0	C3/C2
304 00	Dobříš	Skochovice odbočka	0,666	29,580	29,956	50	100	102	198	23,4	C2
305 00	Světlá nad Sázavou	Čerčany	47,618	65,347	91,635	60	84	155/ 122	239	18,9	C3

1	2	3	4	5	6	7	8	9	10	11	12
320 00	Praha-Libeň	Praha hlavní nádraží	0,933	3,859	2,926	110	300	346	500	12,0	D4
321 00	Praha-Libeň	Praha-Holešovice Stromovka	0,199	5,071	6,731	80	310	680	695	6,8	D4
322 00	Praha Masarykovo nádraží-Hrabovka	Praha Masarykovo n.-Viadukt	0,006	0,595	0,559	40	N/A	455	658	0,0	D4
323 00	Balabenka odbočka	Praha Masarykovo nádraží-Sluncová	0,066 0,066	1,964 1,345	1,898	100	200	360	500	19,4	D4
324 00	Praha-Libeň	Praha Masarykovo nádraží	406,236 405,870	409,899	3,695	110	200	455	658	16,0	D4
325 00	Balabenka odbočka	Praha-Holešovice Rokytka	0,066 0,320	0,889 0,845	0,823	80	310	360	500	14,7	D4
326 00	Praha-Vršovice	Praha hlavní nádraží	182,5	185,369	2,809	100	310	420	500	5,5	D4
327 00	Praha hlavní nádraží	Balabenka odbočka	185,314	4,816	3,583	100	310	346	500	0,0	D4
328 00	Praha-Libeň	Praha-Vysočany	0,111	1,588	1,771	80	240	381	695	8,8	D4
329 00	Praha-Malešice	Praha-Zahradní Město	4,963	178,137	2,044	80	310	430	700	0,0	D4
332 00	Praha-Běchovice	Praha-Malešice	0,731	4,963	8,524	80	300	430	700	0,0	D4
333 00	Praha-Libeň	Praha-Malešice	1,508	3,821	2,371	80	310	595	695	0,0	D3
334 00	Praha-Hostivař	Praha-Malešice	0,514	3,242	4,687	80	220	595	695	0,0	D4
335 00	Praha-Vršovice	Praha-Vyšehrad výhybna	0,636	1,437	3,026	40	300	430	700	0,0	C3
336 00	Praha-Vršovice	DKV Praha PP Praha jih	182,454	0,852	0,744	40	350	420	700	0,0	C3
337 00	Praha-Krč	Praha-Vršovice	4,514	0,733	5,179	80	145	170	700	11,9	C4
340 00	Praha-Radotín	Beroun	10,237	39,210	29,283	100	310	666	680	11,2	D3
341 00	Rakovník	Beroun	41,881	0,042	43,483	70	65	326	536	11,4	C3
342 00	Praha-Smíchov	Beroun-Závodí	1,139	1,704	32,247	70	48	212	450	28,3	B2/C2
343 00	Praha-Smíchov severní zhlaví	Hostivice	2,985	19,212	20,000	70	80	414	541	15,4	C3
344 00	Rudná u Prahy	Jeneček odbočka	16,118	0,069	7,730	70	N/A	212	450	0,0	C3
345 00	Jeneček odbočka	Podlešín	0,068	47,520	29,198	70	100	509	541	0,0	C3
346 00	Jeneček vhb.č.5	Jeneček vhb.č.6	22,598	23,410	0,812	80	-	-	-	0,0	C3
347 00	Praha-Smíchov	Praha-Radotín	0,180	10,237	10,057	100	300	666	680	0,0	C3/D4
348 00	Praha-Zahradní Město	Odbočka Závodíště	7,766	14,492 14,448	14,517	75	250	430	700	12,7	D4
349 00	Praha hlavní nádraží	Praha-Smíchov	0,431	4,313	5,239	60	300	346	500	17,0	C3
360 00	Beroun	Plzeň hlavní nádraží	39,527	104,526	70,163	160	300	656	700	11,0	D4
361 00	Ejpvovice	Radnice	5,249	6,809	22,571	95	30	250	250	22,0	D3/B2

1	2	3	4	5	6	7	8	9	10	11	12
362 00	Rokycany	Nezvěstice	0,027	26,589	27,946	50	90/45	147	230	24,1	C3
363 00	Zdice	Protivín	101,354	0,022	103,294	75	100	345	535	18,3	C3
364 00	Rožmitál p. Třemšínem	Březnice	0,000	6,906	7,051	75	55	97	97	18,8	A1
365 00	Zadní Třeboň	Lochovice	0,076	26,350	26,894	60	60	114/ 147	114	26,6	C2
380 00	Praha-Holešovice Stromovka	Kralupy nad Vltavou	413,53	437,961	24,370	120	310	595	695	0,0	D4
381 00	Praha-Bubny	Praha-Holešovice Stromovka	412,924	413,530	0,668	80	160	455	695	0,0	D4
382 00	Praha Masarykovo nádraží	Praha-Bubny	409,995	412,924	2,926	80	220	455	695	0,0	D4
383 00	Praha-Bubny	Kladno	0,672	28,626	28,551	80	80	318/ 419	412/ 537	25,0	C2
384 00	Kladno	Lužná u Rakovníka	28,626	61,709	33,081	80	80	419	537	0,0	C2
385 00	Lužná u Rakovníka	Rakovník	0,315	42,971	9,755	60	80	419	537	0,0	C3
386 00	Kladno	Kralupy nad Vltavou	0,620	437,167	25,423	60	110	368	529	21,9	C3
400 00	Kralupy nad Vltavou	Lovosice	437,961	492,992	55,009	160	310	595	695	0,0	D4
401 00	Kralupy nad Vltavou	Louny	0,883	95,228	61,277	70	120	463/ 350	514/ 441	22,0	C3
402 00	Kralupy nad Vltavou předměstí	Velvary	2,753	10,002	8,006	40	50	95	95	26,2	C4
403 00	Vraňany	Lužec nad Vltavou	0,239	3,397	3,342	40	90	180	180	10,9	C3
404 00	Roudnice nad Labem	Straškov	1,484	13,270	13,379	60	30	220	220	0,0	D2
405 00	Vraňany	Libochovice	36,975	0,345	37,860	60	30	208	208	25,0	D3/C3/D2
406 00	Straškov	Zlonice	14,881	32,173	18,054	60	30	220	220	0,0	C3
407 00	Lovosice	Louny	0,614	0,675	35,049	60	60	169	229	18,3	C2
420 00	Lovosice	Děčín hlavní nádraží	492,992	540,164	47,168	160	160	595	695	0,0	D4
421 00	Děčín hlavní nádraží	Děčín státní hranice	1,026	11,859	10,832	120	429	650	695	3,6	D4
422 00	Děčín východ dolní nádraží	Děčín-Prostřední Žleb	457,725	458,961	2,727	50	150	650	695	6,9	D4
423 00	Děčín hlavní nádraží	Děčín východ dolní nádraží	1,792	456,065	3,127	90	190	650	695	12,4	D4
440 00	Nymburk hlavní nádraží	Ústí nad Labem-Střekov	323,297	431,472	108,145	120	156	567/ 517	680	18,0	D4
441 00	Ústí nad Labem-Střekov	Děčín východ	431,472	457,725	25,996	90	190	463	680	12,4	D4
442 00	Ústí nad Labem-Střekov	Ústí nad Labem západ	0,363	3,0161,461	4,030	50	200	517	680	0,0	D4
443 00	Žalhostice	Velké Žernoseky	0,051	0,785	1,266	40	100	300	300	25,0	C3
444 00	Mělník	Mladá Boleslav hlavní nádraží	0,498	14,623	49,545	50	40	143	177	0,0	C3

1	2	3	4	5	6	7	8	9	10	11	12
445 00	Lysá nad Labem	Milovice	0,633	5,800	5,928	70	160	233	233	23,5	C4
446 00	Lysá nad Labem	Praha-Vysočany	0,863	6,168	30,211	100	240	381	668	13,0	D3
447 00	Čelákovice	Mochov	8,785	4,014	4,044	60	40	133	133	17,5	C4
460 00	Česká Lípa hlavní nádraží	Liberec	0,692	143,166	61,574	100	100	342	542	25,5	C3/C2
461 00	Lovosice	Česká Lípa hlavní nádraží	36,931	84,564	48,468	60	100	272	272	29,4	B2
462 00	Benešov nad Ploučnicí	Česká Lípa hlavní nádraží	0,055	19,853	19,860	70	100	342	542	0,0	C3
463 00	Děčín východ	Benešov nad Ploučnicí	3,983	12,065	8,724	80	100	342	542	0,0	C3
464 00	Benešov nad Ploučnicí	Jedlová	12,065	40,115	28,770	70	10	450	450	0,0	C3
465 00	Česká Lípa hlavní nádraží	Rumburk	45,456	91,277	45,822	80	60	348/ 450	384/ 450	25,0	C3
466 00	Rumburk	Rumburk státní hranice	91,277	97,690	6,923	60	107	406	450	19,9	C3
467 00	Mikulášovice dolní nádraží	Rumburk	0,068	17,783	18,792	50	40	134	134	27,0	B2/C3
468 00	Rumburk	Dolní Poustevna státní hranice	0,020	26,271	26,252	60	40	137	282	28,6	C2/B2
469 00	Panský	Krásná Lípa	0,200	5,017	5,004	40	40	125	125	20,7	C3
471 00	Rybniště	Varnsdorf státní hranice	0,078	11,459	11,433	50	110	383	383	15,1	C3
472 00	Varnsdorf	Varnsdorf staré nádraží státní hranice	10,361	13,706	3,955	50	50	180	180	11,0	C3
473 00	Srní u České Lípy	Žizníkovo výhybna	0,520	3,474	4,884	80	130	634	634	5,2	C3
474 00	Mimoň	Mimoň staré nádraží	0,027	3,054	3,187	40	N/A	93	93	20,0	C2
480 00	Skály odbočka	Turnov	12,425	103,654	91,990	100	142	381/ 442	601/ 640/ 580	12,5	C4/C3
481 00	Balabenka odbočka	Praha-Vysočany	4,816	6,168	1,352	100	255	346	500	0,0	D4
482 00	Kralupy nad Vltavou	Neratovice	1,381	17,174	18,150	60	185	530	530	8,2	C4
483 00	Čelákovice	Neratovice	0,126	15,098	23,864	60	150	473	473	22,4	C3
484 00	Nymburk hlavní nádraží	Mladá Boleslav hlavní nádraží	0,562	29,359	30,774	100	190	574	640	6,1	C3
485 00	Mladá Boleslav hlavní nádraží	Mladá Boleslav město	14,687	21,195	7,571	60	200	574	640	0,0	C3
486 00	Mladá Boleslav město	Stará Paka	21,195	73,248	51,964	60	69	137	221	33,1	C2
487 00	Bakov nad Jizerou	Česká Lípa hlavní nádraží	0,625	45,445	45,416	100	125	379	558	14,5	C3
488 00	Bakov nad Jizerou-Zálučí odbočka	Dolní Bousov	37,380	22,836	14,999	60	69	221	221	15,0	C3/B2

1	2	3	4	5	6	7	8	9	10	11	12
491 00	Hradec Králové hlavní nádraží	Turnov	0,638	29,014	82,564	80	70	188	370/ 284	19,2	C3
492 00	Jičín	Nymburk město	41,433	0,499	45,151	70	55	318	318	17,1	C4
500 00	Jaroměř	Liberec	40,363	160,972	121,540	100	107	269	416/ 580	17,9	C3
501 00	Liberec	Hrádek nad Nisou státní hranice	0,750	21,769	21,017	100	268	291	405	13,2	C3
502 00	Liberec	Frýdlant v Čechách státní hranice	160,934	200,107	40,086	80	110	436	600	16,0	C3
503 00	Frýdlant v Čechách	Jindřichovice pod Smrkem	0,586	23,671	23,832	50	40	324	333	26,0	B2
504 00	Bílý Potok pod Smrkem	Raspenava	6,365	0,328	6,037	40	30	169	157	25,0	A1
505 00	Liberec	Tanvald	1,786	27,534	26,389	50	80	167	167	27,1	C3
506 00	Smržovka	Josefův Důl	0,232	6,776	6,545	40	40	80	80	28,3	C3
507 00	Tanvald	Harrachov státní hranice	27,534	40,111	12,577	60	139	220	220	0,0	A1
508 00	Železný Brod	Tanvald	0,148	16,824	17,474	60	106	282	282	31,5	C3
520 00	Kolín	Praha-Libeň	344,491	406,236	61,632	160	300	633	700	0,0	D4
521 00	Nymburk hlavní nádraží	Poříčany	1,332	1,141	16,521	100	80	351	700	15,3	C3
522 00	Pečky	Kouřim	0,664	3,001	16,996	60	40	138	188	16,3	C3
523 00	Bošice	Bečváry	12,986	3,820	10,929	60	40	164	180	16,7	C3
524 00	Praha-Běchovice Blatov	Praha-Běchovice	0,074 0,156	1,512 1,560	1,404	80	300	633	700	15,0	D4
540 00	Česká Třebová	Kolín	245,284	344,491	98,849	160	300	633	700	0,0	D4
541 00	Prachovice	Přelouč	21,556	1,800	21,661	50	30	444	487	26,9	C3
542 00	Heřmanův Městec	Borohrádek	0,305	46,769	47,626	60	60	253/ 190	405	19,7	C2
543 00	Chrudim	Chrudim město	0,622	1,114	1,582	30	40	190	289	19,6	C3
544 00	Choceň	Litomyšl	0,969	23,807	23,872	60	63	211	311	17,5	C3/C2
545 00	Letohrad	Ústí nad Orlicí	0,346	13,320	15,337	70	90	584	651	12,3	D4
546 00	Lichkov státní hranice	Letohrad	113,251	89,659	23,589	90	90	503	651	0,0	D4
547 00	Letohrad	Týniště nad Orlicí	89,659	50,296	40,543	100	115	356	424/ 450	21,0	C3
548 00	Častolovice	Solnice	0,717	15,613	14,959	60	45	315	450	20,3	C2
549 00	Doudleby nad Orlicí	Rokytnice v Orlických horách	0,450	19,694	19,892	50	40	207	410	28,3	C3/C2
551 00	Hanušovice	Lichkov	70,734	94,245	25,542	75	90	353	353	21,0	C3/A1

1	2	3	4	5	6	7	8	9	10	11	12
552 00	Štítý	Dolní Lipka	16,636	0,211	16,815	50	60	117	127	22,0	C3
553 00	Hanušovice-Morava	Staré Město pod Sněžníkem	1,892	11,447	9,582	50	30	57	57	20,8	C2
560 00	Kolín	Nymburk hlavní nádraží	298,487	323,297	24,720	120	220	567	700	6,7	D4
561 00	Babín odbočka	Nymburk hlavní nádraží	0,092 0,054	4,114	4,441	70	N/A	700	700	0,0	D4
562 00	Choceň	Velký Osek	0,949	0,346	100,890	100	160	532	680	10,9	D4/C3
563 00	Chlumeck nad Cidlinou	Obora odbočka	0,722	0,046	24,774	60	60	235	248	16,3	C4
564 00	Kolín-Hradištko	Prům.zóna TPCA	0,043	1,438	1,395	50	N/A	400	400	2,5	D3
580 00	Pardubice hlavní nádraží	Hradec Králové hlavní nádraží	1,337	21,835	22,260	100	170	578	680	9,6	D4
581 00	Opatovice nad Labem-Pohřebačka	Plačice odbočka	0,864	3,619	3,889	80	250	572	645	3,9	D4
582 00	Havlíčkův Brod	Pardubice-Rosice nad Labem	0,538	91,692	93,705	100	110	347/ 325	526/ 364	15,1	D4/C3
600 00	Hradec Králové hlavní nádraží	Jaroměř	23,144	40,363	18,036	100	170	520	535	8,7	D4
601 00	Hněvčeves	Smiřice	0,033	10,946	11,887	60	50	188	370	13,2	C2
620 00	Jaroměř	Trutnov hlavní nádraží	0,271	124,245	52,536	100	152	421	520	14,9	C2
621 00	Trutnov hlavní nádraží	Chlumeck nad Cidlinou	124,245	23,125	102,892	100	90	275/ 342	414/ 516	18,0	C2
622 00	Martinice v Krkonoších	Rokytnice nad Jizerou	0,286	20,400	20,649	50	30	120	120	23,0	C2/A1
623 00	Kunčice nad Labem	Vrchlabí	0,411	4,699	4,885	50	50	287	324	14,2	C3
624 00	Trutnov hl.n.	Svoboda nad Úpou	0,527	10,258	10,424	60	60	290	290	15,8	D3
625 00	Trutnov-Poříčí	Královec státní hranice	47,350	62,089	15,236	60	100	340	340	15,4	C2
627 00	Teplice nad Metují	Trutnov střed	31,689	0,188	32,594	50	45	149	397	28,3	C2
628 00	Týniště nad Orlicí	Meziměstí státní hranice	24,454	92,774	68,484	90	100	323	507	18,4	C4
629 00	Meziměstí	Otovice zastávka	1,643	14,739	14,983	60	165	450	450	12,0	C2/A1
631 00	Václavice	Starkoč	0,153	2,453	2,849	60	145	323	507	16,1	C4
632 00	Dobruška	Opočno pod Orlickými horami	0,141	5,348	5,876	50	30	154	154	15,3	A1
640 00	Veselí nad Lužnicí	Jihlava	0,533	92,804	94,192	80	167	538	650	15,3	D4
641 00	Slavonice	Kostelec u Jihlavy	36,373	0,085	54,430	50	80	248	270/ 314	18,0	C2
642 00	Střelice	Jihlava	0,314	198,301	90,167	85	185	464	571	25,0	C3/D4
643 00	Brno-Horní Heršpice	Střelice	0,117	142,499	12,631	90	185	464	571	0,0	C3

1	2	3	4	5	6	7	8	9	10	11	12
644 00	Znojmo státní hranice	Okříšky	87,660	169,019	82,367	90	160	550/ 477	579	13,4	D4
645 00	Moravské Budějovice	Jemnice	0,313	20,941	21,613	50	62	300	300	20,0	C3
660 00	Jihlava	Havlíčkův Brod	198,301	222,989	25,897	120	145	538	650	0,0	D4
661 00	Dobronín	Polná	0,326	5,933	6,410	30	100	150	150	17,9	C3
680 00	Havlíčkův Brod	Kolín	117,321	296,748	75,673	100	200	515/ 567	674	14,2	D4
681 00	Kolín	Ledečko st.1	0,514	38,259	38,828	60	40	173	490/ 320	25,1	C3
682 00	Kutná Hora hlavní nádraží	Zruč nad Sázavou	0,448	35,679	36,301	60	40	113	123	22,5	C3
683 00	Čáslav	Třemošnice	0,890	17,101	17,213	60	40	94	450/ 250	24,1	C3
684 00	Havlíčkův Brod	Humpolec	0,255	25,506	25,419	50	44	163	163	20,0	C3
700 00	Brno-Židenice	Havlíčkův Brod	0,411	117,321	117,322	140	200	515	674	18,3	D4
701 00	Tišnov	Žďár nad Sázavou	94,354	34,046	62,428	60	150	215	575	23,2	C3
702 00	Studenec	Křižanov	0,144	33,305	35,064	70	48	261	582	21,0	C3
702 90	Oslavice	Velké Meziříčí staré nádraží	20,136	22,397	2,300	40	N/A	261	261	0,0	C3
720 00	Lanžhot státní hranice	Modřice	11,395	137,767	64,465	160	220	658	720	5,4	D4
721 00	Modřice	Brno hlavní nádraží	137,767	143,769	7,557	120	220	658	720/ 356	0,0	D4
722 00	Brno H.-Heršpice-Modřické z.	Brno-Maloměřice st.6	10,054	161,472	9,384	80	600	700	720	0,0	D4
723 00	Modřice	Brno-Horní Heršpice Modřické zhl.	0,055	1,934	1,937	50	520	670	720	0,0	D4
724 00	Brno-Horní Heršpice Státní silnice	Brno-Horní Heršpice km 11,690	151,811	153,537	1,726	60	360	400	620	0,0	D4
725 00	Brno-Černovice odbočka	Brno-Černovice zhl.Táborská odbočka	2,230	1,733	0,533	60	360	450	632	8,0	D4
726 00	Hrušovany u Brna	Židlochovice	0,423	2,690	2,966	40	120	190	190	14,8	D2
728 00	Hustopeče u Brna	Šakvice	6,810	0,689	7,575	60	40	159	159	11,0	D4
729 00	Hodonín	Zaječí	36,873	0,459	37,926	50	100	140	228	15,4	C3
732 00	Břeclav státní hranice	Břeclav	77,992	82,156	4,996	120	400	660	720	2,3	D4
733 00	Břeclav	Znojmo	84,167	24,933	71,294	80	156	427	605	12,4	D4
734 00	Boří les	Lednice	0,364	9,482	9,118	50	70	111	111	14,0	C3
736 00	Střelice	Hrušovany nad Jevišovkou	142,371	93,074	50,178	80	184	361	434	13,6	C3

1	2	3	4	5	6	7	8	9	10	11	12
737 00	Moravské Bránice	Oslavany	0,377	9,485	9,703	50	96	260	260	14,6	C3
740 00	Brno-Maloměřice st.6	Česká Třebová	161,685	245,284	83,586	140	176	637	678	9,2	D4
741 00	Česká Třebová odjezdová skupina	Parník odbočka	246,625	248,977	2,407	60	135	633	700	0,0	D4
742 00	Třebovice v Čechách	Česká Třebová odjezdová skupina	7,142	0,838	7,285	60	135	658	700	0,0	D4
743 00	Česká Třebová vjezdová skupina	Parník odbočka	0,132	249,031	8,169	60	135	633	700	0,0	D4
744 00	Zádulka odbočka	Les odbočka	240,568	241,453	0,941	60	190	658	678	0,0	D4
745 00	Zádulka odbočka	Česká Třebová vjezdová skupina	240,513	1,055	1,375	60	149	637	678	0,0	D4
746 00	Třebovice v Čechách	Česká Třebová odjezdová skupina	0,017	246,625	6,837	40	149	658	700	0,0	D4
747 00	Svitavy	Žďárec u Skutče	0,442	52,286	53,319	65	55	214	370	23,6	B2/C2
748 00	Chornice	Skalice nad Svitavou	0,376	31,848	32,643	50	42	145	145	23,0	C2
749 00	Brno hlavní nádraží	Brno-Maloměřice st.6	156,029	161,526	5,496	140	176	515	674	0,0	D4
751 00	Holubice	Brno hlavní nádraží	28,320	1,351	27,764	100	160	353	395	0,0	C3
752 00	Přerov	Holubice	87,901	28,320	61,385	100	160	376	532	7,7	C3
753 00	Holubice	Blažovice	2,468	0,735	3,715	70	295	353	532	12,9	C3
754 00	Kojetín	Tovačov	0,364	10,934	11,205	50	123	156	156	15,8	C3
760 00	Prosenice	Česká Třebová	7,526 7,713	0,867	119,629	160	280	636/ 658	700	9,0	D4
761 00	Chornice	Třebovice v Čechách	40,745	76,331	35,587	50	60	177	255	14,4	C3
762 00	Kostelec na Hané	Chornice	6,952	40,745	33,794	60	70	240	245	27,1	C3
763 00	Prostějov hlavní nádraží	Kostelec na Hané	0,336	6,952	7,306	60	70	240	245	10,0	C3
764 00	Olomouc hlavní nádraží	Nezamyslice	100,855	62,545	39,992	100	130	481	533	7,4	C3
765 00	Senice na Hané	Červenka	12,224	0,525	15,560	60	40	145	170	0,0	C3
766 00	Kostelec na Hané	Senice na Hané	0,242	18,314	18,666	60	75	160	470	13,0	C3
767 00	Litovel předměstí	Mladeč	0,237	5,862	5,855	40	30	50	170	16,7	C3
768 00	Senice na Hané	Olomouc hlavní nádraží	18,314	0,021	17,881	60	75	160	470	15,2	C3
769 00	Lanškroun	Rudoltice v Čechách	4,414	0,371	4,917	50	55	145	145	21,5	C3
771 00	Zábřeh na Moravě	Šumperk	0,073	43,362	14,142	100	140	472/ 283	620	8,5	D4/C3
772 00	Bludov-Sudkov	Bludov-Chromeč	0,105	0,737	0,767	60	N/A	397	528	3,3	C3

1	2	3	4	5	6	7	8	9	10	11	12
773 00	Hanušovice	Bludov	70,734	49,345	22,204	75	110	283	360	25,0	C3
774 00	Mikulovice státní hranice	Hanušovice	51,500	0,386	51,784	60	110	374/ 283	467/ 360	32,9	C3
775 00	Lipová Lázně	Javorník ve Slezsku	0,471	5,392	31,242	60	35	114	152	29,5	C3
776 00	Velká Kraš	Vidnava	0,090	4,574	4,831	60	41	114	152	15,0	C3
777 00	Zlaté Hory	Mikulovice	8,822	0,089	9,085	40	43	203	203	25,6	C3
778 00	Šumperk	Olomouc hlavní nádraží	43,362	102,062	58,070	90	80	283/ 207	360/ 560	17,9	C3/D4
780 00	Bohumín	Prosenice	276,998	190,273	86,870	160	350	636	720	9,0	D4
781 00	Suchdol nad Odrou	Budišov nad Budišovkou	0,487	39,244	39,358	60	70	175/ 130	250/ 130	28,3	C3
782 00	Suchdol nad Odrou	Fulnek	0,228	9,740	10,145	60	30	180	180	24,1	C3
783 00	Suchdol nad Odrou	Nový Jičín město	0,000	8,348	8,364	40	60	260	260	22,9	C3
784 00	Studénka	Bílovec	0,193	7,591	8,020	50	40	75	190	22,7	C3
785 00	Studénka	Sedlnice	1,586	6,595	7,123	100	170	395	484	0,0	D4
786 00	Sedlnice	Mošnov,Ostrava Airport	0,066 0,034	2,903	2,837	90	178	N/A	N/A	13,00	D4
787 00	Sedlnice	Veřovice	6,595	26,191	19,123	80	75	395/ 181	484/ 181	28,4	C3
791 00	Odra odbočka	Ostrava-Svinov	0,305	2,684	4,025	80	350	700	700	13,3	D4
792 00	Ostrava hlavní nádraží	Vratimov	0,000	10,768	11,044	100	200	512/ 507	680	17,7	D4 / C3
793 00	Bohumín-Vrbice státní hranice	Bohumín-Vrbice	4,275	0,000	5,570	100	N/A	600	650	4,5	D4
794 00	Bohumín státní hranice	Bohumín	279,628	276,484	3,235	100	400	600	650	1,4	D4
795 00	Ostrava-Svinov	Opava východ	262,416	290,405	27,464	100	170	500	570/ 500	25,0	D4
796 00	Hlučín	Opava východ	14,960	289,416	23,215	70	190	400	430	14,3	C3
797 00	Chuchelná	Kravaře ve Slezsku	11,326	21,349	10,555	50	120	250	250	15,0	C3
800 00	Přerov	Břeclav	180,958	85,673	95,509	160	284	636	720	4,7	D4
801 00	Hodonín	Hodonín státní hranice	0,742	3,009	3,695	60	180	680	680	9,6	D4
802 00	Rohatec	Veselí nad Moravou	0,510	0,760	20,712	80	118	221	580	0,0	B2/D4
803 00	Velká nad Veličkou státní hranice	Veselí nad Moravou	44,633	66,902	23,256	80	118	580	580	16,5	C4
804 00	Sudoměřice nad Moravou	Sudoměřice nad Moravou státní hranice	14,763	14,950	0,566	80	124	207	207	1,7	C3

1	2	3	4	5	6	7	8	9	10	11	12
805 00	Veselí nad Moravou	Blažovice	88,308	17,085	69,367	100	354	480	579	16,4	C3
806 00	Blažovice	Brno-Černovice odbočka	17,085	2,615	14,467	80	354	480	579	16,3	C3/D4
807 00	Brno-Černovice odbočka	Brno hlavní nádraží	2,615	1,280	6,782	70	354	480	579	0,0	C3
808 00	Moravský Písek	Bzenec	1,164	78,128	5,479	80	277	601	601	10,5	C3
811 00	Kunovice	Veselí nad Moravou	101,219 0,535	88,075	13,144	100	166	550	550	17,4	C3
812 00	Vlářský průmysk státní hranice	Staré Město u Uherského Hradiště	163,500	6,091	70,301	80	161	540	550	16,0	C3
813 00	Luhačovice	Újezdec u Luhačovic	9,757	0,094	10,319	50	92	83	144	12,1	C3
814 00	Zlín střed	Otrokovice	10,463	0,158	10,939	60	90	291	700	10,1	C4
815 00	Vizovice	Zlín střed	24,861	10,463	14,398	60	90	291/ 181	700/ 181	12,2	C4
816 00	Přerov	Dluhonice výhybna	184,261	186,021	4,894	160	170	658	700	0,0	D4
817 00	Prosenice	Přerov	190,273	180,958	11,221	130	350	636	720	3,0	D4
820 00	Horní Lideč státní hranice	Hranice na Moravě	21,110	0,000	70,833	90	200	538	683	18,9	D4
821 00	Valašské Meziříčí	Kojetín	60,530	0,447	61,884	80	205	256	507	0,0	C3
822 00	Zborovice	Kroměříž	16,972	0,459	17,083	60	114	127	134	13,0	C2/B2
823 00	Vratimov	Valašské Meziříčí	10,768	61,600	62,353	80	170	507/ 498	620/ 507	17,1	C3
824 00	Rožnov pod Radhoštěm	Valašské Meziříčí	13,193	0,160	13,929	60	85	101	210	14,9	C3
825 00	Frydlant nad Ostravicí	Ostravice	0,445	6,379	7,345	50	85	125	140	19,2	B2
826 00	Vsetín-Bečva	Velké Karlovice	2,877	27,453	24,615	50	80	94	94	21,0	B2
827 00	Bylnice	Horní Lideč	0,541	18,642	19,895	70	163	410	550	17,0	C3
840 00	Opava východ	Olomouc hlavní nádraží	115,507	0,440	117,627	75	150	421	497	20,1	C3
841 00	Valšov	Rýmařov	0,300	14,352	15,160	50	40	200	200	13,2	D4
842 00	Bruntál	Malá Morávka	0,161	17,266	17,851	50	40	180	180	43,1	C3/A1
843 00	Milotice nad Opavou	Vrbno pod Pradědem	0,177	20,652	20,091	50	N/A	N/A	N/A	20,0	C3
844 00	Krnov	Jindřichov ve Slezsku státní hranice	87,799	25,694	26,562	80	80	374	467	12,2	C3
845 00	Osoblaha	Třemešná ve Slezsku	20,344	14,978	20,567	40	35	80	80	27,3	N/A
846 00	Opava východ	Hradec nad Moravicí	0,790	8,090	8,179	60	90	200	200	18,7	C3
847 00	Moravice odbočka	Svobodné Heřmanice	2,726	25,309	22,574	50	40	90	90	32,3	C3
860 00	Dětmorovice	Bohumín	285,243	276,998	10,961	140	350	654	700	3,0	D4

1	2	3	4	5	6	7	8	9	10	11	12
861 00	Petrovice u Karviné státní hranice	Dětmarovice	292,602	285,122	7,480	120	250	650/ 654	700	4,8	D4
862 00	Karviná město	Petrovice u Karviné	5,280	0,480	5,236	50	N/A	500	500	21,3	C4
880 00	Chotěbuz	Dětmarovice	323,626	339,622	15,983	100	300	654	700	5,0	D4
881 00	Koukolná odbočka	Závada odbočka	0,087	1,206	1,250	60	-	700	700	3,6	D4
882 00	Český Těšín	Ostrava-Kunčice	0,757 4,419	28,355	33,366	100	350	657	700	8,0	D4
883 00	Ostrava-Kunčice	Polanka nad Odrou výhybna	31,074	38,987	9,487	100	350	657	700	8,0	D4
884 00	Mosty u Jablunkova státní hranice	Chotěbuz	286,534	323,626	38,547	160	300	650/ 654	700	16,0	D4
885 00	Český Těšín	Frydek-Místek	136,756	111,796	27,172	70	80	212	250/ 620	18,1	C3
886 00	Český Těšín státní hranice	Český Těšín	139,112	138,798	0,335	40	80	650/ 220	650/ 220	7,4	C2

Table B

TSI category in accordance to Commission Regulation (EU) No 1299/2014 of 18 November 2014 on the technical specifications for interoperability relating to the 'infrastructure' subsystem of the rail system in the European Union

Meaning of individual columns and symbols used:

- Column number:
- 1 – number of line
 - 2 – name of the railway line beginning
 - 3 – name of the railway line end
 - 4 – kilometre position of the railway line beginning
 - 5 – kilometre position of the railway line end
 - 6 – target category in accordance to TSI INF – passenger
 - 7 – target category in accordance to TSI INF – freight
 - 8 – main or global network in passenger transport
 - 9 – main or global network in freight transport
 - 10 - line category in accordance to Rail Act:
 - a) C – nationwide line
 - b) R – regional line

Track category TSI according to Commission Regulation (EU) No. 1299/2014 of 18 November 2014 on technical specifications for the interoperability of the infrastructure subsystem of the railway system in the European Union and track category

1	2	3	4	5	6	7	8	9	10
100 00	Plzeň hlavní nádraží	Cheb	350,123	456,007	P5	F1	H	H	C
101 00	Aš	Hranice v Čechách	27,285	15,898	P6	F4			R
102 00	Františkovy Lázně	Aš státní hranice	7,213	29,585	P6	F4			R
103 00	Cheb	Vojtanov státní hranice	73,615	51,325	P6	F4			C
104 00	Cheb	Cheb státní hranice	150,539	140,587	P5	F1	H	H	C
105 00	Mariánské Lázně	Karlovy Vary	0,389	2,617	P6	F4			R
106 00	Domažlice odbočná výh.č.401	Planá u Mariánských Lázní	5,842	0,027	P6	F4			R
107 00	Svojsín	Bor	0,132	14,904	P6	F4			R

1	2	3	4	5	6	7	8	9	10
108 00	Přovany	Bezručice	0,376	24,087	P6	F4			R
120 00	Chomutov	Cheb	126,192	236,297	P5	F2	G	G	C
121 00	Tršnice	Františkovy Lázně	0,402	3,724	P6	F4			R
122 00	Tršnice	Luby u Chebu	0,509	20,955	P6	F4			R
123 00	Sokolov os.n.	Kraslice st.hr.	0,574	27,452	P6	F4			R
124 00	Krásný Jez	Nové Sedlo u Lokte	0,203	18,083	P6	F4			R
125 00	Chodov	Nová Role	0,418	6,263	P6	F4			R
126 00	Karlovy Vary-Sedlec	Potůčky státní hranice	5,221	46,199	P6	F4			R
127 00	Dalovice	Merklín	10,325	0,040	P6	F4			R
128 00	Kadaň-Předměstí	Kadaň-Prunéřov	26,404	32,376	P6	F4			R
129 00	Kaštice	Kadaň-Předměstí	0,038	26,404	P6	F4			R
131 00	Kadaňský Rohozec	Vilémov u Kadaně	8,825	17,779	P6	F4			R
132 00	Chomutov	Vejprty státní hranice	0,708	35,391	P6	F4			R
133 00	Droužkovice	Dubina odbočka	1,075	5,707		F4			C
140 00	Most	Chomutov	48,681	65,712	P5	F2	G	G	C
141 00	Chomutov město	Chomutov seř.n.	0,118	2,551		F2			C
142 00	Březno u Chomutova	Chomutov	116,223	124,294	P5	F3			C
143 00	Dolní Rybník odbočka	Jirkov	0,038	1,874	P6	F4			R
144 00	Třebošice	Most nové nádraží	1,603	3,955		F2			C
145 00	Most	Most nové nádraží	47,228	4,458		F2			C
146 00	Most nové nádraží	Louka u Litvínova	4,458	11,686	P6	F4			R
147 00	Louka u Litvínova	Litvínov	53,952	55,683	P6	F4			R
148 00	Louka u Litvínova	Moldava v Krušných horách	132,920	158,081	P6	F4			R
149 00	Louny	Most	95,228	121,101	P6	F4			R
160 00	Ústí nad Labem hlavní nádraží	Most	0,507	48,681	P5	F2	G	G	C
161 00	České Zlatníky odbočka	Obrnice	234,800	233,182		F3			C
162 00	Oldřichov u Duchcova	Louka u Litvínova	42,781	53,064	P6	F4			R
164 00	Děčín hl.n.	Oldřichov u Duchcova	0,191	39,443		F4			R
165 00	Ústí nad Labem západ	Bílina	4,831	25,339	P6	F3	G	G	C
166 00	Řetenice	Lovosice	0,589	35,747	P6	F4			R
168 00	Ústí nad Labem západ St. 5	Ústí nad Labem západ vhb. 852	0,063	2,074		F2		G	C

1	2	3	4	5	6	7	8	9	10
169 00	Ústí nad Labem hlavní nádraží jih	Ústí nad Labem západ	0,082	0,978		F2		G	C
180 00	Plzeň hlavní nádraží	Žatec	1,070	203,390	P5	F3			C
181 00	Rakovník	Bečov nad Teplou	0,650	87,262	P6	F4			R
182 00	Protivec	Bochov	0,200	16,823		F4			R
183 00	Rakovník	Mladotice	1,354	38,558	P6	F4			R
184 00	Žatec západ	Žatec-Velichov	0,000	1,062		F4			C
185 00	Žatec	Březno u Chomutova	101,978	116,223	P5	F3			C
186 00	Lužná u Rakovníka	Žatec	61,709	101,978	P6	F4			R
187 00	Žatec	Obrnice	204,167	232,107	P5	F3			C
188 00	Louny	Postoloprty	10,675	0,265	P6	F4			R
189 00	Odb. Bažantnice	Odb. Vrbka	0,795	216,408		F4			R
191 00	Louny předměstí	Rakovník	44,765 0,308	0,650	P6	F4			R
192 00	Krupá	Kolešovice	0,198	12,218					R
200 00	Plzeň hlavní nádraží	Česká Kubice státní hranice	104,526	184,102	P5	F1	H	H	C
201 00	Staňkov	Poběžovice	0,165	19,076	P6	F4			R
202 00	Janovice nad Úhlavou	Domažlice	0,727	30,875	P6	F4			R
203 00	Nýřany	Heřmanova Huť	0,112	9,669	P6	F4			R
204 00	Klatovy	Železná Ruda-Alžbětín	48,334	0,000	P6	F4			R
205 00	Plzeň hlavní nádraží	Klatovy	97,040	48,334	P5	F4			C
220 00	Nemanice	Plzeň hlavní nádraží	216,875 0,042	347,321	P5	F2	G	G	C
221 00	Nepomuk	Blatná	24,230	0,229	P6	F4			R
222 00	Horažďovice předměstí	Klatovy	0,292	58,071	P6	F4			R
223 00	Strakonice	Volary	0,328	70,364	P6	F4			R
224 00	Březnice	Strakonice	0,234	49,093	P6	F4			R
225 00	Putim	Ražice	0,246	2,624	P6	F4			R
226 00	Číčenice	Volary	0,455	56,290	P6	F4			R
227 00	Číčenice	Týn nad Vltavou	0,629	21,582		F4			R
228 00	Dívčice	Netolice	0,471	13,785		F4			R
240 00	Horní Dvořiště státní hranice	České Budějovice	61,097	117,983	P5	F2	G	G	C

1	2	3	4	5	6	7	8	9	10
241 00	Volary	České Budějovice, odbočná výh.č.502	56,290	0,000	P6	F4			R
242 00	Černý Kříž	Nové Údolí	62,111	69,981	P6	F4			R
243 00	Rybník	Lipno nad Vltavou	0,167	22,185	P6	F4			R
260 00	České Velenice státní hranice	České Budějovice	163,100	211,641	P5	F3	G	G	C
261 00	České Velenice	Veselí nad Lužnicí	1,157	54,506	P5	F3			C
280 00	České Budějovice	Benešov u Prahy	117,983	133,570	P3	F2	G	G	C
281 00	Tábor	Bechyně	0,010	24,303	P6	F4			R
282 00	Tábor	Písek	1,750	59,460	P6	F4			R
283 00	Horní Cerekev	Tábor	0,451	69,093	P6	F4			R
284 00	Olbramovice	Sedlčany	0,286	16,825	P6	F4			R
285 00	Trhový Štěpánov	Benešov u Prahy	33,645	0,849	P6	F4			R
300 00	Benešov u Prahy	Praha-Uhřetěves	133,570	170,492	P3	F2	G	G	C
301 00	Praha-Uhřetěves	Praha-Zahradní Město	170,492	178,095	P5	F1	G	H	C
302 00	Praha-Zahradní Město	Praha-Vršovice	178,095	183,630	P5	F4	G	G	C
303 00	Čerčany	Praha-Krč	0,470	6,393	P6	F4			R
304 00	Dobříš	Skochovice odbočka	0,666	29,580	P6	F4			R
305 00	Světlá nad Sázavou	Čerčany	47,618	65,347	P6	F4			R
320 00	Praha-Libeň	Praha hlavní nádraží	0,933	3,859	P3		H		C
321 00	Praha-Libeň	Praha-Holešovice Stromovka	0,199	5,071	P5	F1	G	G	C
322 00	Praha Masarykovo nádraží-Hrabovka	Praha Masarykovo n.-Viadukt	0,006	0,595	P6		H	G	C
323 00	Balabenka odbočka	Praha Masarykovo nádraží-Sluncová	0,066 0,066	1,964 1,345	P5		H		C
324 00	Praha-Libeň	Praha Masarykovo nádraží	406,236 405,870	409,899	P5		H	G	C
325 00	Balabenka odbočka	Praha-Holešovice Rokytka	0,066 0,320	0,889 0,845	P5		G		C
326 00	Praha-Vršovice	Praha hlavní nádraží	182,5	185,369	P5		H		C
327 00	Praha hlavní nádraží	Balabenka odbočka	185,314	4,816	P5		H		C
328 00	Praha-Libeň	Praha-Vysočany	0,111	1,588		F1		H	C
329 00	Praha-Malešice	Praha-Zahradní Město	4,963	178,137	P5	F1	H	H	C
332 00	Praha-Běchovice	Praha-Malešice	0,731	4,963	P5	F1	H	G	C
333 00	Praha-Libeň	Praha-Malešice	1,508	3,821		F1		H	C

1	2	3	4	5	6	7	8	9	10
334 00	Praha-Hostivař	Praha-Malešice	0,514	3,242		F1		H	C
335 00	Praha-Vršovice	Praha-Vyšehrad výhybna	0,636	1,437		F4		G	C
336 00	Praha-Vršovice	DKV Praha PP Praha jih	182,454	0,852	P6				C
337 00	Praha-Krč	Praha-Vršovice	4,514	0,733	P5	F4	G	G	C
340 00	Praha-Radotín	Beroun	10,237	39,210	P3	F1	H	H	C
341 00	Rakovník	Beroun	41,881	0,042	P6	F4			R
342 00	Praha-Smíchov	Beroun-Závodí	1,139	1,704	P6	F4			R
343 00	Praha-Smíchov severní zhlaví	Hostivice	2,985	19,212	P6	F3			C
344 00	Rudná u Prahy	Jeneček odbočka	16,118	0,069	P6	F4			R
345 00	Jeneček odbočka	Podlešín	0,068	47,520		F3			C
346 00	Jeneček vhb.č.5	Jeneček vhb.č.6	22,598	23,410		F4			R
347 00	Praha-Smíchov	Praha-Radotín	0,180	10,237	P3	F3	G	G	C
348 00	Praha-Zahradní Město	Odbočka Závodiště	7,766	14,492 14,448		F1	G	H	C
349 00	Praha hlavní nádraží	Praha-Smíchov	0,431	4,313	P5		H	G	C
360 00	Beroun	Plzeň hlavní nádraží	39,527	104,526	P3	F1	H	H	C
361 00	Ejovice	Radnice	5,249	6,809	P6	F4			R
362 00	Rokycany	Nezvěstice	0,027	26,589	P6	F4			R
363 00	Zdice	Protivín	101,354	0,022	P5	F4			C
364 00	Rožmitál p. Třemšínem	Březnice	0,000	6,906	P6	F4			R
365 00	Zadní Třebaň	Lochovice	0,076	26,350	P6	F4			R
380 00	Praha-Holešovice Stromovka	Kralupy nad Vltavou	413,53	437,961	P5	F1	G	G	C
381 00	Praha-Bubny	Praha-Holešovice Stromovka	412,924	413,530	P5		G	G	C
382 00	Praha Masarykovo nádraží	Praha-Bubny	409,995	412,924	P5		H	G	C
383 00	Praha-Bubny	Kladno	0,672	28,626	P5	F3	H		C
384 00	Kladno	Lužná u Rakovníka	28,626	61,709	P5	F3			C
385 00	Lužná u Rakovníka	Rakovník	0,315	42,971	P5	F3			C
386 00	Kladno	Kralupy nad Vltavou	0,620	437,167	P6	F4			C
400 00	Kralupy nad Vltavou	Lovosice	437,961	492,992	P3	F1	G	G	C
401 00	Kralupy nad Vltavou	Louny	0,883	95,228	P6	F4			R
402 00	Kralupy nad Vltavou předměstí	Velvary	2,753	10,002	P6	F4			R

1	2	3	4	5	6	7	8	9	10
403 00	Vraňany	Lužec nad Vltavou	0,239	3,397	P6	F4			R
404 00	Roudnice nad Labem	Straškov	1,484	13,270	P6	F4			R
405 00	Vraňany	Libochovice	36,975	0,345	P6	F4			R
406 00	Straškov	Zlonice	14,881	32,173	P6	F4			R
407 00	Lovosice	Louny	0,614	0,675	P6	F4			R
420 00	Lovosice	Děčín hlavní nádraží	492,992	540,164	P5	F1	G	G	C
421 00	Děčín hlavní nádraží	Děčín státní hranice	1,026	11,859	P5	F1	H	H	C
422 00	Děčín východ dolní nádraží	Děčín-Prostřední Žleb	457,725	458,961		F1	H	G	C
423 00	Děčín hlavní nádraží	Děčín východ dolní nádraží	1,792	456,065	P5	F3	G	H	C
440 00	Nymburk hlavní nádraží	Ústí nad Labem-Střekov	323,297	431,472	P5	F1	G	H	C
441 00	Ústí nad Labem-Střekov	Děčín východ	431,472	457,725	P5	F1	G	H	C
442 00	Ústí nad Labem-Střekov	Ústí nad Labem západ	0,363	3,0161,461	P5	F2	G	G	C
443 00	Žalhostice	Velké Žernoseky	0,051	0,785		F4			R
444 00	Mělník	Mladá Boleslav hlavní nádraží	0,498	14,623	P6	F4			R
445 00	Lysá nad Labem	Milovice	0,633	5,800	P6	F4			R
446 00	Lysá nad Labem	Praha-Vysočany	0,863	6,168	P3	F1	G	H	C
447 00	Čelákovice	Mochov	8,785	4,014		F4			R
460 00	Česká Lípa hlavní nádraží	Liberec	0,692	143,166	P5	F4			C
461 00	Lovosice	Česká Lípa hlavní nádraží	36,931	84,564	P6	F4			R
462 00	Benešov nad Ploučnicí	Česká Lípa hlavní nádraží	0,055	19,853	P5	F3			C
463 00	Děčín východ	Benešov nad Ploučnicí	3,983	12,065	P5	F3			C
464 00	Benešov nad Ploučnicí	Jedlová	12,065	40,115	P6	F4			R
465 00	Česká Lípa hlavní nádraží	Rumburk	45,456	91,277	P5	F3			C
466 00	Rumburk	Rumburk státní hranice	91,277	97,690		F4			C
467 00	Mikulášovice dolní nádraží	Rumburk	0,068	17,783	P6	F4			R
468 00	Rumburk	Dolní Poustevna státní hranice	0,020	26,271	P6	F4			R
469 00	Panský	Krásná Lípa	0,200	5,017	P6	F4			R
471 00	Rybniště	Varnsdorf státní hranice	0,078	11,459	P6	F4			R
472 00	Varnsdorf	Varnsdorf staré nádraží státní hranice	10,361	13,706	P6	F4			R
473 00	Srní u České Lípy	Žizníkov výhybna	0,520	3,474	P6	F4			R

1	2	3	4	5	6	7	8	9	10
474 00	Mimoň	Mimoň staré nádraží	0,027	3,054		F4			C
480 00	Skály odbočka	Turnov	12,425	103,654	P5	F3			C
481 00	Balabenka odbočka	Praha-Vysočany	4,816	6,168	P3		G		C
482 00	Kralupy nad Vltavou	Neratovice	1,381	17,174	P6	F4			C
483 00	Čelákovice	Neratovice	0,126	15,098	P6	F4			R
484 00	Nymburk hlavní nádraží	Mladá Boleslav hlavní nádraží	0,562	29,359	P5	F2			C
485 00	Mladá Boleslav hlavní nádraží	Mladá Boleslav město	14,687	21,195	P6	F2			C
486 00	Mladá Boleslav město	Stará Paka	21,195	73,248	P6	F4			R
487 00	Bakov nad Jizerou	Česká Lípa hlavní nádraží	0,625	45,445	P5	F3			C
488 00	Bakov nad Jizerou-Zálučí odbočka	Dolní Bousov	37,380	22,836	P6	F4			R
491 00	Hradec Králové hlavní nádraží	Turnov	0,638	29,014	P6	F4			R
492 00	Jičín	Nymburk město	41,433	0,499	P6	F4			R
500 00	Jaroměř	Liberec	40,363	160,972	P5	F3			C
501 00	Liberec	Hrádek nad Nisou státní hranice	0,750	21,769	P5	F4			C
502 00	Liberec	Frýdlant v Čechách státní hranice	160,934	200,107	P5	F3			C
503 00	Frýdlant v Čechách	Jindřichovice pod Smrkem	0,586	23,671	P6	F4			R
504 00	Bílý Potok pod Smrkem	Raspenava	6,365	0,328	P6	F4			R
505 00	Liberec	Tanvald	1,786	27,534	P6	F4			R
506 00	Smržovka	Josefův Důl	0,232	6,776	P6	F4			R
507 00	Tanvald	Harrachov státní hranice	27,534	40,111	P6	F4			R
508 00	Železný Brod	Tanvald	0,148	16,824	P6	F4			R
520 00	Kolín	Praha-Libeň	344,491	406,236	P3	F1	H	G	C
521 00	Nymburk hlavní nádraží	Poříčany	1,332	1,141	P5	F2			C
522 00	Pečky	Kouřim	0,664	3,001	P6	F4			R
523 00	Bošice	Bečváry	12,986	3,820					R
524 00	Praha-Běchovice Blatov	Praha-Běchovice	0,074 0,156	1,512 1,560	P3	F1	H	G	C
540 00	Česká Třebová	Kolín	245,284	344,491	P3	F1	H	H	C
541 00	Prachovice	Přelouč	21,556	1,800	P6	F4			R
542 00	Heřmanův Městec	Borohrádek	0,305	46,769	P6	F4			R
543 00	Chrudim	Chrudim město	0,622	1,114	P6	F4			R

1	2	3	4	5	6	7	8	9	10
544 00	Choceň	Litomyšl	0,969	23,807	P6	F4			R
545 00	Letohrad	Ústí nad Orlicí	0,346	13,320	P5	F3	G	G	C
546 00	Lichkov státní hranice	Letohrad	113,251	89,659	P5	F3	G	G	C
547 00	Letohrad	Týniště nad Orlicí	89,659	50,296	P5	F3			C
548 00	Častolovice	Solnice	0,717	15,613	P6	F4			R
549 00	Doudleby nad Orlicí	Rokytnice v Orlických horách	0,450	19,694	P6	F4			R
551 00	Hanušovice	Lichkov	70,734	94,245	P6	F4			R
552 00	Štítý	Dolní Lipka	16,636	0,211	P6	F4			R
553 00	Hanušovice-Morava	Staré Město pod Sněžníkem	1,892	11,447	P6	F4			R
560 00	Kolín	Nymburk hlavní nádraží	298,487	323,297	P3	F1	G	H	C
561 00	Babín odbočka	Nymburk hlavní nádraží	0,092 0,054	4,114		F1		H	C
562 00	Choceň	Velký Osek	0,949	0,346	P3	F1			C
563 00	Chlumeck nad Cidlinou	Obora odbočka	0,722	0,046	P6	F4			R
564 00	Kolín-Hradištko	Prům.zóna TPCA	0,043	1,438		F3			R
580 00	Pardubice hlavní nádraží	Hradec Králové hlavní nádraží	1,337	21,835	P3	F1			C
581 00	Opatovice nad Labem-Pohřebačka	Plačice odbočka	0,864	3,619		F2			C
582 00	Havlíčkův Brod	Pardubice-Rosice nad Labem	0,538	91,692	P5	F4			C
600 00	Hradec Králové hlavní nádraží	Jaroměř	23,144	40,363	P3	F3			C
601 00	Hněvčeves	Smiřice	0,033	10,946					R
620 00	Jaroměř	Trutnov hlavní nádraží	0,271	124,245	P5	F3			C
621 00	Trutnov hlavní nádraží	Chlumeck nad Cidlinou	124,245	23,125	P5	F3			C
622 00	Martinice v Krkonoších	Rokytnice nad Jizerou	0,286	20,400	P6	F4			R
623 00	Kunčice nad Labem	Vrchlabí	0,411	4,699	P6	F4			R
624 00	Trutnov hl.n.	Svoboda nad Úpou	0,527	10,258	P6	F4			R
625 00	Trutnov-Poříčí	Královec státní hranice	47,350	62,089	P6	F4			R
626 00	Královec	Žacléř	0,000	5,092		F4			R
627 00	Teplice nad Metují	Trutnov střed	31,689	0,188	P6	F4			R
628 00	Týniště nad Orlicí	Meziměstí státní hranice	24,454	92,774	P5	F3			C
629 00	Meziměstí	Otovice zastávka	1,643	14,739	P6	F4			R
631 00	Václavice	Starkoč	0,153	2,453	P5	F3			R

1	2	3	4	5	6	7	8	9	10
632 00	Dobruška	Opočno pod Orlickými horami	0,141	5,348	P6	F4			R
640 00	Veselí nad Lužnicí	Jihlava	0,533	92,804	P5	F3			C
641 00	Slavonice	Kostelec u Jihlavy	36,373	0,085	P6	F4			R
642 00	Střelice	Jihlava	0,314	198,301	P5	F3			C
643 00	Brno-Horní Heršpice	Střelice	0,117	142,499	P5	F3			C
644 00	Znojmo státní hranice	Okříšky	87,660	169,019	P6	F4			C
645 00	Moravské Budějovice	Jemnice	0,313	20,941		F4			R
660 00	Jihlava	Havlíčkův Brod	198,301	222,989	P5	F3			C
661 00	Dobronín	Polná	0,326	5,933		F4			R
680 00	Havlíčkův Brod	Kolín	117,321	296,748	P5	F2	G	G	C
681 00	Kolín	Ledečko st.1	0,514	38,259	P6	F4			R
682 00	Kutná Hora hlavní nádraží	Zruč nad Sázavou	0,448	35,679	P6	F4			R
683 00	Čáslav	Třemošnice	0,890	17,101	P6	F4			R
684 00	Havlíčkův Brod	Humpolec	0,255	25,506	P6	F4			R
700 00	Brno-Židenice	Havlíčkův Brod	0,411	117,321	P5	F2	G	G	C
701 00	Tišnov	Žďár nad Sázavou	94,354	34,046	P6	F4			R
702 00	Studenec	Křižanov	0,144	33,305	P6	F4			R
702 90	Oslavice	Velké Meziříčí staré nádraží	20,136	22,397		F4			R
720 00	Lanžhot státní hranice	Modřice	11,395	137,767	P3	F1	H	H	C
721 00	Modřice	Brno hlavní nádraží	137,767	143,769	P3		H		C
722 00	Brno H.-Heršpice-Modřické z.	Brno-Maloměřice st.6	10,054	161,472		F1		H	C
723 00	Modřice	Brno-Horní Heršpice Modřické zhl.	0,055	1,934		F1		H	C
724 00	Brno-Horní Heršpice Státní silnice	Brno-Horní Heršpice km 11,690	151,811	153,537		F3			C
725 00	Brno-Černovice odbočka	Brno-Černovice zhl.Táborská odbočka	2,230	1,733		F2		G	C
726 00	Hrušovany u Brna	Židlochovice	0,423	2,690	P6	F4			R
728 00	Hustopeče u Brna	Šakvice	6,810	0,689	P6	F4			R
729 00	Hodonín	Zaječí	36,873	0,459	P6	F4			R
732 00	Břeclav státní hranice	Břeclav	77,992	82,156	P3	F1	H	H	C
733 00	Břeclav	Znojmo	84,167	24,933	P5	F3			R
734 00	Boří les	Lednice	0,364	9,482					R

1	2	3	4	5	6	7	8	9	10
736 00	Střelice	Hrušovany nad Jevišovkou	142,371	93,074	P6	F4			R
737 00	Moravské Bránice	Oslavany	0,377	9,485	P6	F4			R
740 00	Brno-Maloměřice st.6	Česká Třebová	161,685	245,284	P3	F1	H	H	C
741 00	Česká Třebová odjezdová skupina	Parník odbočka	246,625	248,977		F1		H	C
742 00	Třebovice v Čechách	Česká Třebová odjezdová skupina	7,142	0,838		F1		H	C
743 00	Česká Třebová vjezdová skupina	Parník odbočka	0,132	249,031		F1		H	C
744 00	Zádulka odbočka	Les odbočka	240,568	241,453		F1		H	C
745 00	Zádulka odbočka	Česká Třebová vjezdová skupina	240,513	1,055		F1		H	C
746 00	Třebovice v Čechách	Česká Třebová odjezdová skupina	0,017	246,625		F1		H	C
747 00	Svitavy	Žďárec u Skutče	0,442	52,286	P6	F4			R
748 00	Chornice	Skalice nad Svitavou	0,376	31,848	P6	F4			R
749 00	Brno hlavní nádraží	Brno-Maloměřice st.6	156,029	161,526	P3		H		C
751 00	Holubice	Brno hlavní nádraží	28,320	1,351	P5	F4			C
752 00	Přerov	Holubice	87,901	28,320	P3	F2	H	G	C
753 00	Holubice	Blažovice	2,468	0,735	P3	F2	H	G	C
754 00	Kojetín	Tovačov	0,364	10,934		F4			R
760 00	Prosenice	Česká Třebová	7,526 7,713	0,867	P3	F1	H	H	C
761 00	Chornice	Třebovice v Čechách	40,745	76,331	P6	F4			R
762 00	Kostelec na Hané	Chornice	6,952	40,745	P6	F4			R
763 00	Prostějov hlavní nádraží	Kostelec na Hané	0,336	6,952	P6	F4			R
764 00	Olomouc hlavní nádraží	Nezamyslice	100,855	62,545	P5	F3			C
765 00	Senice na Hané	Červenka	12,224	0,525	P6	F4			R
766 00	Kostelec na Hané	Senice na Hané	0,242	18,314	P6	F4			R
767 00	Litovel předměstí	Mladeč	0,237	5,862	P6	F4			R
768 00	Senice na Hané	Olomouc hlavní nádraží	18,314	0,021	P6	F4			R
769 00	Lanškroun	Rudoltice v Čechách	4,414	0,371	P6	F4			R
771 00	Zábřeh na Moravě	Šumperk	0,073	43,362	P5	F4			C
772 00	Bludov-Sudkov	Bludov-Chromeč	0,105	0,737	P5	F4			C
773 00	Hanušovice	Bludov	70,734	49,345	P5	F4			C
774 00	Mikulovice státní hranice	Hanušovice	51,500	0,386	P6	F4			C

1	2	3	4	5	6	7	8	9	10
775 00	Lipová Lázně	Javorník ve Slezsku	0,471	5,392	P6	F4			R
776 00	Velká Kraš	Vidnava	0,090	4,574		F4			R
777 00	Zlaté Hory	Mikulovice	8,822	0,089	P6	F4			R
778 00	Šumperk	Olomouc hlavní nádraží	43,362	102,062	P5	F4			R
780 00	Bohumín	Prosenice	276,998	190,273	P3	F1	H	H	C
781 00	Suchdol nad Odrou	Budišov nad Budišovkou	0,487	39,244	P6	F4			R
782 00	Suchdol nad Odrou	Fulnek	0,228	9,740	P6	F4			R
783 00	Suchdol nad Odrou	Nový Jičín město	0,000	8,348	P6	F4			R
784 00	Studénka	Bílovec	0,193	7,591	P6	F4			R
785 00	Studénka	Sedlnice	1,586	6,595	P5	F3			R
786 00	Sedlnice	Mošnov,Ostrava Airport	0,066 0,034	2,903	P5	F3			R
787 00	Sedlnice	Veřovice	6,595	26,191	P6	F4			R
791 00	Odra odbočka	Ostrava-Svinov	0,305	2,684	P5	F1	G	H	C
792 00	Ostrava hlavní nádraží	Vratimov	0,000	10,768	P5	F3	H	G	C
793 00	Bohumín-Vrbice státní hranice	Bohumín-Vrbice	4,275	0,000		F1		H	C
794 00	Bohumín státní hranice	Bohumín	279,628	276,484	P3	F1	H	H	C
795 00	Ostrava-Svinov	Opava východ	262,416	290,405	P5	F3			C
796 00	Hlučín	Opava východ	14,960	289,416	P6	F4			R
797 00	Chuchelná	Kravaře ve Slezsku	11,326	21,349	P6	F4			R
800 00	Přerov	Břeclav	180,958	85,673	P3	F1	G	H	C
801 00	Hodonín	Hodonín státní hranice	0,742	3,009		F4			C
802 00	Rohatec	Veselí nad Moravou	0,510	0,760	P6	F4			R
803 00	Velká nad Veličkou státní hranice	Veselí nad Moravou	44,633	66,902	P5	F4			R
804 00	Sudoměřice nad Moravou	Sudoměřice nad Moravou státní hranice	14,763	14,950		F4			R
805 00	Veselí nad Moravou	Blažovice	88,308	17,085	P5	F3			C
806 00	Blažovice	Brno-Černovice odbočka	17,085	2,615	P3	F2	H	G	C
807 00	Brno-Černovice odbočka	Brno hlavní nádraží	2,615	1,280	P3		H		C
808 00	Moravský Písek	Bzenec	1,164	78,128	P6	F4			R
811 00	Kunovice	Veselí nad Moravou	101,219 0,535	88,075	P5	F4			R
812 00	Vlářský průsmyk státní hranice	Staré Město u Uherského Hradiště	163,500	6,091	P6	F4			R

1	2	3	4	5	6	7	8	9	10
813 00	Luhačovice	Újezdec u Luhačovic	9,757	0,094	P6	F4			R
814 00	Zlín střed	Otrokovice	10,463	0,158	P5	F2			C
815 00	Vizovice	Zlín střed	24,861	10,463	P6	F4			R
816 00	Přerov	Dluhonice výhybna	184,261	186,021	P3	F1	H	H	C
817 00	Prosenice	Přerov	190,273	180,958	P3	F1	H	H	C
820 00	Horní Lideč státní hranice	Hranice na Moravě	21,110	0,000	P5	F1	G	H	C
821 00	Valašské Meziříčí	Kojetín	60,530	0,447	P6	F4			R
822 00	Zborovice	Kroměříž	16,972	0,459	P6	F4			R
823 00	Vratimov	Valašské Meziříčí	10,768	61,600	P5	F4			R
824 00	Rožnov pod Radhoštěm	Valašské Meziříčí	13,193	0,160	P6	F4			R
825 00	Frýdlant nad Ostravicí	Ostravice	0,445	6,379	P6	F4			R
826 00	Vsetín-Bečva	Velké Karlovice	2,877	27,453	P6	F4			R
827 00	Bylnice	Horní Lideč	0,541	18,642	P6	F4			R
840 00	Opava východ	Olomouc hlavní nádraží	115,507	0,440	P5	F3			C
841 00	Valšov	Rýmařov	0,300	14,352	P6	F4			R
842 00	Bruntál	Malá Morávka	0,161	17,266		F4			R
843 00	Milotice nad Opavou	Vrbno pod Pradědem	0,177	20,652	P6	F4			R
844 00	Krnov	Jindřichov ve Slezsku státní hranice	87,799	25,694	P5	F4			C
845 00	Osoblaha	Třemešná ve Slezsku	20,344	14,978					R
846 00	Opava východ	Hradec nad Moravicí	0,790	8,090	P6	F4			R
847 00	Moravice odbočka	Svobodné Heřmanice	2,726	25,309		F4			R
860 00	Dětmarovice	Bohumín	285,243	276,998	P3	F1	H	H	C
861 00	Petrovice u Karviné státní hranice	Dětmarovice	292,602	285,122	P3	F1	H	H	C
862 00	Karviná město	Petrovice u Karviné	5,280	0,480		F4			R
880 00	Chotěbuz	Dětmarovice	323,626	339,622	P3	F2	G	G	C
881 00	Koukolná odbočka	Závada odbočka	0,087	1,206		F2		G	C
882 00	Český Těšín	Ostrava-Kunčice	0,757 4,419	28,355	P5	F1	H	G	C
883 00	Ostrava-Kunčice	Polanka nad Odrou výhybna	31,074	38,987	P5	F1	G	H	C
884 00	Mosty u Jablunkova státní hranice	Chotěbuz	286,534	323,626	P3	F2	H	G	C
885 00	Český Těšín	Frýdek-Místek	136,756	111,796	P6	F4			R

1	2	3	4	5	6	7	8	9	10
886 00	Český Těšín státní hranice	Český Těšín	139,112	138,798		F1	H	G	C

Table C

Categories of railway stations and stops according to passenger access routes

- **Category 11** – stations with access to all platforms through overpass or underpass.
- **Category 12** – stations with access only to certain platforms through overpass or underpass. Some platforms are accessible via rails.
- **Category 13** – stations without overpass or underpass. Access to all platforms (except the platform next to the station building) by crossing track.
- **Category 14** – stop with access to all platforms through overpass or underpass
- **Category 15** – stop on the single track line with only one platform or stop on the double or more track line without overpass or underpass (access by crossing track or underpass in the stop neighborhood).
- **PDV** – station or stop operated by company PDV Railway, a.s.
- **PKP CI** – station or stop operated by company PKP CARGO INTERNATIONAL, a.s.

• Categories of railway stations and stops according to passenger access routes

Číslo dle SR 70	Název	Kategorie
330159	Adamov	13
330258	Adamov zastávka	14
573501	Adršpach	15
330142	Albrechtice u Českého Těšína	11
343046	Amalín	15
349175	Anenská Studánka	15
550426	Antonínov	15
730051	Aš	13
730150	Aš město	15
730259	Aš předměstí	15
330357	Babice nad Svitavou	15
350322	Babice u Šternberka	15
747956	Babylon	15

Číslo dle SR 70	Název	Kategorie
563262	Bahno	15
543611	Bakov nad Jizerou	13
543710	Bakov nad Jizerou město	15
755025	Balkova Lhota	13
348227	Bartoňov	15
563601	Bartoušov zastávka	15
330241	Baška	13
758201	Batelov	13
737924	Bavorov	15
745059	Bečov nad Teplou	13
545590	Bečov u Mostu	13
564567	Bečváry	13
330456	Bedihošť	13

Číslo dle SR 70	Název	Kategorie
757328	Bednárec	15
757427	Bednářeček	15
559518	Bechov	15
754820	Bechyně	13
754721	Bechyně zastávka	15
754424	Bechyňská Smoleč	15
755751	Bělá nad Radbuzou	13
755850	Bělá nad Radbuzou zastávka	15
568980	Bělá pod Bezdězem	13
569087	Bělá pod Bezdězem město	15
569186	Bělá pod Bezdězem zastávka	15
566307	Bělá u Staré Paky	15
566604	Bělá u Staré Paky zastávka	15

Číslo dle SR 70	Název	Kategorie
731620	Bělčice	13
767541	Běleč	15
345546	Bělotín	14
562090	Benešov nad Ploučnicí	13
551069	Benešov u Prahy	11
338723	Bernartice u Javorníka	15
573006	Bernartice u Trutnova	15
730747	Beroun	11
760843	Beroun-Závodí	13
564013	Běrunice	15
736959	Běšiny	13
731828	Bezdědovice	15
737551	Bezděkov u Klatov	15
741454	Bezděkov u Radnic	15
568899	Bezděz	13
755157	Bezdrůžice	15
344853	Bezměrov	15
754622	Bežerovice	15
567305	Bílá Třemešná	13
535401	Bílá Voda	15
549337	Bílek	15
548198	Bílina	11
548297	Bílina kyselka	15
547992	Bílina-Chudeřice	15
330647	Bílovec	15
330852	Bílovice nad Svitavou	15
575621	Bílý Kostel nad Nisou	15

Číslo dle SR 70	Název	Kategorie
548529	Bílý Potok pod Smrkem	13
342071	Biskupice u Jevíčka	15
347658	Biskupice u Luhačovic	15
348052	Bitovčice	15
754358	Blahousty	15
738021	Blanice	15
330951	Blansko	12
331157	Blansko město	15
330126	Blatec	13
747220	Blatná	13
371252	Blatnice pod Svatým Antonínkem	15
746156	Blatnice u Nýřan	15
751867	Blatno u Jesenice	13
331256	Blažovice	13
531707	Blešno	15
747659	Blížejov	13
570895	Blíževdly	13
338152	Blížkovice	15
739557	Blovce	13
330423	Bludov	13
330621	Bludov lázně	15
336347	Bocanovice (Boconowice)	15
758250	Boč	15
537605	Bohdašín	15
330720	Bohdíkov	13
544296	Bohosudov zastávka	15
533109	Bohousová	15

Číslo dle SR 70	Název	Kategorie
751123	Bohumilice v Čechách	15
751024	Bohumilice v Čechách zastávka	15
341248	Bohumín	11
740423	Bohunice	15
330928	Bohuňovice	13
539106	Bohuslavice nad Metují	13
539403	Bohuslavice nad Metují zastávka	15
331454	Bohuslavice nad Vlárí	13
331751	Bohuslavice u Kyjova	15
341669	Bohušice	15
343145	Bohušov	15
559096	Bohušovice nad Ohří	12
358457	Bohutice	15
330522	Bohutín	15
757757	Bochov	15
556167	Bojanovice	15
331850	Bojkovice	13
330050	Bojkovice město	15
556068	Bojov	15
336040	Bolatice	15
540302	Bolehošť	13
560094	Boletice nad Labem	13
553966	Bolina	15
765750	Bor	13
767558	Bor zastávka	15
364059	Borač	15
553503	Borek pod Troskami	15

Číslo dle SR 70	Název	Kategorie
756155	Borek u Tachova	15
733758	Borek u Žlutic	15
540500	Borohrádek	13
550731	Borová u Poličky	13
550038	Borová u Poličky zastávka	15
741629	Borovany	13
567008	Borovnice	15
567206	Borovnička	15
753756	Borovy	15
760926	Boršov nad Vltavou	13
367755	Bořetice	15
332155	Boří les	13
556233	Bořice	15
551994	Bořislav	15
332056	Boskovice	13
565465	Bošice	15
565663	Bošice zastávka	15
755322	Božejovice	13
332254	Božice u Znojma	13
740753	Božičany	15
546465	Brandýs nad Labem	13
546663	Brandýs nad Labem zastávka	15
546507	Brandýs nad Labem-Zápská	15
538439	Brandýs nad Orlicí	15
545467	Brandýsek	13
755728	Branice	13
335844	Branka u Opavy	15

Číslo dle SR 70	Název	Kategorie
352757	Brankovice	14
332361	Branky na Moravě	13
331124	Branná	13
332551	Bransouze	13
331223	Brantice	13
768945	Bratkovice	13
571992	Brniště	13
380154	Brno dolní nádraží	11
332957	Brno hlavní nádraží	12
333856	Brno-Černovice	15
333054	Brno-Horní Heršpice	13
340752	Brno-Chrlice	13
333153	Brno-Královo Pole	11
333351	Brno-Lesná	15
333559	Brno-Maloměřice	13
333252	Brno-Řečkovice	14
333658	Brno-Slatina	13
349761	Brno-Starý Lískovec	14
351726	Brňov	15
333955	Brno-Židenice	14
749358	Brod nad Tichou	13
331421	Brodek u Přerova	12
536102	Broumov	13
536508	Broumov-Olivětín	15
547190	Brozánky	15
564690	Brtníky	15
334052	Brumov	15

Číslo dle SR 70	Název	Kategorie
334359	Brumov střed	15
342857	Brumovice	15
331629	Bruntál	13
748459	Břasy	15
334250	Břeclav	11
339952	Břest	15
754853	Břetislav	15
542431	Břevnice	15
348656	Březí	15
543413	Březina nad Jizerou	15
562199	Březiny u Děčína	15
769349	Březnice	13
537191	Březno u Chomutova	13
559419	Březno u Mladé Boleslavi	15
549592	Březno u Postoloprť	13
334375	Březová nad Svitavou	13
334474	Březová nad Svitavou-Dlouhá	15
537506	Březová u Broumova	15
334854	Břežany	15
542076	Břežany nad Ohří	15
332320	Břidličná	15
352328	Břidličná lesy	15
332429	Břidličná zastávka	15
541177	Bříza obec	15
545699	Břvany	13
335059	Bučovice	13
544114	Buda	15

Číslo dle SR 70	Název	Kategorie
561860	Budčice	15
330845	Budišov nad Budišovkou	15
367250	Budišov u Třebíče	15
351155	Budkovice	0
541979	Budyně nad Ohří	15
752527	Bujanov	15
560318	Bukovno	15
555102	Butoves	13
563361	Bykáň	15
556035	Bylany	15
335356	Bylnice	13
352922	Bystrovany	15
551192	Bystřany v Čechách	15
331041	Bystřice (Bystrzyca)	11
335554	Bystřice nad Pernštejnem	13
335851	Bystřice pod Hostýnem	13
551168	Bystřice u Benešova	15
338525	Bystřička	14
545517	Byšice	13
336156	Bzenec	13
361758	Bzenec přívoz	13
334755	Bzenec-Olišovec	15
754655	Cebiv	15
556209	Cerekvice nad Bystřicí	15
552539	Cerekvice nad Loučnou	15
552638	Cerekvice nad Loučnou zastávka	15
531665	Cerhenice	14

Číslo dle SR 70	Název	Kategorie
731448	Cerhovice	14
362954	Cetkovice	15
558403	Cidlina	15
745554	Cihelny	15
540344	Církvice	15
759050	Citice	13
536870	Cítoliby	15
369652	Citonice	15
543363	Cítov	15
542373	Ctiněves	15
550335	Čachnov	13
562314	Čachovice	13
540443	Čáslav	13
580001	Čáslav místní nádraží	13
532002	Častolovice	13
532200	Častolovice zastávka	15
364158	Čebín	14
336354	Čejč	13
734327	Čejetice	13
752667	Čejkovice	15
333641	Čeladná	15
547760	Čelákovice	11
547562	Čelákovice zastávka	15
547752	Čelákovice-Jiřina	14
330555	Čelčice	15
332924	Čelechovice na Hané	15
754127	Čenkov u Malšic	15

Číslo dle SR 70	Název	Kategorie
569004	Čeperka	14
550467	Čerčany	12
540708	Čermná nad Orlicí	13
350140	Čermná ve Slezsku	15
759225	Černá v Pošumaví	13
539205	Černčice	15
562967	Černíný	15
532663	Černošice	14
532465	Černošice-Mokropsy	14
337428	Černotín	15
547521	Černousy	15
534990	Černovice u Chomutova	15
534404	Černovír	15
568105	Černožice	15
537969	Černuc	15
760827	Černý Dub	15
739326	Černý Kříž	13
747824	Čertova Stěna	15
756023	Červená nad Vltavou	13
535203	Červená Voda	15
535252	Červená Voda-Pod rozhlednou	15
565168	Červené Pečky	15
753855	Červené Poříčí	15
333120	Červenka	12
343251	Červenka zastávka	15
574509	Červený Kostelec	13
534800	Červený Potok	15

Číslo dle SR 70	Název	Kategorie
552463	Červený Újezd u Votic zastávka	14
346650	Česká	15
562991	Česká Kamenice	13
748053	Česká Kubice	13
568097	Česká Lípa hlavní nádraží	11
568295	Česká Lípa střelnice	15
561993	Česká Lípa-Holý vrch	15
537803	Česká Metuje	15
575001	Česká Skalice	13
539130	Česká Třebová	11
345728	Česká Ves	15
345926	Česká Ves bazén	15
732826	České Budějovice	11
753624	České Budějovice jižní zastávka	15
734525	České Budějovice severní zastávka	14
539098	České Hamry	15
736322	České Velenice	11
530667	Český Brod	11
760025	Český Krumlov	13
560466	Český Šternberk	15
560565	Český Šternberk zastávka	15
332346	Český Těšín	11
532101	Čestice	15
733527	Čičenice	13
332858	Číchov	15
730424	Čimelice	13
563916	Činěves	15

Číslo dle SR 70	Název	Kategorie
555961	Čisovice	13
762245	Čistá	15
554295	Čížkovice	13
561167	Čížov	15
730820	Čížová	13
750927	Čkyně	15
554162	Čtyřkoly	15
357855	Čunín	15
748822	Dačice	13
748723	Dačice město	15
734459	Dalovice	13
759258	Dasnice	13
556969	Davle	13
757021	Děbolín	15
556597	Děčín hlavní nádraží	11
556894	Děčín východ	13
586891	Děčín východ dolní nádraží	13
557090	Děčín zastávka	15
543199	Děčín-Bynov	15
556191	Děčín-Čertova Voda	15
543298	Děčín-Oldřichov	15
556092	Děčín-Prostřední Žleb	13
556290	Děčín-Přípeř	15
560193	Děčín-Staré Město	15
350157	Dědice	15
537902	Dědov	15
754051	Dehtín	15

Číslo dle SR 70	Název	Kategorie
332643	Děhylov	13
537597	Denětice	15
549725	Desná	15
549741	Desná-Pustinská	15
549733	Desná-Riedlova Vila	15
769653	Dešenice	15
533679	Deštnice	15
332742	Dětmarovice	11
333229	Dětřichov nad Bystřicí	13
349043	Dívčí Hrad	15
733329	Dívčice	13
331553	Divnice	15
559617	Dlouhá Lhota	15
539239	Dlouhá Třebová	11
556704	Dlouhé Dvory	15
557397	Dobkovice	14
552299	Dobkovičky	15
739227	Dobrá na Šumavě	15
332841	Dobrá u Frýdku-Mítku	13
730143	Dobrá Voda u Březnice	15
555904	Dobrá Voda u Hořic	15
742221	Dobrá Voda u Pelhřimova	13
332940	Dobratice pod Prašivou	15
354357	Dobré Pole	15
545897	Dobroměřice	15
743328	Dobronice u Chýnova	15
336552	Dobronín	13

Číslo dle SR 70	Název	Kategorie
336651	Dobronín zastávka	15
338657	Dobrotice	15
561910	Dobrovice	13
540567	Dobrovíz	15
540617	Dobrovíz-Amazon	15
540104	Dobruška	15
540203	Dobruška-Pulice	15
753251	Dobřany	13
769356	Dobřany zastávka	15
530808	Dobřenice	13
532978	Dobříčany	15
553164	Dobříčkov	15
532267	Dobřichovice	12
738153	Dobříkov na Šumavě	15
537134	Dobříkov u Chocně	15
542670	Dobříň	15
556464	Dobříš	13
530113	Dobšice nad Cidlinou	13
556506	Dohalice	15
568592	Doksy	13
565622	Dolánky	15
544460	Dolany nad Vltavou	14
549295	Dolejší Hůrky	15
348854	Dolenice	15
542738	Dolík	15
333047	Dolní Benešov	15
337949	Dolní Benešov-Zábřeh	15

Číslo dle SR 70	Název	Kategorie
543066	Dolní Beřkovice	12
748426	Dolní Bolíkov	15
559112	Dolní Bousov	13
541730	Dolní Březinka	15
555565	Dolní Břežany-Jarov	15
758300	Dolní Cerekev	15
533604	Dolní Dobrouč	15
562892	Dolní Habartice	15
747451	Dolní Kamenice	15
564799	Dolní Křečany	15
331058	Dolní Lhota	15
533901	Dolní Libchavy	15
534602	Dolní Lipka	13
364257	Dolní Loučky	15
767350	Dolní Luby	15
341347	Dolní Lutyně	15
535104	Dolní Orlice	15
730622	Dolní Ostrovec	15
566992	Dolní Podluží	15
549626	Dolní Polubný	15
761429	Dolní Poříčí	15
565291	Dolní Poustevna	15
332759	Dolní Smrčné	15
740951	Dolní Stupno	15
558296	Dolní Zálezly	14
749853	Dolní Žandov	11
340745	Dolní Životice	15

Číslo dle SR 70	Název	Kategorie
556399	Dolní Žleb	11
556498	Dolní Žleb zastávka	15
330654	Doloplazy	15
756353	Doly	15
732628	Domanice	15
553461	Domašín	15
334227	Domašov nad Bystřicí	13
735159	Domažlice	13
735258	Domažlice město	15
538298	Domina	15
770123	Domoradice	15
550194	Domoušice	13
756726	Doňov	13
745752	Doubí u Karlových Varů	15
735928	Doubí u Tábora	15
543124	Doubí u Turnova	15
359950	Doubřavice nad Svitavou	15
352252	Doubřavník	15
532606	Doudleby nad Orlicí	13
334524	Drahanovice	15
564666	Drahobudice	15
334722	Drahotuše	12
537183	Droužkovice	11
545566	Dřetovice	15
530246	Dřísy	13
554592	Dubany	15
756056	Dubec	15

Číslo dle SR 70	Název	Kategorie
542092	Dubí	15
570697	Dubičná	15
737759	Dubová Lhota	15
533398	Duchcov	14
758508	Dvorce	15
736520	Dvory nad Lužnicí	15
538330	Dvořisko	15
567404	Dvůr Králové nad Labem	13
338350	Dyje	15
563817	Dymokury	15
745315	Dynín zastávka	15
742338	Dýšina	15
732354	Dýšina-Horomyšlice	15
337154	Dzbel	15
552935	Džbánov	15
732255	Ejovice	11
547620	Filipovka	15
737429	Frahelž	15
562397	Františkov nad Ploučnicí	13
740050	Františkovy Lázně	13
740100	Františkovy Lázně-Aquaforum	15
333344	Frenštát pod Radhoštěm	13
333245	Frenštát pod Radhoštěm město	15
333443	Frýdek-Místek	11
333542	Frýdlant nad Ostravicí	11
333849	Frýdlant nad Ostravicí zastávka	15
333740	Frýdlant nad Ostravicí-Nová Dědina	15

Číslo dle SR 70	Název	Kategorie
546523	Frýdlant v Čechách	13
546622	Frýdlant v Čechách předměstí	15
334045	Fulnek	15
540831	Golčův Jeníkov	13
540930	Golčův Jeníkov město	15
338053	Grešlové Mýto	13
334821	Grygov	12
541292	Háj u Duchcova	15
334243	Háj ve Slezsku	13
758656	Hájek	13
546028	Hajniště	15
334920	Halenkov	13
334128	Halenkov zastávka	15
370353	Hamry nad Sázavou	15
769851	Hamry-Hojsova Stráž	13
335422	Hanušovice	13
347724	Hanušovice Holba	15
335828	Hanušovice zastávka	15
549220	Harrachov	15
564468	Hatě	15
334540	Havířov	11
334615	Havířov střed	14
334748	Havířov-Suchá	15
542134	Havlíčkův Brod	12
542035	Havlíčkův Brod-Perknov	15
735357	Havlovice	15
568311	Havranec	15

Číslo dle SR 70	Název	Kategorie
365957	Havříce	15
735951	Hazlov	13
548321	Hejnice	15
558437	Herálec	13
747527	Herbertov	15
535609	Heroltice	15
731224	Heřmaň	15
734020	Heřmaň obec	15
552166	Heřmaničky	14
341743	Heřmánky	15
746453	Heřmanova Huť	15
557132	Heřmanův Městec	13
334946	Hladké Životice	14
348144	Hladké Životice místní nádraží	15
759159	Hlavno	14
561613	Hledsebe	15
335950	Hlinsko pod Hostýnem	15
548537	Hlinsko v Čechách	13
548834	Hlinsko-Kouty	15
540245	Hlízov	15
335927	Hlubočky	13
336123	Hlubočky zastávka	15
336024	Hlubočky-Mariánské Údolí	13
733022	Hluboká nad Vltavou	13
734822	Hluboká nad Vltavou-Zámostí	13
741520	Hluboká u Borovan	15
534040	Hluboký Důl	15

Číslo dle SR 70	Název	Kategorie
335042	Hlučín	15
331025	Hlušovice	15
533703	Hnátnice	15
556407	Hněvčeves	12
542878	Hněvice	12
335141	Hnojník	13
749606	Hodice	15
562868	Hodkov	15
562264	Hodkov zastávka	15
542720	Hodkovice nad Mohelkou	13
573600	Hodkovice u Trutnova	15
759423	Hodňov	15
338251	Hodonice	13
338459	Hodonín	12
371955	Hodonín zastávka	15
769950	Hojsova Stráž-Brčálník	15
346742	Holasovice	15
740928	Holečkov	15
533273	Holedeček	15
338558	Holešov	13
537399	Holetice	15
548735	Holetín	15
555136	Holice	15
555235	Holice zastávka	15
753129	Holkov	13
765552	Holostřevy	15
731851	Holoubkov	11

Číslo dle SR 70	Název	Kategorie
760520	Holubov	15
747352	Holýšov	13
736058	Horažďovice	13
738658	Horažďovice předměstí	11
336420	Horka nad Moravou	15
561563	Horka nad Sázavou	15
547133	Horka u Chrudimi	15
566901	Horka u Staré Paky	13
540542	Horky u Čáslavi	15
753723	Horky u Tábora	15
573709	Horní Adršpach	15
542274	Horní Beřkovice	15
742858	Horní Blatná	15
569509	Horní Branná	15
750851	Horní Bříza	13
750752	Horní Bříza zastávka	15
758029	Horní Cerekev	13
752220	Horní Dvořiště	13
541797	Horní Háj	15
338822	Horní Heřmanice	15
751255	Horní Hradiště	15
563098	Horní Kamenice	15
562256	Horní Leděč	15
336529	Horní Lideč	13
337022	Horní Lipová	13
346726	Horní Moštěnice	14
731026	Horní Nerestce	15

Číslo dle SR 70	Název	Kategorie
565002	Horní Nová Ves	15
759126	Horní Planá	13
758623	Horní Planá zastávka	15
543165	Horní Počaply	15
567297	Horní Podluží	15
562496	Horní Police	13
565390	Horní Poustevna	15
343244	Horní Povelice	15
545822	Horní Řasnice	15
570499	Horní Řepčice	15
743351	Horní Slavkov	10
743252	Horní Slavkov - Kounice	15
743450	Horní Slavkov zastávka	10
334847	Horní Suchá	15
571703	Horní Sytová	15
335349	Horní Tošanovice	15
757922	Horní Ves	15
757724	Horní Vilímeč	15
751727	Horní Vltavice	15
766253	Horšovský Týn	13
735324	Horusice	15
545640	Hořátev	15
550582	Hořesedly	15
537498	Hořetice	13
759720	Hořice na Šumavě	13
555805	Hořice v Podkrkonoší	13
568501	Hoříněves	15

Číslo dle SR 70	Název	Kategorie
731349	Hořovice	11
734723	Hosín	15
336222	Hostašovice	13
345553	Hostěrádky-Rešov	15
360859	Hostětín	15
569707	Hostinné	13
569715	Hostinné město	15
536565	Hostivice	13
536664	Hostivice-Litovice	15
536763	Hostivice-Sadová	15
536862	Hostivice-U hřbitova	15
548099	Hostomice nad Bílinou	15
768242	Hostomice pod Brdy	15
755454	Hostouň	15
540765	Hostouň u Prahy	15
744755	Hoštěc	15
539833	Hoštejn	15
750422	Hoštice u Volyně	15
341552	Hoštice-Heroltice	15
530790	Hoštka	13
354522	Hovězí	15
547364	Hovorčovice	15
571901	Hrabačov	15
339929	Hrabišín	15
760736	Hradce	15
364356	Hradčany	15
338954	Hradčovice	13

Číslo dle SR 70	Název	Kategorie
531202	Hradec Králové hlavní nádraží	11
531509	Hradec Králové zastávka	15
531301	Hradec Králové-Kukleny	15
531400	Hradec Králové-Slezské Předměstí	13
335745	Hradec nad Moravicí	15
334573	Hradec nad Svitavou	14
535591	Hradec u Kadaně	15
747253	Hradec u Stoda	15
345827	Hradec-Nová Ves	15
331140	Hrádek (Gródek)	14
575225	Hrádek nad Nisou	11
763052	Hrádek u Rokycan	15
736454	Hrádek u Sušice	13
746925	Hradiště u Blatné	15
551697	Hradiště v Čechách	15
351825	Hrachovec	15
337220	Hranice na Moravě	11
337329	Hranice na Moravě město	13
730655	Hranice v Čechách	15
734624	Hrdějovice	15
736629	Hrdlořezy	15
559195	Hrdly	15
558700	Hrdoňovice	15
541896	Hrob	15
559492	Hrobce	12
556134	Hrochův Týnec	15
538207	Hronov	13

Číslo dle SR 70	Název	Kategorie
538306	Hronov zastávka	15
734855	Hroznětín	15
734954	Hroznětín zastávka	15
553404	Hrubá Skála	13
337527	Hrubá Voda	13
337626	Hrubá Voda zastávka	15
334326	Hrubá Voda-Smilov	15
339051	Hrušky	10
339150	Hrušky zastávka	15
552737	Hrušová	15
339259	Hrušovany nad Jevišovkou-Šanov	13
339556	Hrušovany u Brna	11
764951	Hřebený	PDV
742023	Hřibčcí	15
549691	Hřivice	13
731414	Hudčice	15
339853	Hulín	12
558130	Humpolec	13
738229	Husinec	15
335026	Huslenky	15
335125	Huslenky zastávka	15
338129	Hustopeče nad Bečvou	13
340158	Hustopeče u Brna	13
340257	Huštěnovice	12
559260	Hvězdonice	13
354555	Hvězdoňovice	15
537308	Hynčice	15

Číslo dle SR 70	Název	Kategorie
760744	Hýskov	13
561266	Chabeřice	15
541672	Charvatce	15
356956	Charvátská Nová Ves	15
750356	Cheb	11
750364	Cheb-Skalka	15
750257	Cheb-Všeboř	15
759647	Chlum u Rakovníka	15
753350	Chlumčany u Dobřan	13
536771	Chlumčany u Loun	13
530501	Chlumeck nad Cidlinou	13
753228	Chlumeck u Českých Budějovic	15
543991	Chlumeck u Chabařovic	15
545962	Chlumín	15
564369	Chmeliště	15
538132	Choceň	11
559369	Chocerady	15
740555	Chodov	11
749556	Chodová Planá	11
738252	Chodská Lhota	15
341024	Cholina	15
557439	Choltice	13
534891	Chomutov	13
582197	Chomutov město	14
557496	Choratice	15
340372	Chornice	13
549238	Chotěboř	13

Číslo dle SR 70	Název	Kategorie
536094	Chotěbudice	15
332445	Chotěbuz (Kocobědz)	14
533596	Chotějovice	15
554691	Chotěšov pod Hazmburkem	13
747055	Chotěšov u Stoda	15
544817	Chotětov	13
569905	Chotěvice	15
552190	Chotiměř	15
564963	Chotouchov	15
530402	Choťovice	13
552760	Chotoviny	11
531467	Chotutice	15
734921	Chotýčany	13
575423	Chotyně	15
557967	Chrást nad Sázavou	15
546937	Chrast u Chrudimi	13
732453	Chrást u Plzně	15
732552	Chrást u Plzně obec	15
741058	Chrást u Plzně zastávka	15
575522	Chrastava	11
575720	Chrastava-Andělská Hora	15
335521	Chrastice	15
550681	Chrástky	13
534263	Chrástky zastávka	15
738625	Chroboly	15
341057	Chropyně	13
566265	Chroustov	15

Číslo dle SR 70	Název	Kategorie
546531	Chrudim	13
555532	Chrudim město	15
546739	Chrudim zastávka	15
562058	Chřenovice	15
562157	Chřenovice-Podhradí	15
567495	Chřibská	13
341123	Chudobín	15
335943	Chuchelná	15
573303	Chvaleč	15
740126	Chvalešovice	15
535039	Chvaletice	14
352955	Chvalkovice na Hané	15
544064	Chvatěruby	13
548768	Chýně	15
548867	Chýně jih	15
743229	Chýnov	13
733352	Chyšce	15
341255	Ivančice	13
349951	Ivančice letovisko	15
341354	Ivančice město	15
341453	Ivanovice na Hané	13
571208	Jablonec nad Jizerou	15
571307	Jablonec nad Jizerou-Hradsko	15
550921	Jablonec nad Nisou	13
550020	Jablonec nad Nisou centrum	15
551127	Jablonec nad Nisou dolní nádraží	15
551028	Jablonec nad Nisou zastávka	15

Číslo dle SR 70	Název	Kategorie
550822	Jablonecké Paseky	15
534008	Jablonné nad Orlicí	13
572099	Jablonné v Podještědí	13
338426	Jablůnka	13
350553	Jackov	15
335547	Jakartovice	15
341842	Jakubčovice nad Odrou	15
348425	Jamartice	15
534107	Jamně nad Orlicí	15
334656	Jankovice	15
354621	Janová	15
737650	Janovice nad Úhlavou	13
573402	Janovice u Trutnova	15
344952	Jarohněvice	15
567701	Jaroměř	11
567800	Jaroměř zastávka	15
341651	Jaroměřice nad Rokytnou	13
757229	Jarošov nad Nežárkou	13
371757	Javorník nad Veličkou zastávka	15
338624	Javorník ve Slezsku	15
567594	Jedlová	13
341859	Jemnice	15
536367	Jeneč	13
540666	Jeneč zastávka	15
557033	Jeníkovice	15
543181	Jeníkov-Oldřichov	11
556100	Jeřice	15

Číslo dle SR 70	Název	Kategorie
542522	Jeřmanice	13
337253	Jesenec	15
761643	Jesenice	13
338921	Jeseník	13
348243	Jeseník nad Odrou	14
552802	Jesenný	15
352559	Jestřabice	15
568394	Jestřebí	13
552364	Ješetice	14
738856	Jetenovice	15
755926	Jetětice	15
341974	Jevíčko	15
354258	Jevišovka	15
749903	Jezdovice	15
554204	Jičín	13
554303	Jičín zastávka	15
563304	Jičíněves	15
342154	Jihlava	13
342253	Jihlava město	13
341958	Jihlava-Bosch Diesel	15
342055	Jihlava-Staré Hory	15
757807	Jihlávka	13
562918	Jíkev	15
571604	Jilemnice	13
334342	Jilešovice	15
543090	Jílové u Děčína	15
557363	Jílové u Prahy	13

Číslo dle SR 70	Název	Kategorie
741421	Jílovce	13
549790	Jimlín	15
768846	Jince	13
339028	Jindřichov na Moravě	13
336446	Jindřichov ve Slezsku	13
545723	Jindřichovice pod Smrkem	15
545921	Jindřichovice pod Smrkem-Skanzen	15
743625	Jindřichův Hradec	13
549063	Jinočany	15
554006	Jinolice	15
540096	Jirkov	15
540195	Jirkov zastávka	14
550525	Jiřetín pod Bukovou	15
567396	Jiřetín pod Jedlovou	15
546267	Jiřice	15
564492	Jiříkov-Filipov	15
336545	Jistebník	12
553800	Jivany	15
334425	Jívová	15
550327	Josefův Důl	13
560664	Kácov	13
560961	Kácov zastávka	15
535369	Kačice	15
537993	Kadaň	13
535690	Kadaň předměstí	13
545616	Kadaň-Bystřice	15
535492	Kadaň-Prunéřov	11

Číslo dle SR 70	Název	Kategorie
536797	Kadaňský Rohozec	15
759928	Kájov	13
572404	Kalná Voda	PDV
543595	Kamenec	15
558338	Kamenice u Humpolce	15
336859	Kamenná	15
532242	Kamenné Zboží	15
535260	Kamenné Žehrovice	13
538561	Kamenný Most u Kralup nad Vltavou	15
557561	Kamenný Přívoz	15
753327	Kamenný Újezd u Českých Budějovic	13
753426	Kamenný Újezd u Českých Budějovic zastávka	15
746057	Kamenný Újezd u Nýřan	15
762856	Kamenný Újezd u Rokycan	15
561118	Kanina	15
333021	Kaple	15
752725	Kaplice	13
530709	Káranice	13
756825	Kardašova Řečice	13
551721	Karlov pod Ještědem	13
353722	Karlovice	PKP CI
354225	Karlovice zastávka	PKP CI
553305	Karlovice-Sedmihorky	15
758755	Karlovy Vary	11
745851	Karlovy Vary dolní nádraží	13
745711	Karlovy Vary-Aréna	15
745653	Karlovy Vary-Březová	15

Číslo dle SR 70	Název	Kategorie
758854	Karlovy Vary-Dvory	15
531863	Karlštejn	12
353227	Karolinka	15
352724	Karolinka zastávka	15
336743	Karviná hlavní nádraží	11
336842	Karviná-Darkov	15
731604	Kařez	14
731653	Kařízek	11
746834	Kasejovice	13
746339	Kasejovice zastávka	15
752469	Kaštice	13
761320	Katovice	13
560516	Katusice	15
751057	Kaznějov	13
738351	Kdyně	13
745455	Kfely	15
732156	Klabava	14
535161	Kladno	13
535567	Kladno město	15
535666	Kladno-Dubí	13
536169	Kladno-Ostrovec	13
535468	Kladno-Rozdělov	15
536060	Kladno-Švermov	15
535765	Kladno-Vrapice	15
535195	Kláštepec nad Ohří	13
569608	Klásterská Lhota	15
737452	Klatovy	11

Číslo dle SR 70	Název	Kategorie
737353	Klatovy město	15
735654	Klenčí pod Čerchovem	15
541474	Kleneč	15
557637	Klešice	15
555862	Klínec	15
537266	Klobuky v Čechách	13
350249	Klokočov	15
531061	Klučov	15
537860	Kmetiněves	15
534164	Kněževes	15
752568	Kněžice	15
544213	Kněžmost	15
558502	Kněžnice	15
363051	Knínice u Boskovic	15
343343	Koberno	15
337824	Kobylá nad Vidnavkou	15
342758	Kobylí na Moravě	13
363358	Kojatín	15
342956	Kojetice na Moravě	13
547166	Kojetice u Prahy	15
343061	Kojetín	13
534933	Kojice	15
545111	Kojovice	15
754952	Kokašice	15
539767	Koleč	15
533968	Kolešovice	15
534149	Kolín	11

Číslo dle SR 70	Název	Kategorie
534842	Kolín dílny	15
534446	Kolín místní nádraží	15
534248	Kolín zastávka	14
736652	Kolinec	13
534347	Kolín-Zálabí	14
559716	Kolomuty	15
330829	Komňátka	15
550095	Konětopy	15
337352	Konice	15
755058	Konstantinovy Lázně	15
563007	Kopidlno	13
337048	Kopřivnice	11
337147	Kopřivnice zastávka	15
763755	Kornatice	15
763854	Kornatice rybník	15
565069	Kořenice	15
549121	Kořenov	15
549428	Kořenov zastávka	15
761544	Kosobody	15
551960	Kosova Hora	15
361550	Kostelany nad Moravou	15
343855	Kostelec na Hané	13
546366	Kostelec nad Labem	15
532408	Kostelec nad Orlicí	13
532507	Kostelec nad Orlicí město	15
557835	Kostelec u Heřmanova Městce	13
557934	Kostelec u Heřmanova Městce-Písník	15

Číslo dle SR 70	Název	Kategorie
758409	Kostelec u Jihlavy	12
758417	Kostelec u Jihlavy masna	15
536532	Kostěnice	12
531343	Kostomlaty nad Labem	13
542472	Kostomlaty pod Řípem	15
545418	Košátky	15
566109	Košťálov	13
554790	Koštice nad Ohří	15
532499	Koštov	15
345058	Kotojedy	15
746636	Kotouň	15
758060	Kotvina	15
550384	Kounov	15
565366	Kouřim	15
738450	Kout na Šumavě	15
555300	Kovač	15
540161	Kováry	15
538991	Kovářská	15
539197	Kovářská městys	15
738963	Kovčín	15
333146	Kozmice	15
748350	Kozolupy	11
762450	Kožlany	15
331827	Kožušany	15
344556	Krahulov	13
344655	Kralice nad Oslavou	13
353524	Kraličky	15

Číslo dle SR 70	Název	Kategorie
535005	Králíky	15
534909	Králíky zastávka	15
572800	Královec	15
762559	Kralovice u Rakovníka	15
538165	Kralovice u Zlonic	15
758953	Královské Poříčí	15
543967	Kralupy nad Vltavou	11
539460	Kralupy nad Vltavou předměstí	13
545269	Kralupy nad Vltavou-Minice	15
730846	Králův Dvůr	15
730945	Králův Dvůr-Popovice	15
539635	Krasíkov	14
765354	Kraslice	PDV
765255	Kraslice předměstí	PDV
765347	Kraslice-Pod vlekem	PDV
566596	Krásná Lípa	13
566695	Krásná Lípa město	15
548826	Krásná Studánka	15
340448	Krásné Loučky	15
536193	Krásný Dvůr	15
743153	Krásný Jez	15
743161	Krásný Jez zastávka	15
546325	Krásný Les	15
546424	Krásný Les bažantnice	15
562561	Krasoňovice	15
530907	Kratonohy	15
570994	Kravaře v Čechách	15

Číslo dle SR 70	Název	Kategorie
337543	Kravaře ve Slezsku	13
337642	Kravaře-Kouty	15
557660	Krhanice	15
351924	Krhová	15
339044	Krnov	13
339143	Krnov-Cvilín	15
544718	Krnsko	15
344754	Kroměříž	13
339440	Kroměříž-Oskol	15
545319	Kropáčova Vrutice	13
550434	Krouna	15
551739	Krouna zastávka	15
761742	Krty	15
533760	Krupá	13
544197	Krupka	15
544395	Krupka město	15
532796	Krupka-Bohosudov	13
752162	Kryry	13
552026	Kryštofovo Údolí	15
357657	Křemeneč	15
760629	Křemže	13
573105	Křenov	15
331355	Křenovice dolní nádraží	15
345454	Křenovice horní nádraží	13
765958	Křenovy	15
554899	Křesín	15
560391	Křešice u Děčína	15

Číslo dle SR 70	Název	Kategorie
531095	Křešice u Litoměřic	15
538199	Křimov	15
538595	Křimov zastávka	15
538496	Křimov-Suchdol	15
562611	Křinec	13
760041	Křivoklát	15
345751	Křižanov	11
361154	Křižanovice	15
551820	Křižany	13
553602	Ktová	15
751628	Kubova Huť	15
567602	Kuks	15
569400	Kunčice nad Labem	13
339341	Kunčice pod Ondřejníkem	11
349274	Kunčina	15
345959	Kunovice	13
346056	Kunovice zastávka	15
346361	Kunovice-Loučka	13
346551	Kuřim	11
540146	Kutná Hora hlavní nádraží	12
563460	Kutná Hora město	13
563668	Kutná Hora předměstí	15
563767	Kutná Hora-Sedlec	15
551234	Květná	13
551630	Květná zastávka	15
558304	Kyje u Jičína	15
534594	Kyjice	11

Číslo dle SR 70	Název	Kategorie
346759	Kyjov	13
346858	Kyjov zastávka	15
342147	Kylešovice	15
759357	Kynšperk nad Ohří	13
564294	Kytlice	15
356154	Ladná	15
553537	Lanškroun	15
533802	Lanšperk	13
346957	Lanžhot	11
759746	Lašovice	13
360651	Laštovičky	15
561662	Laziště	15
564807	Lázně Bělohrad	13
749754	Lázně Kynžvart	11
547869	Lázně Toušeň	15
551499	Lbín	15
750828	Lčovice	15
561951	Ledeč nad Sázavou	13
560060	Ledečko	13
562819	Ledečky	15
347054	Lednice	15
347153	Lednice rybníky	15
545798	Lenešice	13
752022	Lenora	15
751529	Lenora zastávka	15
354720	Leskovec	15
742825	Leskovice	15

Číslo dle SR 70	Název	Kategorie
541136	Leština u Světlé	13
533307	Letohrad	11
347252	Letovice	13
347351	Letovice zastávka	15
566505	Levínská Olešnice	15
732966	Ležky	15
740225	Lhota pod Horami	15
531004	Lhota pod Libčany	15
535237	Lhota pod Přeloučí	15
334441	Lhota u Opavy	15
570606	Lhota u Trutnova	15
553362	Lhota Veselka	15
350652	Lhotice u Jemnice	15
352021	Lhotka nad Bečvou	11
561415	Lhotka u Mělníka	15
561514	Lhotka u Mělníka zastávka	15
544361	Libčice nad Vltavou	12
544569	Libčice nad Vltavou-Letky	15
570903	Libeč	15
530584	Liběchov	13
753921	Libějvice	15
740720	Libějovice	15
542126	Liberec	11
551523	Liberec-Horní Růžodol	13
542225	Liberec-Rochlice	15
570390	Liběšice	13
532549	Libice nad Cidlinou	13

Číslo dle SR 70	Název	Kategorie
339820	Libina	13
733261	Libkovice	15
537290	Libočany	15
531392	Libochovany	15
554493	Libochovice	13
554998	Libochovice město	15
768648	Libomyšl	15
559005	Libošovice	15
543496	Libouchec	15
566208	Libštát	15
553909	Libuň	13
553917	Libuň zastávka	15
336727	Lidečko	14
336826	Lidečko ves	14
534305	Lichkov	13
349779	Linhartice	15
340547	Linhartovy	15
560417	Líny	15
542332	Lípa	13
370551	Lípa nad Dřevnicí	13
530204	Lípa nad Orlicí	15
751420	Lipka	15
763656	Lipnice	15
340422	Lipník nad Bečvou	12
748129	Lipno nad Vltavou	15
371351	Lipov	15
340521	Lipová Lázně	13

Číslo dle SR 70	Název	Kategorie
340620	Lipová Lázně jeskyně	15
340729	Lipová Lázně zastávka	15
750059	Lipová u Chebu	11
565994	Lipová u Šluknova	15
349142	Liptaň	15
339747	Lískovec u Frýdku	13
549196	Lišany u Žatce	13
755629	Líšnice	15
565721	Líšný	15
767640	Liteň	13
533000	Litice nad Orlicí	13
544312	Litkovice	15
558395	Litochovice nad Labem	15
573196	Litoměřice Cihelna	15
570192	Litoměřice horní nádraží	13
531194	Litoměřice město	14
552133	Litomyšl	15
552034	Litomyšl zastávka	15
552232	Litomyšl-Nedošín	15
340828	Litovel	15
341222	Litovel město	15
340927	Litovel předměstí	13
340844	Litultovice	15
540898	Litvínov	13
537092	Litvínov město	15
747022	Lnáře	15
546960	Lobkovice	15

Číslo dle SR 70	Název	Kategorie
343160	Lobodice	15
548461	Loděnice	13
568709	Lochenice	15
768549	Lochovice	13
745257	Loket	15
743658	Loket předměstí	15
541094	Lom u Mostu	15
541599	Lom u Mostu zastávka	15
765453	Lom u Stříbra	15
757054	Lom u Tachova	15
737320	Lomnice nad Lužnicí	13
557801	Lomnice nad Popelkou	13
333328	Lomnice u Rýmařova	15
754556	Lomnička	15
540674	Loucká	15
738054	Loučím	15
743757	Loučky	15
747923	Loučovice	15
748020	Loučovice zastávka	15
541490	Louka u Litvínova	13
744953	Louka u Mariánských Lázní	15
371559	Louka u Ostrohu	15
336057	Loukov	15
543215	Loukov u Mnichova Hradiště	13
339846	Louky nad Olší	11
545996	Louny	13
546093	Louny město	15

Číslo dle SR 70	Název	Kategorie
546192	Louny předměstí	13
546390	Louny střed	15
564203	Lovčice obec	15
558593	Lovosice	11
558791	Lovosice město	15
558890	Lovosice zastávka	15
569996	Lovosice závod	15
550764	Lštění	15
733063	Lubeneč	15
733162	Lubeneč zastávka	15
761841	Lubná	15
767459	Luby u Chebu	15
737254	Luby u Klatov	15
550723	Lučany nad Nisou	15
764852	Luh nad Svatavou	PDV
548222	Luh pod Smrkem	15
347559	Luhačovice	13
734053	Luhov	15
347856	Luka nad Jihlavou	13
557462	Luka pod Medníkem	15
559294	Lukavec	15
341628	Lukavice na Moravě	12
533406	Lukavice v Čechách	15
564401	Luková	15
540039	Luková u Rudoltic v Čechách	15
348151	Luleč	13
539932	Lupěné	15

Číslo dle SR 70	Název	Kategorie
542258	Luštěnice	15
343954	Lutotín	15
753657	Lužany	15
543462	Lužec nad Vltavou	13
548420	Lužec pod Smrkem	15
348250	Lužice	12
534560	Lužná u Rakovníka	13
351528	Lužná u Vsetína	15
737221	Lužnice	15
552323	Lvová	15
531145	Lysá nad Labem	12
531244	Lysá nad Labem-Dvorce	15
731927	Mačkov	15
575928	Machnín	15
575829	Machnín hrad	15
736926	Majdalena	13
739623	Majdalena zastávka	15
569285	Malá Bělá	15
556662	Malá Hraštice	13
331728	Malá Morávka	15
565523	Malá Skála	13
562298	Malá Veleň	15
561191	Malé Březno nad Labem	15
337741	Malé Hoštice	15
543793	Malé Chvojno	15
574103	Malé Svatoňovice	13
558999	Malé Žernoseky	15

Číslo dle SR 70	Název	Kategorie
558908	Malechovice	15
750729	Malenice nad Volyňkou	15
563064	Malešov	13
535294	Málkov	15
732867	Malměřice	15
736751	Malonice	15
740829	Malovice u Netolic	15
560367	Malovidy	15
754028	Malšice	15
347955	Malý Beranov	15
748921	Malý Pěčín	15
756650	Malý Rapotín	15
530287	Malý Újezd	15
348441	Mankovice	15
335158	Marefy	15
744052	Mariánské Lázně	11
744151	Mariánské Lázně město	15
562793	Markvartice	13
543397	Martiněves u Děčína	15
541771	Martiněves u Libochovic	15
366955	Martinice u Velkého Meziříčí	15
569301	Martinice v Krkonoších	13
766352	Mašovice	15
766451	Meclov	15
539296	Měděnec	15
539395	Měděnec zastávka	15
546630	Medlešice	13

Číslo dle SR 70	Název	Kategorie
555763	Měchenice	13
533372	Měcholupy	13
561712	Mělnická Vrutice	15
530188	Mělník	13
530485	Mělník-Mlazice	15
735050	Merklín	15
343269	Měrovice nad Hanou	15
563619	Městec Králové	13
348375	Městečko Trnávka	15
553263	Městečko u Benešova	15
759944	Městečko u Křivoklátu	15
340349	Město Albrechtice	13
547265	Měšice u Prahy	13
763557	Mešno	15
340471	Mezihoří	15
537100	Meziměstí	13
759829	Mezipotočí	15
755124	Meziříčí	15
552562	Mezno	14
565499	Mikulášovice dolní nádraží	13
565598	Mikulášovice horní nádraží	15
565697	Mikulášovice střed	15
348557	Mikulov na Moravě	13
542191	Mikulov v Krušných horách	15
342329	Mikulovice	13
542399	Mikulov-Nové Město	15
747758	Milavče	15

Číslo dle SR 70	Název	Kategorie
739151	Mileč	15
733626	Milenovice	15
755520	Milevsko	13
744359	Milhostov u Mariánských Lázní	15
748954	Milíkov	11
769141	Milín	13
533562	Milostín	15
338228	Milotice nad Bečvou	15
342527	Milotice nad Opavou	13
544148	Milovice	13
571695	Mimoň	13
551663	Minartice	15
547729	Minkovice	15
348755	Miroslav	13
763151	Mirošov	13
763250	Mirošov město	15
550368	Mirošovice u Prahy	14
564161	Mirošovice u Rataj nad Sázavou	15
740654	Mírová	15
730226	Mirovice	13
542639	Mírovka	15
564260	Mitrov	15
544510	Mladá Boleslav hlavní nádraží	13
559914	Mladá Boleslav město	11
544411	Mladá Boleslav-Debrž	13
572305	Mladé Buky	PDV
340646	Mladecko	15

Číslo dle SR 70	Název	Kategorie
341321	Mladeč	15
341420	Mladeč jeskyně	15
349076	Mladějov na Moravě	15
558601	Mladějov v Čechách	15
349522	Mladějovice	15
534503	Mladkov	15
751453	Mladotice	13
751354	Mladotice zastávka	15
543561	Mlčechvosty	15
562900	Mlýnec	15
535500	Mlýnický Dvůr	15
564195	Mlýny	13
541078	Mnetěš	15
756924	Mnich	15
550160	Mnichovice	15
543512	Mnichovo Hradiště	13
556365	Mníšek pod Brdy	13
548628	Mníšek u Liberce	13
734426	Modlešovice	15
543694	Modrá u Děčína	15
349456	Modřice	12
342824	Mohelnice	12
547968	Mochov	15
547463	Mochov zastávka	15
558098	Mojžíř	15
348649	Mokré Lazce	15
736553	Mokrosuky	15

Číslo dle SR 70	Název	Kategorie
556761	Mokrovraty	15
542290	Moldava v Krušných horách	15
536730	Moravany	12
342923	Moravičany	11
334672	Moravská Chrastová	15
349555	Moravská Nová Ves	12
349670	Moravská Třebová	15
349852	Moravské Bránice	13
350058	Moravské Budějovice	13
343020	Moravský Beroun	13
535302	Moravský Karlov	15
351056	Moravský Krumlov	13
351254	Moravský Písek	12
351353	Moravský Písek zastávka	15
336628	Mořkov hlavní trať	15
533992	Most	11
567107	Mostek	13
536995	Most-Kopisty	15
540997	Most-Minerva	15
341040	Mosty u Jablunkova (Mosty koło Jabłonkowa)	11
341149	Mosty u Jablunkova zastávka (Mosty koło Jabłonkowa przystanek)	15
346031	Mošnov, Ostrava Airport	13
550665	Mrač	15
744557	Mrázov	15
541631	Mrzkovice	15
548065	Mstětice	13

Číslo dle SR 70	Název	Kategorie
541573	Mšené Lázně	15
560912	Mšeno	15
550285	Mutějovice	13
533869	Mutějovice zastávka	15
351452	Mutěnice	13
351551	Mutěnice zastávka	15
755355	Mutěnin	15
748327	Mutišov	15
341529	Myslechovice	15
749408	Myslboř	15
552968	Myslíč	15
730325	Myslín	15
736769	Myslkovice	15
731752	Mýto	14
538405	Náchod	13
538702	Náchod zastávka	15
538603	Náchod-Běloves	15
538504	Náchod-Malé Poříčí	15
343129	Náměšť na Hané	15
351759	Náměšť nad Oslavou	13
351858	Napajedla	12
754929	Nasavrky	15
348953	Našiměřice	15
552729	Návarov	15
334151	Návojná	15
336248	Návší (Nawsie)	11
759456	Nebanice	14

Číslo dle SR 70	Název	Kategorie
561316	Nebužely	15
340570	Nectava	15
352054	Nedakonice	12
352153	Nedvědice	13
566000	Nedvězí	15
742056	Nejdek	13
742155	Nejdek zastávka	15
742650	Nejdek-Oldřichov	15
742551	Nejdek-Sejfy	15
741959	Nejdek-Suchá	15
742452	Nejdek-Tisová	15
739052	Nekvasovy	15
543660	Nelahozeves	12
543868	Nelahozeves zámek	15
352351	Němčice nad Hanou	13
330225	Nemilany	15
736850	Nemilkov	13
352450	Nemotice	13
563403	Nemyčeves	15
735126	Neplachov	15
739250	Nepomuk	13
562017	Nepřevázka	15
546861	Neratovice	13
546879	Neratovice město	15
546887	Neratovice sídliště	15
352658	Nesovice	13
767848	Nesvačily	15

Číslo dle SR 70	Název	Kategorie
557793	Neštědice	15
557991	Neštěmice	15
741025	Netolice	15
746420	Netolice zastávka	15
546168	Netřeba	15
539361	Neuměřice	15
768440	Neumětely	15
335257	Nevojice	15
352856	Nezamyslice	13
353656	Nezdenice	13
737056	Neznašovy	15
764050	Nezvěstice	13
368555	Níhov	15
750620	Nišovice	15
760645	Nižbor	13
357673	Nížkov	14
540062	Noutonice	13
742122	Nová Buková	15
742726	Nová Cerekev	13
350124	Nová Hradečná	15
762955	Nová Huť	15
567693	Nová Huť v Lužických horách	15
566703	Nová Paka	13
566802	Nová Paka město	15
758920	Nová Pec	13
740852	Nová Role	13
741850	Nová Role zastávka	15

Číslo dle SR 70	Název	Kategorie
736421	Nová Ves nad Lužnicí	13
550624	Nová Ves nad Nisou	15
558106	Nová Ves nad Popelkou	15
556563	Nová Ves pod Pleší	15
741827	Nová Ves u Českých Budějovic	13
531764	Nová Ves u Kolína	15
538694	Nová Ves u Křimova	15
541037	Nová Ves u Leštiny	15
742353	Nové Hamry	15
342725	Nové Heřminovy	PKP CI
741926	Nové Hodějovice	15
741223	Nové Hrady	13
559393	Nové Kopisty	15
339127	Nové Losiny	15
353854	Nové Město na Moravě	13
353953	Nové Město na Moravě zastávka	15
530600	Nové Město nad Cidlinou	13
538900	Nové Město nad Metují	13
545624	Nové Město pod Smrkem	13
543769	Nové Ouholice	14
743955	Nové Sedlo u Lokte	11
534867	Nové Strašecí	13
739524	Nové Údolí	13
551929	Novina	15
544494	Novosedlice	15
354159	Novosedly	13
567891	Nový Bor	13

Číslo dle SR 70	Název	Kategorie
564302	Nový Bydžov	13
766857	Nový Drahov	15
335224	Nový Hrozenkov	15
335323	Nový Hrozenkov zastávka	15
341446	Nový Jičín město	15
767251	Nový Kostel	15
735852	Nový Kramolín	15
343525	Nový Malín	15
548560	Nučice	13
548669	Nučice zastávka	15
532143	Nymburk hlavní nádraží	12
545541	Nymburk město	13
580837	Nymburk předj.n.	13
769554	Nýrsko	13
745950	Nýřany	13
750950	Obora u Kaznějova	15
746321	Obrataň	13
545095	Obrnice	13
559310	Obrubce	15
540401	Očelice	15
348722	Odrlice	15
341644	Odry	15
341701	Odry-Loučky	15
547596	Ohníč	13
564708	Ohnišťany	15
766550	Ohnišťovice	15
568790	Okna	13

Číslo dle SR 70	Název	Kategorie
541938	Okrouhlice	13
354456	Okříšky	13
354654	Olbramkostel	13
551366	Olbramovice	11
548727	Oldřichov v Hájích	15
550830	Oldřiš	15
559591	Oleško	15
354050	Olešná na Moravě	15
534362	Olešná u Rakovníka	15
574707	Olešnice	15
343624	Olomouc hlavní nádraží	11
343723	Olomouc město	15
343822	Olomouc-Hejčín	15
344028	Olomouc-Nová Ulice	13
330324	Olomouc-Nové Sady	15
343921	Olomouc-Řepčín	13
344127	Olomouc-Smetanovy sady	15
765057	Oloví	PDV
539262	Olovnice	13
545764	Olovnice zastávka	15
363853	Omice	15
752626	Omlenice	13
342428	Ondřejovice	15
355321	Ondřejovice zastávka	15
552398	Oparno	15
543132	Opatov	13
543439	Opatovec	15

Číslo dle SR 70	Název	Kategorie
548107	Opatovice nad Labem	15
568808	Opatovice nad Labem-Pohřebačka	13
341941	Opava východ	11
342345	Opava západ	13
340141	Opava zastávka	15
342048	Opava-Komárov	11
365064	Oplocany	15
539304	Opočno pod Orlickými horami	13
549899	Opočno u Loun	15
761445	Oráčov	15
547232	Orel	15
345850	Ořechov	14
541193	Osek	13
541698	Osek město	15
346429	Osek nad Bečvou	15
354753	Osíčko	13
563015	Oskořínek	15
354852	Oslavany	15
367052	Oslavice	15
367151	Oslavička	15
764241	Oslí	15
342949	Osoblaha	15
768143	Osov	15
368654	Osová Bítýška	15
551622	Ostašov	15
349753	Ostopovice	15
531541	Ostrá	15

Číslo dle SR 70	Název	Kategorie
343640	Ostrava hlavní nádraží	11
343947	Ostrava střed	13
344242	Ostrava-Bartovice	11
344143	Ostrava-Kunčice	11
343749	Ostrava-Kunčičky	15
343848	Ostrava-Mariánské Hory	15
343939	Ostrava-Stodolní	14
344341	Ostrava-Svinov	11
344440	Ostrava-Třebovice	12
350447	Ostrava-Vítkovice	11
342733	Ostrava-Zábřeh	15
344648	Ostravice	13
344945	Ostravice zastávka	15
555409	Ostromeř	13
758557	Ostrov nad Ohří	13
355057	Ostrov nad Oslavou	11
769448	Ostrov u Tochovic	15
355552	Ostrožská Nová Ves	13
355651	Ostrožská Nová Ves lázně	15
344721	Ostružná	13
747550	Osvračín	15
749150	Ošelín	13
342246	Otice	15
536409	Otovice	15
536300	Otovice zastávka	15
530543	Otradovice	15
734350	Otročín	15

Číslo dle SR 70	Název	Kategorie
355750	Otrokovice	12
356352	Otrokovice-Trávníky	15
545160	Otvovice	13
530345	Ovčáry	15
758821	Ovesná	15
744458	Ovesné Kladruby	15
738724	Ovesné u Prachatic	15
742924	Pacov	13
738955	Pačejov	11
755223	Padařov	15
537464	Páleček	15
564898	Panský	15
536136	Pardubice hlavní nádraží	11
546333	Pardubice závodíště	15
536631	Pardubice-Černá za Bory	15
536235	Pardubice-Opočíněk	15
536433	Pardubice-Pardubičky	14
546135	Pardubice-Rosice nad Labem	13
576009	Pardubice-Semtín	15
536334	Pardubice-Svítkov	14
345140	Paskov	13
751750	Pastuchovice	15
555094	Pátek	15
536466	Pavlov	15
749259	Pavlovice	13
558064	Peceraď	15
748525	Peč	15

Číslo dle SR 70	Název	Kategorie
541508	Pěčín	15
531160	Pečky	11
541904	Peklo nad Zdobnicí	15
758722	Pěkná	15
742528	Pelhřimov	13
759027	Pernek na Šumavě	15
742759	Pernink	15
756551	Pernolec	15
758169	Perštejn	13
571794	Pertoltice pod Ralskem	15
537076	Peruc	13
536292	Pětipsy	15
542233	Petrkov	15
752063	Petrohrad	13
557264	Petrov u Prahy	15
371054	Petrov u Strážnice	15
557165	Petrov-Chlomek	15
531905	Petrovice nad Orlicí	15
769455	Petrovice nad Úhlavou	15
345249	Petrovice u Karviné	11
741322	Petřín	15
570705	Petřínovice	15
735456	Pila	15
542621	Pilínkov	15
570002	Pilínkov	13
345629	Písečná	13
756528	Písek	13

Číslo dle SR 70	Název	Kategorie
746628	Písek jih	15
756429	Písek město	13
730929	Písek zastávka	15
756536	Písek-Dobešice	15
331959	Pitín zastávka	15
330753	Pivín	13
558239	Plačkov	15
736025	Planá nad Lužnicí	11
749457	Planá u Mariánských Lázní	11
565861	Plaňany	13
566067	Plaňany zastávka	15
751156	Plasy	13
555433	Platěnice	15
552521	Plavy	15
740357	Plesná	15
760355	Plešnice	14
760322	Plešovice	15
540906	Plchůvky	15
570291	Ploskovice	15
556803	Plotiště nad Labem	15
558205	Plouznice	15
559062	Plužiny	15
732750	Plzeň hlavní nádraží	11
752956	Plzeň zastávka	15
750455	Plzeň-Bílá Hora	15
750463	Plzeň-Bolevec	15
732651	Plzeň-Doubravka	14

Číslo dle SR 70	Název	Kategorie
753053	Plzeň-Doudlevice	15
746552	Plzeň-Jižní Předměstí	14
748152	Plzeň-Křimice	11
750554	Plzeň-Orlík	15
746651	Plzeň-Skvrňany	14
739961	Plzeň-Slovany	15
753152	Plzeň-Valcha	13
746560	Plzeň-Zadní Skvrňany	14
754259	Pňovany	11
748558	Pňovany zastávka	15
755256	Poběžovice	13
737957	Pocinovice	13
757625	Počátky-Žirovnice	13
548594	Počeradý	13
752360	Podbořany	13
532341	Poděbrady	12
730457	Podhradí	15
346460	Podhradní Lhota	15
572107	Podhůří	15
356055	Podivín	12
535807	Podlesí	15
538363	Podlešín	13
356378	Pohled	11
541433	Pohled'	15
542530	Pohledští Dvořáci	15
539502	Pohoří	15
353821	Pocheň	PKP CI

Číslo dle SR 70	Název	Kategorie
548438	Pokřikov	15
535799	Poláky	15
344549	Polanka nad Odrou	15
759522	Polečnice	15
530899	Polepy	13
546564	Polerady nad Labem	15
538009	Police nad Metují	13
332460	Police u Valašského Meziříčí	15
563569	Poličany	15
550632	Polička	13
347757	Polichno	15
356758	Polná	15
759621	Polná na Šumavě	13
345447	Polom	12
551135	Pomezí	15
750372	Pomezí nad Ohří	15
551036	Pomezí zastávka	15
363556	Ponětovice	15
571505	Poniklá	15
571406	Poniklá zastávka	15
757526	Popelín	13
362558	Popice	15
331652	Popov	15
358259	Popovice u Rajhradu	15
346155	Popovice u Uherského Hradiště	15
530964	Poříčany	11
550962	Poříčí nad Sázavou	15

Číslo dle SR 70	Název	Kategorie
558163	Poříčí nad Sázavou-Svárov	15
743120	Pořín	15
734251	Poseč	15
549097	Postoloprty	13
345157	Postoupky	15
735753	Postřekov	15
355123	Postřelmov	11
552869	Postupice	13
356857	Požtorná	15
365452	Poteč	15
532804	Potštejn	13
743054	Potůčky	15
742957	Potůčky zastávka	15
335620	Potůčnick	15
751552	Potvorov	15
744854	Poutnov	15
362657	Pouzdrfany	15
557694	Povrly	12
557892	Povrly-Roztoky	15
362350	Pozdátín	15
761221	Pracejovice	15
558197	Prackovice nad Labem	12
570762	Praha hlavní nádraží	11
572362	Praha Masarykovo nádraží	13
530162	Praha-Běchovice	11
530063	Praha-Běchovice střed	15
570168	Praha-Braník	13

Číslo dle SR 70	Název	Kategorie
570366	Praha-Bubny	13
541367	Praha-Bubny Vltavská	15
571166	Praha-Cibulka	15
573360	Praha-Čakovice	13
570663	Praha-Dejvice	13
530360	Praha-Dolní Počernice	14
572610	Praha-Eden	11
570861	Praha-Hlubočepy	15
572560	Praha-Holešovice	11
570465	Praha-Holešovice zastávka	15
549469	Praha-Holyně	15
573469	Praha-Horní Měcholupy	15
548263	Praha-Horní Počernice	12
570960	Praha-Hostivař	11
571075	Praha-Jinonice	15
572875	Praha-Kačerov	15
573568	Praha-Kbely	15
530568	Praha-Klánovice	14
549766	Praha-Kolovraty	15
555268	Praha-Komořany	15
571562	Praha-Krč	13
573667	Praha-Kyje	14
571760	Praha-Libeň	11
573766	Praha-Modřany	10
573865	Praha-Modřany zastávka	11
570275	Praha-Podbaba	14
532564	Praha-Radotín	12

Číslo dle SR 70	Název	Kategorie
573220	Praha-Rajská zahrada	14
572065	Praha-Ruzyně	13
549261	Praha-Řeporyje	13
547661	Praha-Satalice	13
545061	Praha-Sedlec	15
572263	Praha-Smíchov	11
584862	Praha-Smíchov severní nástupiště	15
571463	Praha-Stodůlky	13
549568	Praha-Uhřetěves	11
572669	Praha-Veleslavín	13
573964	Praha-Velká Chuchle	14
572768	Praha-Vršovice	11
573162	Praha-Vysočany	13
572792	Praha-Zahradní Město	11
555367	Praha-Zbraslav	13
540468	Praha-Zličín	13
530261	Praha-Žvahov	11
738328	Prachatice	13
738427	Prachatice lázně	15
557736	Prachovice	13
531103	Praskačka	13
731240	Praskolesy	14
334953	Pravice	15
737726	Pražák	15
532994	Proboštov	15
551325	Proseč nad Nisou	15
569806	Prosečné	15

Číslo dle SR 70	Název	Kategorie
557769	Prosečnice	15
346528	Prosenice	11
551291	Prosetice	15
548339	Prosetín	15
357053	Prostějov hlavní nádraží	13
357251	Prostějov místní nádraží	13
534701	Prostřední Lipka	15
733451	Protivec	15
733824	Protivín	13
733725	Protivín zastávka	15
364554	Prudká zastávka	15
333948	Pržno	11
562462	Předbořice	15
550236	Předhradí	15
568600	Předměřice nad Labem	13
750224	Přední Zborovice	15
746354	Přehýšov	15
535138	Přelouč	12
346627	Přerov	11
753558	Přeštice	13
753459	Přeštice-Zastávka	15
530303	Převýšov	13
345744	Příbor	13
769042	Příbram	13
749531	Příbram sídliště	15
357376	Příbram	11
357475	Příbram zastávka	15

Číslo dle SR 70	Název	Kategorie
761940	Příčina	15
347021	Příkazy	13
763458	Příkosice	13
763359	Příkosice zastávka	15
534065	Přílepy	15
332650	Přímělkov	15
760124	Přísečná	15
543322	Příšovice	13
752428	Pšenic	15
563106	Pšev	15
761247	Pšovlky	15
357756	Ptení	15
564864	Pučery	15
550533	Pustá Kamenice	15
551531	Pustá Kamenice zastávka	15
759845	Pustověty	15
756627	Putim	13
550566	Pyšely	14
350751	Rákovice	15
760447	Račice nad Beroukou	15
568402	Račice nad Trotinou	15
551895	Radejčín	15
531368	Radim	15
749200	Radkov	15
542423	Rádlo	15
741553	Radnice	15
558536	Radňov	15

Číslo dle SR 70	Název	Kategorie
370452	Radňovice	15
732420	Radomyšl	15
732529	Radomyšl zastávka	15
555193	Radonice nad Ohří	10
536698	Radonice u Kadaně	15
362053	Radostice	15
743526	Radostice u Trocnova	15
750125	Radošovice	15
768341	Radouš	15
573204	Radvanice	15
358051	Rájec-Jestřebí	13
358150	Rajhrad	14
760942	Rakovník	13
762542	Rakovník západ	15
534669	Rakovník zastávka	15
358358	Rakšice	13
356253	Rakvice	15
344820	Ramzová	15
758607	Rantířov	13
358556	Rapotice	13
548123	Raspenava	13
332528	Raškov	15
563965	Rataje nad Sázavou	15
564062	Rataje nad Sázavou předměstí	15
560169	Rataje nad Sázavou zastávka	15
560268	Rataje nad Sázavou-Ivaň	15
564765	Ratboř	13

Číslo dle SR 70	Název	Kategorie
734129	Ražice	13
768747	Rejkovice	15
757120	Rodvínov	15
738526	Rohanov	15
358754	Rohatec	12
358952	Rohatec kolonie	15
358853	Rohatec zastávka	15
560219	Rohatsko	15
746255	Rochlov	15
732222	Rojice	15
732057	Rokycany	11
762757	Rokycany předměstí	15
571109	Rokytnice nad Jizerou	15
331520	Rokytnice u Přerova	15
541409	Rokytnice v Orlických horách	15
554436	Ronov nad Doubravou	15
554337	Ronov nad Doubravou zastávka	15
357574	Ronov nad Sázavou	15
345843	Ropice (Ropica)	15
332544	Ropice zastávka (Ropica przystanek)	14
345942	Ropice-Zálesí (Ropica-Zalesie)	15
369256	Rosice u Brna	15
530865	Rostoklaty	15
765156	Rotava	PDV
735829	Roudná	13
542571	Roudnice nad Labem	12
541375	Roudnice nad Labem město	15

Číslo dle SR 70	Název	Kategorie
542779	Roudnice nad Labem-Bezděkov	15
541276	Roudnice nad Labem-Hracholusky	15
359059	Rousínov	13
555334	Roveň	15
553107	Rovensko pod Troskami	13
335653	Rovné-Divišov	15
557538	Rozhovice	15
347450	Rozhraní	15
549436	Rozsochatec	13
335752	Rozsochy	15
348474	Rozstání	15
569103	Roztoky u Jilemnice	13
569129	Roztoky u Jilemnice zastávka	15
760140	Roztoky u Křivoklátu	13
544668	Roztoky u Prahy	11
544965	Roztoky-Žalov	15
562710	Rožďalovice	13
747428	Rožmberk nad Vltavou	15
764449	Rožmitál pod Třemšínem	15
359257	Rožná	13
347823	Rožnov pod Radhoštěm	13
547398	Rtyně nad Bílinou	15
574400	Rtyně v Podkrkonoší	15
574608	Rtyně v Podkrkonoší zastávka	15
348128	Ruda nad Moravou	13
367359	Rudíkov	15
331926	Rudná pod Pradědem	15

Číslo dle SR 70	Název	Kategorie
332221	Rudná pod Pradědem zastávka	15
549162	Rudná u Prahy	13
548966	Rudná zastávka	15
539437	Rudoltice v Čechách	12
564591	Rumburk	13
565093	Rumburk zastávka	15
537407	Ruprechtice	15
538892	Rusová	15
541805	Rybná nad Zdobnicí	15
752329	Rybník	13
567198	Rybniště	13
541102	Rychnov nad Kněžnou	13
541201	Rychnov nad Kněžnou zastávka	15
542324	Rychnov u Jablonce nad Nisou	13
567909	Rychnovek	15
556266	Rymaně	15
348326	Rýmařov	15
742429	Rynárec	15
535062	Rynholec	15
552224	Rynoltice	13
546226	Řasnice	15
546127	Řasnice zastávka	15
534834	Řečany nad Labem	12
547091	Řehlovice	13
732727	Řepice	15
559815	Řepov	15
574905	Řešetova Lhota	15

Číslo dle SR 70	Název	Kategorie
533091	Řetenice	11
532168	Řevnice	12
534768	Řevničov	13
544767	Řež	14
549865	Říčany	11
552430	Řídký	15
359455	Říkonín	11
359562	Říkovice	12
735639	Řípec	15
735621	Řípec-Dráčov	15
550939	Sádek u Poličky	15
533174	Sádek u Žatce	15
734558	Sadov	15
556308	Sadová	15
734657	Sadov-Podlesí	15
545145	Sadská	13
749952	Salajna	15
750000	Salavice	15
559161	Samechov	13
559864	Samopše	15
530212	Sány	15
559666	Sázava	13
359653	Sázava u Žďáru	11
559765	Sázava zastávka	15
541235	Sázavka	15
531491	Sebuzín	13
551762	Sedlčany	15

Číslo dle SR 70	Název	Kategorie
366658	Sedlec u Mikulova	13
741157	Sedlecko	15
749507	Sedlejev	13
542928	Sedlejšovice	15
732024	Sedlice	15
732123	Sedlice město	15
537035	Sedlíštko	15
346080	Sedlnice	15
346049	Sedlnice předjízdne koleje	13
543231	Semanín	15
565903	Semily	13
553701	Semínova Lhota	15
565804	Semonice	15
766154	Semošice	15
766055	Semošice-Peřina	15
568303	Sendražice	15
348623	Senice na Hané	13
348821	Senice na Hané zastávka	15
550269	Senohraby	11
761049	Senomaty	15
755421	Sepekov	15
736124	Sezimovo Ústí	14
359752	Silůvky	13
359851	Skalice nad Svitavou	12
567990	Skalice u České Lípy	15
767053	Skalná	15
560110	Skalsko	15

Číslo dle SR 70	Název	Kategorie
733923	Skály	15
360552	Sklené nad Oslavou	11
555664	Skochovice	15
346148	Skotnice	15
554840	Skovice	15
561019	Skramouš	15
347120	Skrbeň	15
353920	Skrbovice	PKP CI
346643	Skrochovice	13
738823	Skříněřov	15
564500	Skřivany	15
767749	Skuhrov pod Brdy	15
764340	Skuhrov pod Třemšínem	15
550137	Skuteč	13
765651	Skviřín	15
538066	Slaný	13
538264	Slaný předměstí	15
753822	Slapy	15
541706	Slatina nad Zdobnicí	15
555292	Slatina pod Hazmburkem	15
553131	Slatina u Vysokého Mýta	15
546838	Slatiňany	13
334623	Slatinice	15
555391	Slavětín nad Ohří	15
731513	Slavětín u Březnice	15
749101	Slaviboř	15
360750	Slavičín	13

Číslo dle SR 70	Název	Kategorie
361055	Slavkov u Brna	13
340240	Slavkov u Opavy	15
558635	Slavnič	15
748228	Slavonice	13
541300	Slemeno	15
343541	Slezské Rudoltice	15
564104	Slibovice	15
730523	Smetanova Lhota	15
564609	Smidary	13
733956	Smilov	15
568006	Smiřice	13
568204	Smiřice zastávka	15
562553	Smrčná	15
550228	Smržovka	13
549923	Smržovka dolní nádraží	15
550129	Smržovka střed	15
552927	Smržovka-Luční	15
743427	Smyslov	15
555607	Sobčice	15
735720	Soběslav	11
560763	Soběšín	15
549139	Sobíňov	15
558809	Sobotka	15
361253	Sokolnice-Telnice	13
764555	Sokolov	11
541003	Solnice	13
541052	Solnice zastávka	15

Číslo dle SR 70	Název	Kategorie
549998	Solopysky	15
532903	Sopotnice	15
752121	Soumarský Most	15
739029	Spálenec	15
552901	Spálov	15
738559	Spáňov	15
351957	Spytihněv	15
531962	Srbsko	15
739359	Srby	15
568493	Srní u České Lípy	13
538231	Srubby	15
547299	Stadice	15
334144	Stachovice	15
765859	Staňkov	13
530444	Stará Boleslav	13
556860	Stará Huť	15
566406	Stará Paka	13
741652	Stará Role	13
546432	Staré Jesenčany	15
565192	Staré Křečany	15
349027	Staré Město pod Sněžníkem	15
361451	Staré Město u Uherského Hradiště	12
563502	Staré Místo u Jičína	15
756452	Staré Sedliště	15
568691	Staré Splavy	15
769059	Starec	15
574806	Starkoč	13

Číslo dle SR 70	Název	Kategorie
534644	Starý Kolín	14
739854	Starý Plzenec	13
562595	Starý Šachov	15
361659	Stařeč	13
731141	Stašov	15
568907	Stéblová	13
568931	Stéblová obec	15
750158	Stebnice	15
751966	Stebno	15
755827	Stehlovice	15
747154	Stod	13
534966	Stochov	13
739425	Stožec	15
754754	Strahov	15
762344	Strachovice	15
761023	Strakonice	11
550061	Strančice	11
540575	Straškov	13
531442	Stratov	15
548925	Stráž nad Nisou	15
758359	Stráž nad Ohří	13
756254	Stráž u Tachova	15
357954	Stražisko	15
370957	Strážnice	13
553065	Struhařov	15
738120	Strunkovice nad Blanicí	15
750331	Strunkovice nad Volyňkou obec	15

Číslo dle SR 70	Název	Kategorie
548933	Stružinec	15
562694	Stružnice	13
741751	Střapole	15
540260	Středokluky	13
561068	Střechev nad Sázavou	15
361857	Střelice	11
361865	Střelice dolní	15
336925	Střelná	14
541995	Střelná v Krušných horách	15
761528	Střelské Hoštice	13
349126	Střeň	15
552265	Střeziměř	14
559567	Stříbrná Skalice	15
356477	Stříbrné Hory	15
747857	Stříbro	11
347922	Střítež nad Bečvou	15
335240	Střítež u Českého Těšína	15
336750	Střítež u Jihlavy	15
730556	Studánka	15
362251	Studenec	13
346940	Studénka	11
330548	Studénka město	15
741355	Stupno	15
571190	Stvolínky	15
562454	Stvořidla	15
560615	Sudoměř u Mladé Boleslavi	15
734228	Sudoměř u Písku	15

Číslo dle SR 70	Název	Kategorie
370858	Sudoměřice nad Moravou	13
754523	Sudoměřice u Bechyně	15
552661	Sudoměřice u Tábora	14
736827	Suchdol nad Lužnicí	13
736728	Suchdol nad Lužnicí zastávka	15
348045	Suchdol nad Odrou	12
574202	Suchovršice	15
554394	Sulejovice	15
748657	Sulislav	15
736355	Sušice	13
561498	Svádov	15
764654	Svatava	PDV
764753	Svatava zastávka	PDV
330944	Svatoňovice	15
335455	Svatý Štěpán	15
547893	Světec	13
549964	Svěstice	15
332023	Světlá Hora	15
541334	Světlá nad Sázavou	13
541839	Světlá nad Sázavou město	15
541532	Světlá nad Sázavou-Josefodol	15
563718	Svídnice	15
737825	Svinětice	15
360057	Svitávka	15
543330	Svitavy	12
543538	Svitavy zastávka	15
334771	Svitavy-Lány	15

Číslo dle SR 70	Název	Kategorie
572206	Svoboda nad Úpou	PDV
335646	Svobodné Heřmanice	15
550483	Svojetín	13
731950	Svojkovice	14
749051	Svojšíň	11
567792	Svor	13
755553	Svržno	15
542829	Sychrov	13
532309	Synkov	15
558007	Syřenov	15
362459	Šakvice	11
761148	Šanov	15
564906	Šárovcova Lhota	15
362756	Šatov	13
362855	Šebetov	13
341750	Šebkovice	15
345355	Šelešovice	15
334649	Šenov	15
341545	Šenov u Nového Jičína	15
735027	Ševětín	13
743021	Šimpach	15
354027	Široká Niva	PKP CI
363457	Šlapanice	13
343459	Šlapanice zastávka	14
363275	Šlapanov	13
566190	Šluknov	13
566398	Šluknov zastávka	15

Číslo dle SR 70	Název	Kategorie
770057	Špičák	13
338327	Špičky	15
340943	Štáblovice	15
763953	Štáhlavice	15
739755	Štáhlavy	15
349621	Štarnov	15
733857	Štědrá	15
336149	Štěpánkovice	15
349324	Štěpánov	12
364653	Štěpánovice	15
349423	Šternberk	13
530691	Štětí	13
551861	Štětkovice	15
562363	Štipoklasy	15
730358	Štítary	15
348540	Štítina	13
535708	Štítý	15
348748	Štramberk	13
340679	Šubířov	15
366252	Šumice	15
363655	Šumná	13
349720	Šumperk	13
758102	Švábov	15
761346	Švihov u Jesenice	15
753954	Švihov u Klatov	13
736223	Tábor	11
736132	Tábor-Čáplův Dvůr	15

Číslo dle SR 70	Název	Kategorie
736348	Tábor-Měšice	15
756858	Tachov	13
756759	Tachov zastávka	15
756957	Tachov-Bíletín	15
569202	Tamperle	15
549527	Tanvald	13
549824	Tanvald zastávka	15
549022	Tanvaldský Špičák	15
531269	Tatce	15
539734	Tatenice	14
561597	Těchlovice	15
534206	Těchonín	13
747626	Těchoraz	15
537175	Telce	15
749309	Telč	13
749002	Telč-Staré Město	15
543892	Telnice	15
740324	Temelín	13
744656	Teplá	15
544593	Teplice lesní brána	15
349928	Teplice nad Bečvou	14
537704	Teplice nad Metují	13
573907	Teplice nad Metují město	15
573808	Teplice nad Metují skály	15
532895	Teplice v Čechách	11
551093	Teplice zámecká zahrada	15
745356	Teplička u Karlových Varů	15

Číslo dle SR 70	Název	Kategorie
363754	Tetčice	13
747121	Tchořovice	15
547067	Tišice	15
363952	Tišnov	11
746859	Tlučná	15
364752	Tlumačov	12
537761	Tmář	15
754150	Točnick	15
769240	Tochovice	13
749242	Tochovice zastávka	15
551267	Tomice	15
355826	Tomíkovice	15
549394	Touchovice u Loun	15
565564	Toušice	15
734152	Toužim	15
364968	Tovačov	15
735555	Trhanov	15
553867	Trhový Štěpánov	15
532390	Trmice	11
560714	Trnová	15
532879	Trnovany	15
572198	Trnovany u Litoměřic	15
741728	Trocnov	15
762658	Trojany	15
350025	Troubelice	13
345678	Troubelice střed	15
350223	Troubelice zastávka	15

Číslo dle SR 70	Název	Kategorie
362152	Troubsko	15
349373	Trpík	15
754457	Trpísty	15
759555	Tršnice	13
570200	Trutnov hlavní nádraží	13
570408	Trutnov střed	13
570507	Trutnov zastávka	15
570309	Trutnov-Poříčí	13
572503	Trutnov-Staré město	PDV
571000	Trutnov-Volanov	15
572909	Trutnov-Zelená Louka	PDV
552331	Tržek	15
746438	Třebčice	15
350629	Třebčín	15
531608	Třebechovice pod Orebem	13
754226	Třebelice	15
350850	Třebelovice	15
766758	Třebeň	15
545244	Třebestovice	15
540047	Třebešice	15
340059	Třebětice	13
365551	Třebíč	11
365650	Třebíč-Borovina	15
737122	Třeboň	13
737023	Třeboň lázně	15
556001	Třebovětice	15
539338	Třebovice v Čechách	12

Číslo dle SR 70	Název	Kategorie
534099	Třebošice	11
348946	Třemešná ve Slezsku	13
380064	Třemešná ve Slezsku úzký rozchod	13
755959	Třemešné pod Přimdou	15
750653	Třemošná u Plzně	13
554139	Třemošnice	15
749804	Třešť	13
749705	Třešť město	15
349241	Třinec (Trzyniec)	11
349449	Třinec centrum (Trzyniec Centrum)	15
349340	Třinec-Konská (Trzyniec - KOŇSKA)	14
760421	Třísov	15
540369	Tuchoměřice	15
530766	Tuklaty	14
555839	Tuněchody	15
543009	Turnov	13
553206	Turnov město	15
549493	Tvršice	15
740522	Týn nad Vltavou	13
534743	Týnec nad Labem	14
557868	Týnec nad Sázavou	13
563056	Týniště	15
531806	Týniště nad Orlicí	11
737858	Úborsko	15
743559	Údolí	10
365759	Uherské Hradiště	13
536839	Uhersko	11

Číslo dle SR 70	Název	Kategorie
365858	Uherský Brod	13
354951	Uherský Ostroh	13
563866	Uhlířské Janovice	13
544866	Úholičky	15
555730	Úhřetice	15
343467	Uhřetice obec	15
760249	Újezd nad Zbečnem	15
755652	Újezd Svatého Kříže	15
361352	Újezd u Brna	15
540807	Újezd u Chocně	13
351221	Újezd u Uničova	13
740027	Újezdec u Čičenic	15
366153	Újezdec u Luhačovic	13
544098	Unčín	15
536268	Unhošť	13
351122	Uničov	13
351320	Uničov zastávka	15
555490	Úpohlavy	15
551390	Úpořiny	13
748624	Urbaneč	15
531798	Ústí nad Labem hlavní nádraží	11
531996	Ústí nad Labem sever	11
531590	Ústí nad Labem západ	13
532093	Ústí nad Labem-Střekov	13
538637	Ústí nad Orlicí	11
538736	Ústí nad Orlicí město	14
557900	Ústí u Staré Paky	15

Číslo dle SR 70	Název	Kategorie
354829	Ústí u Vsetína	15
354928	Ústí u Vsetína zastávka	15
570598	Úštěk	13
346841	Úvalno	15
530469	Úvaly	11
546069	Úžice	13
538801	Václavice	13
351429	Valašská Polanka	13
366351	Valašské Klobouky	15
351627	Valašské Meziříčí	11
366450	Valašské Příkazy	15
566497	Valdek	15
352229	Valšov	13
366559	Valtice	13
366757	Valtice město	15
561795	Valtířov	15
749655	Valy u Mariánských Lázní	11
535336	Valy u Přelouče	15
557231	Valy u Přelouče zastávka	15
541607	Vamberk	13
352427	Vápenná	13
566893	Varnsdorf	13
545327	Varnsdorf - pivovar Kocour	15
567099	Varnsdorf staré nádraží	15
342543	Vávrovice	15
753525	Včelná	13
746750	Vejprnice	13

Číslo dle SR 70	Název	Kategorie
539494	Vejprty	15
539593	Vejprty koupaliště	15
539692	Vejprty zastávka	15
555631	Vejvanovice	15
544247	Veleliby	13
752923	Velešín	13
753020	Velešín město	15
533075	Veletice	15
531566	Velim	12
545863	Velká Bučina	15
352823	Velká Bystřice	13
353029	Velká Bystřice zastávka	15
575100	Velká Jesenice	15
337725	Velká Kraš	13
337923	Velká Kraš zastávka	15
371450	Velká nad Veličkou	13
348524	Velká Štáhle	15
732321	Velká Turná	15
330746	Velké Albrechtice	15
560599	Velké Březno	13
552422	Velké Hamry	13
552620	Velké Hamry město	15
337840	Velké Hoštice	15
736157	Velké Hydčice	13
353128	Velké Karlovice	15
353326	Velké Karlovice zastávka	15
366856	Velké Meziříčí	11

Číslo dle SR 70	Název	Kategorie
367458	Velké Meziříčí zastávka	15
367557	Velké Opatovice	13
367656	Velké Pavlovice	13
367854	Velké Pavlovice zastávka	15
538512	Velké Poříčí	15
574301	Velké Svatoňovice	15
532440	Velké Zboží	15
531293	Velké Žernoseky	13
738757	Velký Bor	15
561811	Velký Borek	15
571893	Velký Grunov	15
767152	Velký Luh	15
533141	Velký Osek	13
749028	Velký Pěčín	15
734756	Velký Rybník	15
565895	Velký Šenov	15
566091	Velký Šenov zastávka	15
572297	Velký Valtinov	15
546291	Velče	15
533240	Veltruby	15
545665	Velvary	15
547497	Velvěty	15
551432	Vendolí	15
551333	Vendolí zastávka	15
331249	Vendryně (Wędrynia)	14
533505	Verměřovice	15
535393	Verněřov	15

Číslo dle SR 70	Název	Kategorie
349845	Veřovice	13
350959	Vesce	15
551226	Vesec u Liberce	13
563197	Veselé pod Rabštejnem	15
735522	Veselí nad Lužnicí	11
735423	Veselí nad Lužnicí zastávka	15
367953	Veselí nad Moravou	11
377952	Veselí nad Moravou - Milokošť	15
372052	Veselí nad Moravou-Zarazice	15
557330	Veselí u Přelouče	15
370254	Veselíčko	13
346254	Vésky	15
341156	Věžky	13
359356	Věžná	15
338020	Vidnava	15
571802	Víchová nad Jizerou	15
535997	Vilémov u Kadaně	15
536391	Vilémov u Kadaně město	15
565796	Vilémov u Šluknova	15
562355	Vilémovice	15
557595	Vilsnice	14
751222	Vimperk	13
751321	Vimperk zastávka	15
547422	Višňová	13
548883	Vítanov	15
536490	Vitčice	15
555201	Vitiněves	15

Číslo dle SR 70	Název	Kategorie
350041	Vítkov	15
368050	Vizovice	15
768044	Vižina	15
365353	Vladislav zastávka	15
371856	Vlářský průsmyk	13
742627	Vlásenice	15
535906	Vlaské	15
756122	Vlastec	13
561761	Vlastějovice	13
553560	Vlašim	13
553768	Vlašim zastávka	15
361956	Vlčatín	15
571596	Vlčí Důl-Dobranov	15
570101	Vlčice	15
541045	Vlkaneč	13
735969	Vlkanov	15
368357	Vlkoš	13
737528	Vlkov nad Lužnicí	15
368456	Vlkov u Tišnova	11
559468	Vlkovec	15
744250	Vlkovice	15
371153	Vnorovy	15
562116	Voděřady	15
745158	Vodná	15
737627	Vodňany	15
748251	Vochoz	15
555508	Vojnice	15

Číslo dle SR 70	Název	Kategorie
758458	Vojkovice nad Ohří	13
339655	Vojkovice nad Svratkou	15
740258	Vojtanov	13
730952	Vojtanov obec	15
548636	Vojtěchov	15
739128	Volary	13
548693	Volevčice	14
750521	Volyně	15
766956	Vonšov	15
551564	Voračice	15
552067	Votice	13
760728	Vrábče	15
336255	Vracov	15
357129	Vrahovice	15
543264	Vraňany	12
555466	Vrané nad Vltavou	13
560862	Vranice	15
748756	Vranov u Stříbra	13
368753	Vranovice	12
350348	Vratimov	13
551424	Vratislavice nad Nisou	15
560813	Vrátno	15
548362	Vráž u Berouna	13
730721	Vráž u Písku	13
540971	Vražkov	15
353425	Vrbátky	13
548230	Vrbatův Kostelec	15

Číslo dle SR 70	Název	Kategorie
566166	Vrbčany	15
537365	Vrbičany	15
541870	Vrbka	15
536979	Vrbno nad Lesy	13
353623	Vrbno pod Pradědem	PKP CI
354126	Vrbno pod Pradědem zastávka	PKP CI
756320	Vrcovice	15
540740	Vrdy-Koudelov	15
737155	Vrhavec	15
572008	Vrchlabí	13
551465	Vrchotovy Janovice	15
539007	Vrchoviny	15
752261	Vroutek	13
354423	Vsetín	13
754325	Všechlapy	15
562413	Všejany	15
741256	Všenice	15
532366	Všenory	14
767947	Všeradice	15
556605	Všestary	13
762146	Všesulov	15
530147	Všetaty	13
338756	Všetuly	15
752824	Výheň	15
538793	Výsluní	15
742254	Vysoká Pec	15
552836	Vysoké Mýto	15

Číslo dle SR 70	Název	Kategorie
553032	Vysoké Mýto město	15
358655	Vysoké Popovice	15
536599	Vysoké Třebušice	15
335729	Vysoké Žibřidovice	15
368951	Vyškov na Moravě	13
548792	Vyškov v Čechách	15
741124	Vyšné	15
747725	Vyšší Brod klášter	15
733428	Záblatíčko	15
534545	Záboří nad Labem	12
739920	Záboří u Čičenic	13
355024	Zábřeh na Moravě	11
355420	Zábřeh na Moravě zastávka	15
764142	Zadní Poříčí	15
532069	Zadní Třebaň	12
368159	Zádveřice	15
364851	Záhlinice	15
353755	Záhorovice	15
756221	Záhoří	13
733550	Záhořice	15
571091	Zahrádky u České Lípy	15
566794	Zahrady u Rumburka	15
563908	Zachrašťany	15
369058	Zaječí	12
547034	Zaječice	15
742320	Zajíčkov	15
545368	Zákolany	15

Číslo dle SR 70	Název	Kategorie
539965	Zákolany zastávka	15
571299	Zákupy	13
571398	Zákupy-Božíkov	15
565762	Zalešany	15
542977	Záluží	15
532705	Záměl	15
766659	Zámělič	15
536938	Zámorsk	12
565267	Zásmuky	15
369157	Zastávka u Brna	13
352120	Zašová	15
751826	Zátoň	15
751925	Zátoň-Boubín	15
331322	Zátor	15
345348	Závada	15
762047	Zavidov	15
731729	Závišín	15
554535	Závratec	15
760348	Zbečno	13
360156	Zboněk	15
369454	Zborovice	15
369850	Zborovice zastávka	15
562660	Zbraslavice	13
733220	Zbudov	15
746958	Zbůch	15
549360	Zbuzany	15
345652	Zbýšov	15

Číslo dle SR 70	Název	Kategorie
738922	Zbytiny	15
739656	Zdemyslice	15
545210	Zdětín u Chotětova	15
344051	Zdětín u Prostějova	15
731042	Zdice	11
552125	Zdislava	15
554063	Zdislavice	15
369355	Zdounky	15
769752	Zelená Lhota	13
548164	Zeleneč	15
539569	Zeměchy	15
760223	Zlatá Koruna	13
355222	Zlaté Hory	15
550863	Zlenice	15
337550	Zlín střed	13
355156	Zlín-Dlouhá	15
337659	Zlín-Louky	15
337451	Zlín-Malenovice	13
355859	Zlín-Malenovice zastávka	15
337758	Zlín-Podvesná	15
337857	Zlín-Prštné	15
337956	Zlín-Příluky	15
355255	Zlín-U mlýna	15
733121	Zliv	13
537563	Zlonice	13
537662	Zlonice zastávka	15
544262	Zlonín	15

Číslo dle SR 70	Název	Kategorie
369553	Znojmo	13
348508	Znojmo nemocnice	15
362749	Znojmo-Nový Šaldorf	15
553669	Znosim	15
561365	Zruč nad Sázavou	13
561464	Zruč nad Sázavou zastávka	15
348029	Zubří	15
538462	Zvoleněves	13
339754	Žabčice	14
538090	Žaboklíky	13
565960	Žabonosy	15
542175	Žabovřesky nad Ohří	15
551598	Žalany	15
551796	Žalany zastávka	15
570093	Žalhostice	13
533208	Žamberk	13
563395	Žandov	15
537795	Žatec	13
537894	Žatec západ	13
538108	Žďár nad Metují	15
540609	Žďár nad Orlicí	15
370155	Žďár nad Sázavou	11
548131	Žďárec u Skutče	13
549030	Ždírec nad Doubravou	13
739458	Ždírec u Plzně	13
536896	Ždov	15
533471	Želeč	15

Číslo dle SR 70	Název	Kategorie
370650	Želechovice nad Dřevnicí	15
545491	Želenice nad Bílinou	15
539866	Želenice u Slaného	15
533497	Želénky	14
770354	Železná Ruda centrum	15
770156	Železná Ruda město	15
770255	Železná Ruda-Alžbětín	13
554105	Železnice	15
565820	Železný Brod	13
535898	Želina	15
562769	Želivec	15
746537	Želvice	15
348847	Ženklaava	15
370759	Židlochovice	13
751651	Žihle	13
539536	Žichlínek	14
736256	Žichovice	13
552091	Žim	15
567503	Žireč	15
740159	Žirovice-Seníky	15
563205	Žitětín	15
561217	Živonín	15
746735	Životice	15
537696	Žižlice	15
759324	Žlábek	15
554238	Žlebské Chvalovice	15
554741	Žleby	15

Číslo dle SR 70	Název	Kategorie
554642	Žleby zastávka	15
760546	Žloukovice	15
733659	Žlutice	15
355727	Žulová	13

Číslo dle SR 70	Název	Kategorie
537696	Žiželice	15
759324	Žlábek	15
554238	Žlebské Chvalovice	15
554741	Žleby	15

Číslo dle SR 70	Název	Kategorie
554642	Žleby zastávka	15
760546	Žloukovice	15
733659	Žlutice	15
355727	Žulová	13

Annex "C"

Prices for the Use of infrastructure, financial penalties and incentives related to the use of allocated capacity

Part A

Prices for the Use of a Regional Track Operated by PKP CARGO INTERNATIONAL, a.s., by Train and the Conditions for Their Use

The price for using the rail transport route by train on the Milotice nad Opavou – Vrbno pod Pradědem regional track is for passenger and freight trains calculated according to the following formula:

$$C = S_1 \times L + (Q/1000) \times S_2 \times L \quad [\text{Kč}]$$

Where

$$S_1 = 9,07 \text{ Kč/trainkm}$$

$$S_2 = 0,00 \text{ Kč/1000 bruttotonkm}$$

L – train movement distance in kilometres rounded up to full kilometres

Q – gross train weight in tonnes as determined for the freight train as the sum of the weight of rail vehicles in the train and the weight of the load in tonnes rounded up to full tonnes

The cost of using the Milotice nad Opavou – Vrbno pod Pradědem regional rail route by train calculated according to the above formula is excluding VAT.

Část B

Ceny za použití regionálních drah provozovaných PDV Railway, a.s., jízdou vlaku a podmínky jejich uplatnění

Part B

Prices for Using Regional Railway Operated

by PDV Railway, a.s., by Train and the Conditions of Their Use

The price for using the railway transport route by train on the regional railway routes Sokolov – Kraslice and Trutnov hl. n – Svoboda nad Úpou is calculated for passenger and freight trains according to the following formula:

$$C = L \times C_{\text{nákladní1}} + L \times C_{\text{nákladní2}} \times Q/1000 + L \times C_{\text{osobní}} + L \times C_{\text{lokomotivní}} \text{ [Kč]}$$

where:

C	= the final cost of using a route by one train for a negotiated transport route;
C_{passenger}	= 13,76 CZK/pkm, the final price for the use of the railway transport route by one passenger train for an agreed transport route related to the provision of operation of the railway route (traffic management) and converted to the price per 1 pkm as the share of the price for part of running costs (traffic management);
C_{locomotive}	=13,76 CZK/pkm, the final price for the use of the railway transport route by one locomotive train for an agreed transport route related to the provision of operation of the route (traffic management) and converted to the price per 1 pkm as the share of the price for part of running costs (traffic management);
C_{freight1}	= 83,26 CZK/pkm, part of a component of the final price for the use of the railway transport route by one freight train for an agreed transport route related to part of running costs (traffic management) and converted to the price per 1 pkm as the share of running costs (traffic management);
C_{freight2}	= 55,50 CZK/1,000 tkm, part of the component of the final price for the use of the railway transport route by one freight train for an agreed transport route, related to a part of running costs (traffic management) and converted to the price of 1,000 tkm for the respective train type given as a share of the price for part of the running costs (traffic management) per thousand gross tonne kilometres;
L	= the length of the route the train travelled in kilometres rounded up to full kilometres
Q	= gross train weight in tonnes as determined for the freight train as the sum of the weight of rolling stock in the train and the weight of the load in tonnes rounded up to full tonnes.

Price for using the track does not include the cost of its allocation. Správa železniční dopravní cesty, státní organizace is the capacity allocator at regional railways run by PDV RAILWAY a.s.

The allocation of reserve capacity and own use of a route for movements directly conducting the diagnostics, measurement and maintenance of the railway infrastructure within the actions covered by the means for ensuring the operational availability of the railway is not priced.

The price for use of the railway by train is applicable to public and non-public transport and is determined excluding VAT. The rates for the use of the railway by train are equivalent to all Railway undertakers (hereafter "RU") and the same type of service.

Part C Prices for Utilisation of National and Regional Railways Operated by Správa železniční dopravní cesty, státní organizace, by Train and the Conditions for Their Application

I. The frame of the pricing of the use of the track by train – general information

I.1 Running of all trains on the Správa železnic's network is associated with the payment of prices for the use of the track by running a train.

I.2 All parameters of the pricing model for calculating train path prices must be in accordance with the applicable price regulations. The price model follows the principles of price regulation for acts related to the use of railway infrastructure within the minimum access package. Basic information on the principles on the basis of which the pricing model was created is the subject of Chapter 5 of the Network statement.

I.3 The calculation of prices for the use of the track by train may only include costs that meet the conditions of direct expenditure on the ensuring operability and operation of rail transport to the extent specified in the valid assessment of the Ministry of Finance. The price is constructed as a two-component with a separate calculation:

- a. for the train 's own running
- b. using passenger access roads.

In calculating the basic prices, the costs directly incurred in the operation of the railway were used, ie the wage costs for direct traffic management and the direct costs incurred for maintenance and repairs of the infrastructure, assigned to the individual price components using the train path. Details are given in Chapter V of this Annex..

I.4. For the purpose of determining the price for the use of national and regional railways, train travel means the running of one or more rolling stock, including special traction units, if it is organized as a train running within the meaning of the traffic regulations.

I.5 The parameters and application conditions of the price model for the calculation of prices for the use of track by train are binding for the railway operators Správa železnic and for all legal entities with which a contract was concluded on the operation of rail transport on the railway network owned by the Czech Republic. hereinafter referred to as RUs).

I.6 Prices in the context of this Annex "C" means prices excluding VAT.

II. Pricing model

II.1 The price for using the train path for a specific train is calculated according to the calculation formula given in Article II.3 below. In the case of the train's own running, which is affected by the different values of the individual components of the calculation formula, the calculation is performed separately for each calculation object sub-train carrying a certain combination of train number, train weight and ETCS value. The price for using the track by a particular train is therefore composed of as many sub-train prices as the number of times a component of the calculation formula has changed during the train's journey. The train does not serve to record the number of train stops or to calculate the price for access roads for passengers on a passenger train.

II.2 The price for the use of access roads for passengers in passenger trains (hereinafter the price for access roads) is the price for services provided within the minimum access package and forms a separate component of the regulated price for the use of the track by train. For the price of access roads, the Správa železnic provides all RUs with a service consisting in enabling their traveling clientele to access passenger trains.

II.3 Calculation formula for calculating the price using the train path

$$C_v = \Sigma C_s + C_{PK}$$

where:

C_v = price for using the track by train [CZK]

C_s = price for using the track by running one sub-train [CZK]

C_{PK} = price for the use of access roads for passengers in a passenger train [CZK]

$$C_s = (L * Z_{RP}) + (L * Z_I * M * P_x * K_{ETCS})$$

where:

L = subtrain travel length [km]

Z_{RP} = basic price for traffic management per unit of traffic output [CZK / km]

Z_I = basic price for maintenance and repairs of infrastructure per unit of transport performance [CZK / hr*km]

M = total train mass [t] (see Article III.2 of this Annex)

P_x = value of product factor P1 to P5

k_{ETCS} = ETCS mobile train stock coefficient

$$C_{pk} = \sum_{n=11}^{n=15} (Z_n^{pk} \times m_{pk} \times N_{zn})$$

where:

C_{pk} = price for access roads at railway stations and stops in the whole train route [CZK]

Z_n^{pk} = basic price for one planned stop of a passenger train for boarding and / or disembarking passengers at railway stations and stops of category "n" [Kč/zastavení*t]

m_{pk} = mass of the train for calculating the access price [t] (see Article III.3 of this Annex)

N_{zn} = planned number of passenger train stops for boarding and / or disembarking of passengers at railway stations and stops of category "n"

II.4 For the period of validity of the annual timetable 2023, the following basic prices per unit of transport capacity are assumed to apply:

Basic prices	Unit	Value for period from 11 December 2022 to 31 December 2022	Value for period from 1 January 2023 to 9 December 2023
Z_{RP}	Kč/trkm	0,00000	0,00000
Z_I	Kč/gtkm	0,07154	0,07306

The adjustment of the basic price from 1 January 2024 occurs in connection with the increase in the prices of supply works in the framework of ensuring repairs and maintenance of the railway infrastructure.

II.5 For the period of validity of the 2024 annual timetable, the following basic prices for access roads are assumed to be used:

Category of stations and stops for calculating prices for access roads „n“	Basic price Z_n^{pk} [Kč/stop*t] valid for 10. 12. 2023 až 31. 12. 2023	Basic price Z_n^{pk} [Kč/stop*t] valid for 1. 1. 2024 až 14. 12. 2024
11	0,12	0,07
12	0,03	0,20
13	0,06	0,04
14	0,02	0,05
15	0,04	0,07

III. Definition of individual components of calculation formulas

III.1 **The length of the sub-train running L [km]** is determined for the purpose of calculating the prices for the use of the track by the train running in relation to the topological data of transport points whose position on the line is stated to one decimal place in the KANGO network. For verification, RUs can use the DYPOD application, available on the Railway Operation portal (<https://provoz.spravazeleznice.cz/dypod>).

III.2 **The total train mass M [t]** used to calculate the train running price is the sum of the masses of all train vehicles, including the mass of passengers or freight, rounded up to the nearest tonne. In the case of trains with product factor P1 - passenger transport, heavier than 405 tonnes, the value 405 tonnes shall be used for the calculation.

III.3 **Train mass for the calculation of the price using passenger access roads m_{pk} [t]** is the total mass of train M (see Article III.2 of this Annex) less the mass of active traction units

without the possibility of passenger transport according to REVOZ and rounded for whole tons up. The upper train weight limit of 405 tonnes does not apply in this case.

III.4 **Product factor P_x** is a factor that takes into account market segmentation and the extent of support in the relevant segment. The following product factors are introduced in the pricing model:

- P_1 – Passenger transport
- P_2 – Non - specific freight transport
- P_3 – Freight transport within the single-load wagon system
- P_4 – Combined freight transport
- P_5 – Freight transport - non-standard trains

The conditions for using the corresponding product factor in calculating the price for a specific train are the subject of Chapter V. of this Annex. Each train is assigned a single product factor, mutual combination is excluded.

Individual product factors take on the following values:

Product factor P_x

Product factor	Value
P_1	1,00
P_2	0,85
P_3	0,20
P_4	0,55
P_5	2,00

III.5 Coefficient of an Active Drive Vehicle in a Train with ETCS K_{ETCS}

Due to the fact that it is a matter of supporting the introduction of the safety device on the widest possible scale, trains with active driving vehicles equipped with this device are priced favorably even when traveling on track sections without the stationary part of the ETCS system. The price discount does not apply to driver cars. The amount of benefit in the price model takes into account the fact that, in accordance with Directive 2012/34/EU, additional support from the state budget is provided to owners of drive vehicles with the mobile part of ETCS. The price advantage is assigned to every train in which at least one active driving vehicle is equipped with a mobile part of ETCS, Level 2 or higher and which has encryption keys activated on the RBC side enabling driving under the supervision of ETCS. The amount of the price discount for the train does not change with the number of vehicles included in it that meet the specified criteria. In order to assign a more favorable value of the coefficient belonging to vehicles with a mobile part of ETCS, Level 2 or higher, the decisive entry in IS REVOZ (checked status " K_{ETCS} Price for using the track by train" in the tab "Vehicles"), which will be carried out by the railway operator for each individual vehicle after meeting the above-mentioned conditions. The new value of the coefficient affects the calculation of the train price from the date of entry of the information into IS REVOZ. The entry of information about the fulfillment of the criteria into IS REVOZ does not have retroactive effect. A carrier who operates a vehicle that meets the above conditions can check the right to be assigned a more favorable value of the coefficient in IS REVOZ.

Coefficient of an Active Drive Vehicle in a Train with ETCS (Level 2 or higher)

Equipment of a Drive Vehicle with ETCS Level 2 or Higher	Value
Non-equipped drive vehicle	1,00
Equipped drive vehicle	0,90

III.6 The planned number of train stops for boarding and / or disembarking of passengers N_{zn} decisive for the calculation of the price for access roads corresponds to the parameters of the allocated train path.

IV. Operating and Technical Conditions Affecting the Calculation of Prices

IV.1 Mode of showing performance parameters for the calculation of the price for using the railway by train is governed by SŽ Is 10.

IV.2. The cost of using the railway by train corresponds to its actual composition, as determined by the information systems or train control, performed by Správa železnic. The source of information about the vehicles included in the train is data obtained by the RU in IS ComposT in accordance with the rules specified in the SŽ Is 10 regulation.

IV.3 In the case of calculating the price for the use of access roads for passengers in a passenger train, the mass mpk serves as a surrogate benchmark for differentiating the charging of each planned stop of a passenger train according to its occupancy.

IV.4. For calculating the resulting prices for using the railway by train, the actual travelled track is decisive and, in the case of a passenger train, the planned number of stops at the boarding and / or disembarking points of passengers. In the event that a train has been on a diversion route for reasons on the part of Správa železnic, Správa železnic shall proceed in accordance with the provisions of Commission Implementing Regulation (EU) 2015/909, Article 5, paragraph 4.

IV.5 For the purposes of determining the price for the use of a track by train, a passenger train is a train to which the product factor P1 has been assigned in the information system for calculating the price for the use of a track (hereinafter referred to as IS KAPO). A freight train, for the purposes of determining the price for the use of a track by a train, means a train to which one of the product factors P2, P3, P4 or P5 has been assigned in IS KAPO. The basic criterion for the admissibility of assigning a product factor to a train is the type of train corresponding to the breakdown according to the regulation SŽ D1 ČÁST PRVNÍ and listed in the header of the relevant train in IS ISOŘ. The carrier is responsible for the correctness of the train type in the application for allocation of track capacity. If, during performance processing in IS KAPO, its operator discovers that the combined train (Sv) traveled the entire route in the composition of only a driving vehicle (with the exception of a motor vehicle or a traction unit), its product factor will be changed to P₂.

IV.6 All railway stations and stops on the Správa železnic's network are divided into 5 categories marked 11 to 15 for the purpose of calculating the price for access roads. The categorization of railway stations and stops is performed according to their equipment with access roads.

The criteria for the division of railway stations and stops into individual categories, the list of categories and the affiliation of railway stations and stops to individual categories are the subject of Table C of Annex "B" to this Railway Declaration.

In some railway stations, passenger access to the train is enabled not only through the access roads of the Správa železnic, but also through the service facilities operated by České dráhy, a.s. The list and description of these service facilities, the method of ordering the services provided through them and the scope of charging are published on the website of České dráhy, a.s.

http://www.ceskedrahy.cz/nase-cinnost/ostatni-cinnosti-a-servis/zarizeni_sluzeb/-29800/.

Costs for service facilities operated by České dráhy, a.s. are not included in the costs on the basis of which the Správa železnic has set a price for the use of access roads for passengers on a passenger train (see Article VI.4 of this Annex). The equipment of the railway station with service facilities operated by České dráhy, a. S. Has no effect on the classification of the railway station into the relevant category within the meaning of the first and second paragraphs of this Article. The Správa železnic is not responsible for the accuracy and updating of information on the nature, scope and prices of services published on the website of České dráhy a.s.

V. Conditions for Calculating the Final Price for Using the Railway by Train Using Product Factors P₃, P₄ or P₅

In order to support the development of selected segments of the market in the railway freight traffic, Správa železnic announces different prices for the use of the railway by train, which are available in an equal and non-discriminatory way to all national and regional railway RUs operated by Správa železnic. For trains that meet the conditions below, the resulting price shall be calculated using product factor P₃ or P₄.

V.1 Conditions for the conversion of the basic price for use of the railway by train by the value of product factor P₃ – freight transport within the collection and delivery system of individual train shipments

- Product factor P₃ shall be used for the following types of freight trains from the annual timetable and its regular changes or introduced on the basis of a positively assessed request for long-term ad hoc allocation of rail capacity if these trains are part of the collection and delivery system of the individual train shipments of the RU that asked for the assignment of product factor P₃ :
 - a) regular handling and siding trains,
 - b) selected regular national freight trains for the transport of individual wagon loads between train-making stations on infrastructure operated by Správa železnic in which the train is reprocessed,
 - c) selected regular international freight trains for the transport of individual wagon loads between train-making stations where the train is reprocessed,
- The assignment of product factor P₃ for specific trains must be discussed by the RU in writing with Správa železnic's Commercial and Contractual Relations Department.

In the case of trains according to the annual timetable and its changes, the RU submits a list of trains stating their number and starting and destination points on the Správa železnic network..

In the case of individual ad hoc applications with the product, the long-term request of the RU shall indicate either a list of trains indicating their number (if already assigned) or a list of registration numbers of requests for allocation of individual railway capacity. In both cases, it indicates the starting point and final destination in the Správa železnic network.

Each train must include information demonstrating its competence for the RU's collection and delivery system (this may include an extract from the train-making plan, an overview of continuity of trains in the freight and delivery system of individual shipments, resource information and load determination at stations where the train is supposed to manipulate, etc.). Only trains whose inclusion in the system is evidenced by the mutual continuity of trains of the same RU are considered to be part of the carrier's fixed pickup and delivery system. The list must be sent by the RU to O5 Správa železnic in deadlines corresponding to the dates of submission of applications for the track capacity allocation (Chapter 4.5.1.5, 4.5.1.6 or the second paragraph of Chapter 4.5.3 this Network Statement). The actual assignment of the track capacity to the respective train is not a representation of the Správa železnic's consent with the assignment of product factor P₃.

If the system of internal communication of the infrastructure manager does not give the approval of the department of trade and contractual relations of Správa železnic with the assignment of the product factor P₃, the applications will be rejected by the infrastructure capacity allocator.

- Track numbers of trains according to the annual timetable, or changes thereof, which are, according to the negotiated list, intended for trains with product factor P₃, may not be used by the RU for routes of other relations. If the route number according to the negotiated list has been used by the RU for another relation, the RU loses the entitlement to product factor P₃.
- Application of product factor P₃ is not permissible for trains which ran composed of only one or more of drive vehicles.
- Application of product factor P₃ is not permissible for trains for which the train composition report in the IS ComposT (Information System of Composition of Trains) has not been acquired.

V.2 Conditions for conversion of the basic price for the use of the railway by train by product factor P₄ – combined freight traffic

- Product factor P₄ will be used for freight trains, composed exclusively of driving vehicles and towed vehicles for combined transport transport units loaded with these units or empty.
- • When ordering track capacity for a combined transport train, the carrier enters the product factor P₄ in the application.
- • The application of the product factor P₄ is not permissible for a train that was driven by only one or more driving vehicles. If it is a train where part of the allocated route used by it is the journey of an entering or departing driving vehicle, the product factor P₄ can be kept for this train in the event that the proportion of journeys without load on the total used length of the allocated route is lower than 50%.
- • The application of the product factor P₄ is not permissible for trains for which a train composition report has not been taken in IS ComposT.

V.3 Application of product factor P₅ freight traffic – non-standard trains

From the point of view of assigning the corresponding product factor, trains run for testing rail vehicles at a speed higher than line vehicles or vehicles with the axle weight greater than that prescribed for the section of the track are considered non-standard, or if driving requires special transport measures or non-standard operations (e.g. extra measurement or check of the track, guarding of crossings, etc.). The calculation of the price for a non-standard train is carried out by applying product factor P₅ freight traffic – non-standard trains.

VI. Costs used in the calculation of basic prices

VI.1 The costs incurred in 2021 were used to calculate the prices valid for the period from 1.1.2024 to 31.12.2024.

VI.2 Direct costs of traffic management used to calculate the basic price of Z_{RP}

The wage costs of operating employees in the following positions are used to calculate the basic price:

- Station dispatcher,
- railway operator,
- line dispatcher,
- operational dispatcher,
- Chief Dispatcher.

The part of wage costs that was paid for the activities of operating employees at the time when they did not perform actions directly related to the running of trains is excluded from the calculation.

VI.3 Direct costs of infrastructure maintenance and repairs used to calculate the base price of the Z_i

The costs of maintenance and repairs of the railway superstructure and substructure directly related to the train running are used to calculate the basic price. These are mainly costs directly related to operation and maintenance:

- rails (assembly, disassembly and replacement of rails, welding of rails, repair of rail contact, replacement of small rails),
- sleepers (repair, disassembly, replacement, equipment, sleeper lining),
- switches (cleaning and lubrication, grinding).

The costs used to calculate the price for the use of the train run do not include any costs for which it is not currently possible to prove by measurement or otherwise a direct link to the train run. In particular, these are the costs associated with the operation and maintenance of:

- bridge structures,
- tunnels,
- security equipment,
- track mechanisms,
- crossings,
- platforms,
- traction line,
- dispatch buildings.

VI.4 Direct costs for the operation of access roads for passengers on the passenger train used to calculate the basic price Z_n^{pk}.

To calculate the basic price, the costs directly incurred for the operation of access roads, listed in point 6 of the Annex to Decree No. 76/2017 Coll., On the content and scope of services provided by the RU to the railway operator and the operator of the service facilities, are used. In the conditions of the network operated by the Správa železnic, these are costs directly related to the operation, maintenance, lighting and cleaning:

- platforms, including their roofing, lighting and equipment with benches, seats, storage areas for hand luggage and waste bins,
- crossings, underpasses, overpasses, footbridges, corridors, staircases and pathways intended for passengers to access the platform, including their roofing and lighting,

- lifts, escalators, elevators and means to ensure barrier-free access to the platform,
- signboards with station names and train directions.

The costs used to calculate the price using access roads do not include any costs associated with:

- indoor or outdoor areas and facilities of railway stations and stops that do not serve for passenger access to the platform,
- car parks, boarding and alighting points for means of transport by which passengers arrive before boarding the train or leave after leaving the train,
- areas and equipment for storing bicycles,
- fire and safety protection equipment,
- sanitary facilities for passengers,
- information boards and equipment beyond the provision of basic orientation on arrival and departure from platforms,
- premises and facilities for luggage storage or handling,
- mobile lifting devices designed to allow barrier-free movement between the platform and the train,
- devices for WIFI data transmission,
- any other premises and facilities that are charged outside the minimum scope and content of the services

VII. Processing Information in the IS KAPO Computational System and Approval of Invoiced Performances and Prices for Use of the Railway by Train

VII.1 Calculation of prices for the use of the railway by train is performed through the Správa železnic IS KAPO computational system for all trains that ran in the billing period under review. The initial supporting materials are the data on the ordered train route; the timetables issued the parameters of the actual train running and the planned number of passenger train stops for passenger get-on and get-off. These documents are imported to the IS KAPO from operational information systems (details are contained in SŽ Is 10). The acquirer (RU) is responsible for accuracy of the data entered into the Správa železnic computational system, including the application requirement of product factor P₃ or P₄.

VII.2 Reconciliation of invoiced services and prices for the use of the track by the train, including the price for the use of access roads between the Správa železnic and the RU, is performed via the IS KAPO web application. Details are given in the SŽ Is 10 regulation. With a larger volume of data, during the calendar month, in parallel with the agreement on the website, they can be checked via a work delivery note in MS Excel format with a periodicity agreed between IS KAPO staff and an authorized RU.

VII.3 The settlement of comments in the IS KAPO web application is considered to be a formal approval of invoiced services and prices prior to the authorization of data and the preparation of documents for the issuance of an invoice. By 24:00 on the 10th day after the end of the invoiced month, the RU either agrees the performances and the prices, or is obliged to state in writing the reasons for which it refuses to do so. If the Správa železnic insists on the correctness of the proposed documents for invoicing, the procedure of both contracting parties after issuing and sending the invoice is governed by generally applicable legal regulations.

VII.4 After the deadline set out in Article V.3, the IS KAPO operator authorizes the data of the relevant invoicing period and enters the information system with an instruction to prepare a monthly summary of invoiced prices, broken down by individual product factors assigned to trains of the relevant RU in the invoicing month. The summary also includes the price for access communications. The monthly summary is sent to the RU as an annex of the invoice.

Part D

Penalties for Unused or Denied Allocated Capacity of the Nationwide and Regional

Railways Operated by Správa železniční dopravní cesty, státní organizace

I. General Information and Conditions for the Determination of Penalty for Unused or Denied Allocated Capacity

I.1. The reasons on the basis of which the Správa železnic charges the RU a penalty for unused allocated capacity and the applicant a penalty for relinquished allocated capacity are given in chapter 5.6.3 and 5.6.4 of this Network Statement.

I.2 The Správa železnic monitors in its information systems the extent of the unused allocated capacity of each of the RU and the extent of the renounced allocated capacity of each of the applicants to whom the capacity was allocated. If it finds that the RU has not used or that the applicant has renounced the capacity for reasons according to Article I.1, it will send the RU or the applicant for review an overview of the unused or renounced capacity from IS KAPO containing details of individual routes, including a calculation of the corresponding amount of the penalty that it intends to invoice. Any objections based on substantive reasons may be made by the RU in the case of unused capacity or the applicant in the case of relinquished capacity within 5 working days of delivery of the overview.

II. Invoicing a Penalty for Unused or Renunciation Allocated Capacity

The Správa železnic invoices RU for penalties for not using allocated track capacity and applicants for sanctions for renouncing allocated track capacity on a quarterly basis (for details, see Article 5.9.3). Attached to the invoice is a Summary overview of the penalty for unused or relinquished allocated track capacity for the individual months in which the penalty is imposed. Invoices the applicants for penalties for unused or renunciation of allocated railway capacity on a quarterly basis (for details see chapter 5.9.3). Attached to the invoice is a summary of the penalty for unused or renounced allocated capacity for each month in which the penalty is imposed.

III. Calculation of the penalty

The Správa železnic, driven by an effort to motivate the RU to renounce capacity even less than one month before the train runs, announces incentive coefficients of penalty for unused or waived allocated capacity in the amount specified in Chapter V. The deadlines specified in Chapter V. are calculated in hours. minutes of departure from the first point on the Správa železnic network according to the assigned timetable. The amount of the sanction for unused or waived allocated capacity is determined by the product of the route length in km (to 1 decimal place) and the sanction rate in CZK / km according to Chapter IV. and the relevant coefficient according to the capacity waiver referred to in Chapter V. (the coefficient is used only in the case of a penalty for canceling allocated capacity):

$$S = M_x \times L \times N \quad [\text{CZK}]$$

- kde: **S** the resulting amount of the penalty for unused or denied capacity
M_x incentive coefficient penalty for canceled allocated capacity (see Chapter V.)
L the length of train route according to each category of the railway (see Part C, Article II.3)
N Rate of penalty for unused or denied allocated capacity (see Chapter IV.)

IV. Rates of Penalties for Unused or Denied Allocated Capacity

Rates of Penalties for Unused or Denied Allocated Capacity

Rate	Assignment	CZK/1 trainkm valid for from 10. 12. 2023 to 31. 12. 2023	CZK/1 trainkm valid for from 1. 1. 2024 to 14. 12. 2024
N	Pasanger and freight transport	0,60	0,60

. Incentive coefficients of the penalty for cancelation the allocated capacity

Incentive coefficients of the penalty for cancelation the allocated capacity

Coefficient	Capacity denial deadline	Value
M ₁	30 and more days before the ride	0,00
M ₂	Less than 30 but 7 and more days before the ride	0,25
M ₃	Less than 7 but 3 and more days before the ride	0,50
M ₄	Less than 3 days before the ride	1,00

Annex "D"

Form for holders not being in possession of a valid licence:

PROHLÁŠENÍ O VYUŽITÍ KAPACITY DRÁHY

Žadatel:

Identifikační údaje	Název:
	Adresa sídla:
	IČ:

Specifikace žádosti o trasu:

Manažer infrastruktury	Správa železnic, státní organizace Praha 1 - Nové Město, Dlážděná 1003/7, PSČ 110 00 IČ: 70994234	Období jízdního řádu	
-------------------------------	---	-----------------------------	--

Číslo smlouvy s žadatelem	Výchozí stanice	Cílová stanice	Kalendář dnů jízdy

Určený dopravce:

Identifikační údaje	Název:
	Adresa sídla:
	IČ:
	Číslo dopravce (kód RICS):

Prohlášení:

Výše jmenovaný určený dopravce tímto prohlašuje, že kapacitu dráhy, která bude přidělena na základě žádosti o trasu dle specifikace uvedené v tomto prohlášení, skutečně využije a bude vykonávat práva a povinnosti dopravce dle platného prohlášení o dráze vydaného výše uvedeným manažerem infrastruktury.

Za žadatele		Za určeného dopravce	
Jméno a příjmení:		Jméno a příjmení:	
Datum:		Datum:	
Podpis:		Podpis:	

Annex "E"

FORM FOR NATIONAL PATH STUDIES AND REQUESTS

Vedoucí dopravce		č.	Nákladní doprava		Osobní doprava	
------------------	--	----	------------------	--	----------------	--

Období jízdního řádu		Název jednání, datum, místo	
----------------------	--	-----------------------------	--

Datum :	
---------	--

Studie trasy	
--------------	--

Žádost o trasu	
----------------	--

Nabídka trasy	
---------------	--

Detailní název příloh

Typ žádosti	
Nová žádost	
Změna v průběhu konstrukce jízdního řádu	

Trasa vlaku

Komentář

Část dopravců

1. Požadované časy a parametry vlaku:

Druh vlaku (kombinovaná doprava, jednotlivé zásilky):

Číslo vlaku nebo jiná identifikace:

Jméno vlaku (existuje-li):

Kalendář jízdy (specifikace dnů od 1 do 7 a období platnosti)

2. Podrobný popis požadované trasy

Směr vlaku

Z:

Do :

Pč.	Č. vlaku	Čas příjezdu	Čas odjezdu	Stanice/dopr. bod	Parametry vlaku:	Jméno žadatele pro každý úsek trasy
					Max rychlost (km/h) Celk. Délka (včetně HV) Hmotnost(t) Nápr. tlak Hmotnost/metr (t) Řada HV Průjezdny průřez Způsob brzdění Brzdící (%) Přemostění záchranné brzdy Druh zastavení (Úkony, doba pobytu ...)	

3. Podrobnosti složení vlaku

Číslo vlaku nebo jiná identifikace

Čelo vlaku z

PČ	Žadatel	Pozn.	Řada vozu	kód	Poř. Číslo	Číslo železnice	Z vlaku	Předchozí trasa	Z	Do	Navazující trasa	Na vlak	EWP č.

Poznámky

4. Časy pro přímé vozy - pouze pro osobní vlaky:



Přímé vozy z / do					Místo	Přímé vozy z / do					Odpovědný žadatel	
Číslo vlaku	Dny jízdy	Poznámky	Příjezd	Odjezd		Číslo vlaku	Dny jízdy	Poznámky	Příjezd	Odjezd		

5. Požadované přípoje:

Pro vlak	do	Přípoj pro	Komentář

Kontaktní údaje**Žadatelé:**

Odpovědní žadatelé (dopravci) za koordinovanou žádost:

Žadatelé (Kontaktní osoba: jméno, číslo telefonu, e- mail)	Z	Do	Podpis	E-Mail

Pozn.: Pouze žádosti podepsané (koordinované) všemi zúčastněnými žadateli obdrží harmonizované mezistátní odpovědi.

Provozovatelé infrastruktury (IM):**Potvrzení přijetí žádosti odpovědným provozovatelem infrastruktury****Název vedoucího IM:**

Provozovatel infrastruktury (Kontaktní osoba: jméno, číslo telefonu, e- mail)	Z	Do	Podpis	E-Mail

Potvrzení koordinované odpovědi dané žadatelům (Zúčastnění IM)

Provozovatel infrastruktury (Kontaktní osoba: jméno, číslo telefonu, e- mail)	Z	Do	Podpis	E-Mail

Kontaktní pouze OSS pro písemnou žádost

Provozovatel infrastruktury (Kontaktní osoba: jméno, číslo telefonu, e- mail)	
---	--

Annex "F"

Train Radio Devices

1 Basic and substitute railway radio communication, emergency communication

1.1 Train radio devices³⁾ on railways operated by Správa železnic are used as a basic or substitute radio communication or emergency communication.

1.2 A basic radio connection means such a radio connection on the track, which on a track equipped with the relevant radio infrastructure enables with the prescribed quality⁴⁾ (both full-fledged voice communication between the train driver and dispatcher⁵⁾) and between train drivers, as well as in the case of GSM-R, SRD and some SRV networks (if they are equipped with selective dialing) as well as data communication between mobile and fixed radio devices (working or unattended).

1.3. Substitute radio communication is a radio communication that allows the driver to communicate with the dispatcher in the area controlled by the driver. Only specified types of radio equipment may be used for substitute radio communication. The type of radio communication to be used as a substitute radio communication shall be determined by the railway operator individually for each route, taking into account the level of coverage of the relevant radio sections of the track by a usable signal. The substitute radio communication must not be permanently used instead of the basic radio communication.

1.4. Emergency track link means any voice link, including an emergency radio link, which allows the driver to communicate with the dispatcher of the relevant control area in the event of a breakdown or abnormality during the driving or special driving vehicle (hereinafter referred to as "traction vehicle"); this only until the vehicle arrives at the destination train station. Emergency voice communication must never be used as a permanent replacement for basic or substitute radio communication. When using emergency communication, the maximum train speed is limited to 100 km/h.

1.5 Table 01 TTP is the relevant document identifying the current train radio device used as basic or substitute radio communication or, the emergency communication on individual lines equipped with the relevant infrastructure. For convenience, the equipment of individual lines with specific train radio device is also listed in the Network Statement, map M10.

1.6 Technical specifications of train radio devices and the principles for their implementation on railways operated by Správa železnic are set out in the *"SŽDC Directive No 35 setting technical specifications for radio equipment units and principles of their preparation and implementation on the infrastructure owned by the state,"* as amended.

³⁾ See Section 71 of Decree No. 173/1995 Coll., which issues the Railways Traffic Rules.

⁴⁾ For GSM-R defined by UIC EIRENE, Functional Requirements Specification (FRS) version 7.3.0, March 2012, and System Requirements Specification (SRS) version 15.3.0, March 2012 (at the time of issue of this Statement), for SRV determined by UIC Recommendation No. 751-3.

⁵⁾ The term "dispatcher" is used in the text as a common name for employees with professional competence in organising and managing rail transport. If there is a need to clearly define the employees, definitions according to SŽDC Code D1 are used.

2 Used Train Radio Devices

2.1 Mobile Radio Network in GSM-R System

Mobile Radio Network in GSM-R

Provozovatel	Prezentace sítě na mobilním terminálu		
Správa železnic, státní organizace	GSM-R CZ	nebo	230-98

2.1.1 The GSM-R system provides voice communication and data transmission between mobile devices (dispatching terminals, automated data radio devices etc.) and fixed stations (dispatcher stations, workplaces by station dispatchers, etc.) and communication to other electronic communication networks (railway telephone network, public fixed or mobile networks, etc.).

2.1.2 The GSM-R system operates in the 900 MHz frequency band and is based on the GSM public mobile telephone network standard with additional specific railway functions according to UIC that are part of the EIRENE technical documentation. The system is interoperable as part of the Control-Command and Signalling subsystem, Class A ⁶⁾.

2.1.3 On the Správa železnic website <https://www.spravazeleznic.cz/> dodavatele-odberatele/zajisteni-provozuschnosti-drahy/radiove-site, the following is to be found:

- general operating and business conditions of non-public electronic communication services provided in the non-public mobile telephone network GSM-R Správa železnic,
- procedure for ordering, issuing and verifying SIM cards,
- a list of mobile terminals approved for use on railways owned by the Czech Republic and their operation in the GSM-R system,

as well as other operational and organisational information.

2.1.4 Lines equipped with GSM-R system are indicated using signals "Prepare a GSM-R radio device for registration"⁷⁾ which is usually located close to the entry warning signal of the operating control point equipped with GSM-R system using the signal "Start of the radio system"⁸⁾, which is placed at the point where the GSM-R radio equipment is to be registered and also on national borders. At the branches of lines equipped with a GSM-R system that are not equipped with another track radio system (TRS systems or SRV radio network) are indicated using the signal "End of GSM-R radio system"⁹⁾.

2.1.5 The envisaged procedure for the construction of GSM-R system is published on Správa železnic website Správa železnic – <https://www.spravazeleznic.cz/> follow „Dodavatelé/Odběratelé - Zajištění provozuschopnosti dráhy - Rádiové sítě“.

2.1.6 On some lines, the so-called national roaming on a public GSM mobile network of an operator may be used to connect mobile devices (equipped with GSM-R terminals) with fixed stations. In such a case, adequate and reliable coverage of the operating control points and lines with radio signal is not guaranteed and some functions of GSM-R system may not be available, in

⁶⁾ Decree No. 352/2004 Coll., on operational and technical interoperability of railways and railway vehicles; Directive 2008/57/EC of the European Parliament and of the Council on the interoperability of the rail system within the Community and the technical specification for the interoperability constituents of the Control-Command and Signalling subsystem according to Commission Decision 2006/679/EC, as amended by Decisions 2006/860/EC, 2007/153/EC, 2008/386/EC, 2010/79/EC and 2012/88/EC.

⁷⁾ See Article 146 of Správa železnic internal Regulation SŽ D1 ČÁST PRVNÍ „Dopravní a návěštní předpis pro tratě nevybavené evropským vlakovým zabezpečovačem“..

⁸⁾ See Article 146 of Správa železnic internal Regulation SŽ D1 ČÁST PRVNÍ „Dopravní a návěštní předpis pro tratě nevybavené evropským vlakovým zabezpečovačem“..

⁹⁾ See Article 146 of Správa železnic internal Regulation SŽ D1 ČÁST PRVNÍ „Dopravní a návěštní předpis pro tratě nevybavené evropským vlakovým zabezpečovačem“..

particular the emergency call (REC – *Railway Emergency Call*), *Group Call* and *LDA (Location Depending Addressing)*).

2.1.7 List of foreign operators of GSM-R systems with which agreements on network interconnection and international roaming are concluded at the date of issue of this Statement:

Seznam zahraničních provozovatelů systémů GSM-R

Provozovatel	Indikace sítě na terminálu	
Deutsche Bahn AG, DB-Netz, Německo	GSM-R D	262-10
Österreichische Bundesbahnen, Rakousko	GSM-R A	232-91
ProRail, Nizozemí	GSM-R NL	204-21
Železnice Slovenskej republiky, Slovensko	GSM-R SK	231-99
Maďarské železnice MÁV, Maďarsko	GSM-R HU	216-99
Rete Ferroviaria Italiana (RFI), Itálie	GSM-R I	222-30
SŽ Infrastruktura, Slovinsko	GSM-R SI	293-10
INFRABEL, Belgie*)	GSM-R-B	206-2
PKP - Polskie Linie Kolejowe, Polsko*)	GSM-R PL	260-9

*) Ode dne vyhlášení

The current list of roaming partners can be found on Správa železnic website – <https://www.spravazeleznic.cz/dodavatele-odberatele/zajisteni-provozuschnosti-drahy/radiove-site>.

2.1.8 In the infrastructure part of the GSM-R CZ radio network, the national application "STOP function in the GSM-R system" is implemented according to SŽDC technical specification No TS 3/2014-S, enabling the railway operator to activate the remote stopping of driving vehicles in the selected controlled area vehicle radios are fitted with an active GSM-R radio network SIM card (with the appropriate profile). In such a case, the stop will take place either automatically (if the vehicle radio station is connected via the locomotive adapter to the main valve of the continuous braking system), or by the driver, who will ensure that the train stops immediately himself. In the event that the vehicle radio station is registered in the public GSM mobile phone network of an operator as part of so-called national roaming (see no. 2.1.6), the use of the "STOP function in the GSM-R system" is not possible.

2.1.9 The conditions and specifications for the use of the CZ GSM-R network are listed in the current version of the "GSM-R Operating Regulations", which is stored on the Railway Operation Portal in the " Rádiový provoz " folder.

.2 Track Radio System

2.2.1 The SRD system provides voice communication of track dispatcher, employee of the RU or other persons involved in control and organisation of rail transport and its operation with the engine driver of the traction vehicle as well as the transmission of coded information (commands, reports).

2.2.2 The SRD system respects the essential functions resulting from the relevant provisions of UIC Recommendation 751-3 and operates in the 450 MHz frequency band. The system is interoperable as part of the Control-Command and Signalling Subsystem, Class B⁴⁾.

2.2.3 The SRD system channel groups used on the track are indicated using a signal "Switch Channel Group"¹⁰⁾ that is placed at the location where the vehicle radio station is operated to change the channel group used or to change the radio system (from GSM-R or SRV) to SRD.

¹⁰⁾ See Article 146 of Správa železnic internal Regulation SŽ D1 ČÁST PRVNÍ „Dopravní a návěstní předpis pro tratě nevybavené evropským vlakovým zabezpečovačem“..

Branches of lines equipped with a SRD system that are not equipped with another track radio system (GSM-R systems or SRV radio network) are indicated using the signal "End of the analog train radio system"¹¹⁾.

2.2.4 On the Správa železnic web site <https://www.spravazeleznic.cz> (follow Dodavatelé/Odběratelé - Zajištění provozuschopnosti dráhy - Rádiové sítě), there is list of vehicle radios for which permission has been given to use the product on a railway owned by the Czech Republic and their operation in the SRD system. Appropriate radio stations, including documentation of their installation into existing vehicles, are subject to approval as a change to a rail vehicle.

2.2.5 The SRD vehicle radio can also be equipped for 150 MHz radio communications (for radio operation on other lines or local radio networks).

2.2.6 If necessary (e.g. implementation of remote control of security equipment, etc.) and temporarily (until the establishment of the GSM-R network), the SRD system can be built or supplemented on other lines as well - a notice indicating the effective date will be published by the Správa železnic on the Railway Operation Portal at the latest three months in advance.

2.2.7 The SRD radio network may only be used on the basis of the " Oprávnění k využívání kmitočtů a sítí (OVKS)" issued by the Centrum telematiky a diagnostiky.

2.2.8 The current versions of the " Provozní řád SRD " are stored on the Railway Operation portal in the " Rádiový provoz " folder.

2.3 Simplex Communication in the 150 Mhz Band

2.3.1 The simplex connection system in the 150 MHz band provides radio communication on selected lines (usually regional lines) between the dispatcher and the driver within range of the base radio station located in the relevant transport station or line (SRV train radio network) as well as communication of employees involved in railway operation. traffic on local radio networks (MRS). The system is not interoperable.

2.3.2. 2 For local radio networks (MRS), the system provides coverage of selected traffic by radio signal via base radio stations, coverage of adjacent line sections is not guaranteed for these networks. For train radio networks (SRV), coverage of traffic and adjacent track sections is provided in accordance with Směrnice č. 35 (Technické specifikace vlakových rádiových zařízení).

2.3.3 The following radio stations are used in the railway infrastructure:

- selective voice-frequency calling for train → station dispatcher direction and voice calls towards train, or
- voice calls of any participant.

2.3.4 Simplex frequencies used on the line are indicated using the signal "Switch Channel Group"⁸⁾. Branches of lines equipped with the SRV system that are not equipped with another track radio system (GSM-R or SRD systems) are indicated using the signal "End of the analog train radio system"⁹⁾.

2.3.5 Simplex communication systems SRV in the 150 MHz band are newly set up for rail traffic control on the respective route only exceptionally and only in justified cases.

2.3.6 In the railway operation, local 150 MHz simplex radio networks are also used to control certain technological processes (shunting control, vehicle inventory, wagon examination, track

¹¹⁾ Viz čl. 146 předpisu SŽ D1 ČÁST PRVNÍ „Dopravní a návěstní předpis pro tratě nevybavené evropským vlakovým zabezpečovačem“.

maintenance and repairs, etc.). This communication is indicated here for the sake of completeness and is established as required either by the railway operator or by the individual rail transport operators.

2.3.7 Radio equipment in the 150 MHz band operating at a 25 kHz channel spacing may not be used in the Czech Republic.

2.3.8 Simplex radio networks (SRV and MRS) in the 150 MHz band may be used only on the basis of the Oprávnění k využívání kmitočtů a sítí (OVKS) issued by the Centrum telematiky a diagnostiky.

2.3.9 The current versions of the " Provozní řád SRV " are stored on the Railway Operation portal in the " Rádiový provoz " folder.

3 Track Access Conditions

3.1. Traction vehicles that are being moved on a track equipped with an infrastructure part of a train radio system (GSM-R system, SRD system or SRV radio network) shall be equipped with a terminal enabling basic radio communication both for voice communication between the engine driver and persons involved in the control and organisation of rail transport, as well as for the bi-directional transmission of relevant signals, commands, messages or data between the railway infrastructure and the traction vehicles, i.e. a fully compatible and cooperative terminal while on track and in traffic of all functions with the infrastructure part of the train radio equipment used.

3.2 On lines where rail transport is organised and controlled according to Správa železnic Regulation D4 and on which a specific technical facility (hereinafter referred to as "radio-block"¹²) is installed, the traction vehicles must be equipped with a terminal ensuring full communication and cooperation of the traction vehicle with the radio block from the date of putting the radio block into permanent operation.

3.3 If a mobile phone (GSM-R radio network) or a portable radio (SRD or SRV radio systems) are temporarily used on a traction vehicle (SHV) as a terminal, such a terminal must be connected to a fixed external antenna of the traction vehicle, the main power supply must be provided from the recharged on-board battery of the traction vehicle and the terminal must operate at a high-frequency power of 8 W in the GSM-R system, 5 to 10 W in SRD or SRV radio networks, respectively. Without a communication to a fixed external antenna and a main HV (SHV) power supply, the GSM-R mobile phone or a portable radio station is considered to be an emergency radio communication only (see Decree No. 173/1995 Coll., Section 71(4)).

3.4 A traction vehicle (SHV) whose radio equipment does not allow basic radio communication on the route where the vehicle is being moved (e.g. due to equipment failure, infrastructure repairs, the lack of equipment due to an exceptional event etc.) must be provided with a means of enabling substitute radio communication (if set up) emergency radio connection or emergency communication. The operator (RU) must always provide information on the equipment of the driving vehicle with the appropriate type of radio connection, including an emergency connection, in the IS, at the latest before the departure of the train from the starting station and also at each change of driving vehicle during the train's journey.

3.5 If a basic radio connection cannot be established from the traction unit, the driver must inform the relevant dispatcher or dispatcher (specified in the Provozní řád of the relevant radio network) of the range of existing train communication options before entering the controlled area (inter-station section). The dispatcher or dispatcher determines the method of radio

¹² **Radio block** is a technical device enabling the control of train traffic in the defined area, in the form of authenticated driving permissions, transmitted to traction and control vehicles via radio network with data transmission and subsequent control of the movement of these vehicles according to the issued permissions.

communication in the alternative radio connection (if it is established on the track). The dispatcher or dispatcher shall notify the persons involved in the management and organization of rail transport to which the issue relates to the specified method of radio communication. In the case of an alternate radio connection, dispatchers, dispatchers and drivers shall also use the call signs assigned to the alternate radio connection used.

3.6 If the traction vehicle (SHV) does not meet conditions for substitute radio communication, it must not be transported into the controlled area (intermediate station section) equipped with the infrastructure part of train radio infrastructure. In the event of a sudden loss of functionality of the basic or substitute radio communication when these are used on the train (PMD), the engine driver must immediately inform the relevant traffic control officer who controls the section where the train (PMD) is located and initiate negotiation of the conditions for further movement of the train according to Article 1.4. POD or this article. ¹³⁾

3.7 At the time of inclusion in the "train or PMD" traffic mode, special traction vehicles (SHV) use the basic radio connection according to the traversed line for connection with the dispatcher or dispatcher. If the SHV design does not allow the installation of a vehicle part of the relevant radio system used on the line or is faulty, an alternative radio connection on the track may be used, with the prior consent of the relevant dispatcher or dispatcher (see Article 3.5). In such a case, the provisions of the SŽ D1 ČÁST PRVNÍ regulation and the Operating Rules of the relevant line radio network also apply to the SHV operation in the "PMD" mode.

3.8. Provisions of article 3.1.and 3.3 do not apply for the purpose of radio communication of historical traction vehicles and historic special traction vehicles which will be used for the movement of exceptional historic or nostalgic trains for the purpose of celebrations, anniversaries or promotions of rail transport and the associated movement of the train to/from such events, to/from repair shops or to/from depot. Such a vehicle, however, or train set must always be equipped with at least an emergency radio connection or an emergency communication for communication between the dispatcher and the engine driver or with members of the train crew. The mode of communication or the calling numbers shall be indicated by the RU in the application for railway capacity allocation or in the system application of the railway operator for these movements and access to these applications must be provided to operation control and railway transport organisation employees.

3.9 Deviating from Article 3.1, the implementation of the "STOP function in the GSM-R system" according to Article 2.1.8 on driving vehicles, i.e. the connection of the vehicle radio station via the locomotive adapter with the main valve of the continuous brake system, is not a condition for access to the transport route operated by the Správa železnic, its use is governed by the locally relevant Operating Regulations for train radio equipment. Its use is governed by the GSM-R Train Radio Equipment Operating Regulations.

4 Consent for product use on railway infrastructure operated by Správa železniční dopravní cesty, státní organizace

4.1 The use of operating terminals of train radio devices must be approved by Správa železnic in a form of a consent for product use on railway infrastructure operated by Správa železniční dopravní cesty, státní organizace.

4.2 The authorisation procedure is governed by the Správa železnic Directive No. 34 for initiating operation of products that are part of communication and signalling systems and electrical

¹³ The engine driver's duties are stipulated by: EU Directive – TSI 995, Annex B, Article 8 and Act No. 266/1995 Coll., as amended, Article 49b(4).

and power systems on railway infrastructure owned by the state as published on the Infrastructure Operation Portal.

4.3 The requirement for issuing the consent for product use as stated in paragraph 1 of this article shall not apply to GSM-R mobile terminals if they are properly put into operation in accordance with applicable statutory provisions.

5 Final Provisions

5.1 On lines not equipped with any infrastructure part of the train radio device at the date of issue of this Network Statement, the specific date for commencement of routine operation (after the equipment of the line is finished) will be published on the Infrastructure Operation Portal six months in advance.

5.2 For lines where the infrastructural part of the train radio equipment will be changed, the specific date of the end of operation of the original train radio equipment will be announced on the Railway Operation Portal no later than three months in advance.

5.3 On lines where existing radio device is replaced by the new GSM-R digital system, both radio systems shall be operated simultaneously (where possible) for a maximum of **two months** from the date of initiation of GSM-R system operation. In such a case, the obligation set out by Art. 3.1 applies accordingly, i.e. traction vehicles must be equipped for a transition period with a vehicle terminal fully compatible at least with one of the systems in use.

5.4 On border lines, where the GSM-R system is built on the Správa železnic side and such a system is not established on the other side, SHV traction vehicles and control vehicles registered abroad may only be equipped for communication on the Správa železnic network contrary to paragraph 3.1 by a portable GSM-R terminal not meeting the conditions set out in Art. 3.3. Such a portable terminal is, in accordance with Decree No. No. 173/1995 Coll., §71, paragraph 4, always considered only as an emergency radio connection. This derogation applies only to movements between the state border and the first station in the Správa železnic network. Operational and organisational matters are regulated by "the International Border Arrangements" and also by GSM-Operational regulations, the relevant Rules of Operation for the SRD-TRS Tesla radio network and regulation of the the respective operating control points.

Annex "G"

ETCS

1 Introductory provisions

ERTMS / ETCS is a European train protection system. It is a class A device according to the CCS TSI. A detailed description of ERTMS / ETCS, its functions and equipment requirements are given in the documents referred to in the CCS TSI.

The following is and will be implemented in the Czech Republic:

- ERTMS / ETCS Level 2 using Full Control mode (ETCS L2 FS),
- ERTMS / ETCS Level 1 using Full Control mode (ETCS L1 FS),
- ERTMS / ETCS Level 1 using the Limited Surveillance Mode (ETCS L1 LS),
- ERTMS / ETCS Level 1/0 in a version that provides an emergency stop of the train in the event of a stop signal (ETCS L1 LS STOP).

The conditions for the operation of locomotives, rolling stock and special traction units with the ETCS mobile system switched on and supervised by this system are specified in the railway undertaking's internal regulations.

The list of line sections equipped with the ERTMS / ETCS track-side section, indicating its basic technical and operational parameters, is given in the table in Chapter 6 of this Annex.

The level used for the ETCS track-side section, its version and the contact details for establishing the connection with each RBC are given in TTP Table 4.

List of lines to be equipped with the ERTMS / ETCS track-side, indicating the level, expected date of its commissioning and the date of introduction of exclusive operation of trains under the supervision of this system based on the Czech Railway Modern Security Plan - Implementation of the European ETCS train protection system approved by Government Resolution CR No. 996/21 of 13 September 2021, is listed in the table in Chapter 6 of this Annex.

2 Encryption keys for ETCS L2

The operation of ERTMS / ETCS Level 2 requires the use of encryption keys, which are used to encrypt useful data for radio transmission between the Radio Block Center (RBC) and the ETCS mobile part. Encryption keys for ETCS mobile parts are issued upon request by the Správa železnic for the RBC under its management. The details of the application and the detailed procedure are set out in a separate document of the Správa železnic published on the Railway Operation Portal.

The condition for activating the encryption keys on the RBC side for the ETCS mobile parts of individual vehicles is to demonstrate the compatibility of the used ETCS mobile part type (including SW version) with the ETCS track-side part (type and SW version) by successfully performing ESC tests in accordance with CCS TSI.

Compatibility is demonstrated by:

- a copy of the EC declaration of verification of the control-command and signaling on-board subsystem for a specific vehicle;
- a copy of the EC certificate of verification of the control-command and signaling on-board subsystem;
- a copy of the report from the successful completion of compatibility tests of the type of mobile part used (according to Chapter 6.5, Annex to Commission Regulation (EU) 2016/919). The scope and conditions for compatibility tests are specified in a separate document of the Správa železnic published on the Railway Operation Portal.

3 Conditions of access to the runway

On selected sections of ETCS-equipped lines, from the date indicated in the table in Chapter 6 of this Annex, the Správa železnic will limit the use of allocated track capacity to the use of a traction, control or special vehicle equipped with a functionally compatible ETCS mobile part.

A vehicle with a functional ETCS mobile part means vehicles for which the appropriate level ETCS compatibility tests are performed and for level 2 encryption keys have also been issued and activated to be able to log in to the RBC of such lines. The conditions for issuing and activating encryption keys for RBC login are given in Chapter 2 of this appendix.

From 1 January 2023, the restriction of the utilization of the allocated capacity due to ETCS concerns the Olomouc (outside) - Uničov line section.

From 1 January 2025, the limitation of the use of the allocated capacity due to ETCS concerns the 1st TŽK line sections: Děčín – Praha – Česká Třebová – Břeclav, the 2nd TŽK line sections: Břeclav – Přerov – Bohumín and the connecting line Přerov – Česká Třebová.

From the date of the announcement (termination of the function of the temporary security device) in ŽST Praha Masarykovo nádraží including the Prague–Bubny district (as part of the Modernization and completion of ŽST Praha Masarykovo nádraží construction) the restriction of the use of the allocated capacity also applies to the track sections adjacent to ŽST Praha Masarykovo nádraží. Restrictions on the use of allocated track capacity only to the use of a vehicle that is equipped with a functionally compatible ETCS mobile part also apply at connection / branch stations. In specific cases, it will be possible to allocate capacity to this connection / branch station by the end of 2029, but no later than until the start of exclusive operation on the connection / branch line. A list of such connection / branch stations for the sections on which ETCS exclusive operation will start between 2023 and 2025 is given in Chapter 7 of this Annex.

For border sections from st. hr. Germany / CZ - Dolní Žleb - Děčín-Prostřední Žleb - Děčín hl. n. (up to the level of departure signals to Povrly), from st. hr. SK / CZ - Lanžhot - Břeclav (up to the level of departure signals to Podivín, or to Hrušek) and from st. hr. PL / CZ - Petrovice u Karviné - Závada - Dětmárovice - Bohumín / Koukolná - Karviná hl. n. (out) they remain in mixed traffic and thus it will be possible to allocate capacity on this section even without a functional compatible ETCS mobile part until exclusive traffic is introduced on the border section of the neighboring state.

For trains not reaching the minimum braking percentage of 30%, the use of the allocated track capacity for driving with the active mobile part of the ETCS system is limited. In sections with ETCS L1 LS, the minimum amount of braking percentages for train travel with the active mobile part of the ETCS system is set at 50%. In sections with exclusive ETCS operation, there is a restriction on the use of the allocated track capacity only for trains with the required braking percentages.

4 ETCS development

The migration period for the ETCS system in the Czech Republic for lines with mixed operation of ETCS equipped vehicles and non-ETCS vehicles is determined as the time from the start of routine ETCS operation on a given continuously equipped line section until the introduction of all trains exclusively under ETCS supervision.

The duration of the migration period for ETCS must be minimized with regard to safety and other negative operational effects. The migration period for a given line (line section) will last a maximum of five years according to the valid ERTMS National Implementation Plan. The dates of the end of the migration period for specific routes are listed in the table in Chapter 6 of this Annex.

At the end of the migration period, the trackside part of the national train protection system LS will be decommissioned and the advantages of ETCS in terms of increasing the level of safety and efficiency of rail traffic management will be fully implemented.

As part of the construction of new lines or upgraded lines, sections equipped exclusively with ETCS will be put into operation, for which only ETCS-equipped vehicles will be possible from the time of commissioning. The ETCS system version in these sections will be 2.1 or higher depending on the current version of the CCS TSI.

5 Final provisions

The specific sections equipped with ETCS and the date of commissioning of ETCS will be published at least 3 months in advance before the start of routine operation on the Railway Operation Portal, including the conditions for using the system.

6 List of line sections with ETCS

The meaning of the individual columns and the signs used:

- Column number: 1 – track number
 2 name of the beginning of the track
 3 name of the end of the track
 4 – ETCS implemented
 5 – the year of the introduction of exclusive train operation under ETCS
 6 – ETCS level
 7 – system version

1	2	3	4	5	6	7
100 00	Plzeň hlavní nádraží	Cheb	ano	2027	L2 FS	1.1
101 00	Aš	Hranice v Čechách		2040	STOP	1.1
102 00	Františkovy Lázně	Aš státní hranice		2029	L2 FS	2.1
103 00	Cheb	Vojtanov státní hranice		2030	L2 FS	2.1
104 00	Cheb	Cheb státní hranice	ano	2032	L2 FS	1.1
105 00	Mariánské Lázně	Karlovy Vary		2029	STOP	1.1
106 00	Domažlice odbočná výh.č.401	Tachov		2029	STOP	1.1
106 00	Tachov	Planá u Mariánských Lázní		2027	STOP	1.1
107 00	Svojšín	Bor		2038	STOP	1.1
108 00	Pňovany	Bezručovice		2027	STOP	1.1
120 00	Chomutov	Cheb		2028	L2 FS	2.1
121 00	Tršnice	Františkovy Lázně		2028	L2 FS	2.1
122 00	Tršnice	Luby u Chebu		2028	STOP	1.1
123 00	Sokolov os.n.	Kraslice st.hr.		2038	STOP	1.1
124 00	Krásný Jez	Horní Slavkov		2038	STOP	1.1
124 00	Nové Sedlo u Lokte	Loket		2038	STOP	1.1
125 00	Chodov	Nová Role		2029	STOP	1.1
126 00	Karlovy Vary-Sedlec	Potůčky státní hranice		2029	STOP	1.1
127 00	Dalovice	Merklín		2038	STOP	1.1
128 00	Kadaň-Předměstí	Kadaň-Prunéřov		2034	L2 FS	2.1
129 00	Kaštice	Kadaň-Předměstí		2038	STOP	1.1
131 00	Kadaňský Rohozec	Vilémov u Kadaně		2038	STOP	1.1
132 00	Chomutov	Vejprty státní hranice		2038	STOP	1.1
133 00	Droužkovice	Dubina odbočka		2031	L2 FS	2.1
140 00	Most	Chomutov		2030	L2 FS	2.1
141 00	Chomutov město	Chomutov seř.n.		2030	L2 FS	2.1
142 00	Březno u Chomutova	Chomutov		2031	L2 FS	2.1

1	2	3	4	5	6	7
143 00	Dolní Rybník odbočka	Jirkov		2034	L2 FS	2.1
144 00	Třebošice	Most nové nádraží		2030	L2 FS	2.1
145 00	Most	Most nové nádraží		2030	L2 FS	2.1
146 00	Most nové nádraží	Louka u Litvínova		2034	L1 LS	2.1
147 00	Louka u Litvínova	Litvínov		2034	L1 LS	2.1
148 00	Louka u Litvínova	Osek město		2028	STOP	1.1
148 00	Osek město	Moldava v Krušných horách		2034	STOP	1.1
149 00	Louny	Most		2034	L1 LS	2.1
160 00	Ústí nad Labem hlavní nádraží	Most		2030	L2 FS	2.1
161 00	České Zlatníky odbočka	Obrnice		2031	L2 FS	2.1
162 00	Oldřichov u Duchcova	Louka u Litvínova		2034	L1 LS	2.1
164 00	Děčín hl.n.	Oldřichov u Duchcova				
165 00	Ústí nad Labem západ	Bílina		2030	L2 FS	2.1
166 00	Řetenice	Úpořiny		2038	STOP	1.1
166 00	Úpořiny	Lovosice		2038	STOP	1.1
168 00	Ústí nad Labem západ St. 5	Ústí nad Labem západ vhb. 852		2030	L2 FS	2.1
169 00	Ústí nad Labem hlavní nádraží jih	Ústí nad Labem západ		2030	L2 FS	2.1
180 00	Plzeň hlavní nádraží	Žatec západ		2028	L1 LS	2.1
180 00	Žatec západ	Žatec		2028	L2 FS	2.1
181 00	Rakovník	Blatno u Jesenice		2029	STOP	1.1
181 00	Blatno u Jesenice	Bečov nad Teplou		2038	STOP	1.1
182 00	Protivec	Bochov		2038	STOP	1.1
183 00	Rakovník	Kralovice u R.		2038	STOP	1.1
183 00	Kralovice u R.	Mladotice				
184 00	Žatec západ	Žatec-Velichov		2031	L2 FS	2.1
185 00	Žatec	Březno u Chomutova		2031	L2 FS	2.1
186 00	Lužná u Rakovníka	Žatec		2038	STOP	1.1
187 00	Žatec	Obrnice		2031	L2 FS	2.1
188 00	Louny	Postoloprty		2038	L1 LS	2.1
189 00	Odb. Bažantnice	Odb. Vrbka		2038	L1 LS	2.1
191 00	Louny předměstí	Rakovník		2029	L1 LS	2.1
192 00	Krupá	Kolešovice		2038	STOP	1.1
200 00	Plzeň hlavní nádraží	Česká Kubice státní hranice		2029	L2 FS	2.1
201 00	Staňkov - Vránov	Poběžovice		2029	STOP	1.1
202 00	Janovice nad Úhlavou	Domažlice		2034	L1 LS	2.1
203 00	Nýřany	Heřmanova Huť		2026	L2 FS	2.1
204 00	Klatovy	Železná Ruda-Alžbětín		2034	L1 LS	2.1
205 00	Plzeň hlavní nádraží	Klatovy		2028	L2 FS	2.1
220 00	Nemanice	Plzeň hlavní nádraží		2030	L2 FS	2.1
221 00	Nepomuk	Blatná	ano	2029	STOP	1.1
222 00	Horaždovice předměstí	Klatovy		2034	L1 LS	2.1
223 00	Strakonice	Volary		2034	STOP	1.1
224 00	Březnice	Strakonice	ano	2029	STOP	1.1

1	2	3	4	5	6	7
225 00	Putim	Ražice		2030	L2 FS	2.1
226 00	Čičenice	Volary		2034	STOP	1.1
227 00	Čičenice	Temelín		2029	STOP	1.1
227 00	Temelín	Týn nad Vltavou	ano	2029	STOP	1.1
228 00	Dívčice	Netolice		2038	STOP	1.1
240 00	Horní Dvořiště státní hranice	České Budějovice		2029	L2 FS	1.1
241 00	Volary	České Budějovice, odbočná výh.č.502		2029	STOP	1.1
242 00	Černý Kříž	Nové Údolí		2034	STOP	1.1
243 00	Rybník	Lipno nad Vltavou		2029	STOP	1.1
260 00	České Velenice státní hranice	České Budějovice		2027	L2 FS	1.1
261 00	České Velenice	Veselí nad Lužnicí		2027	L2 FS	2.1
280 00	České Budějovice	Votice	ano	2026	L2 FS	1.1
280 00	Votice	Benešov u Prahy	ano	2026	L2 FS	1.1
281 00	Tábor	Bechyně		2034	STOP	1.1
282 00	Tábor	Písek město		2029	L1 LS	2.1
282 00	Písek město	Písek		2030	L2 FS	2.1
283 00	Horní Cerekev	Tábor		2034	L1 LS	2.1
284 00	Olbramovice	Sedlčany		2034	STOP	1.1
285 00	Trhový Štěpánov	Benešov u Prahy		2034	L1 LS	2.1
300 00	Benešov u Prahy	Praha-Uhřetěves	ano	2026	L2 FS	1.1
301 00	Praha-Uhřetěves	Praha-Zahradní Město		2026	L2 FS	1.1
302 00	Praha-Zahradní Město	Praha-Vršovice		2027	L2 FS	1.1
303 00	Čerčany	Vrané nad Vltavou		2029	L1 LS	2.1
303 00	Vrané nad Vltavou	Praha-Krč		2030	L1 LS	2.1
304 00	Dobříš	Skochovice odbočka		2034	L1 LS	2.1
305 00	Světlá nad Sázavou	Čerčany		2034	L1 LS	2.1
320 00	Praha-Libeň	Praha hlavní nádraží		2029	L2 FS	2.1
321 00	Praha-Libeň	Praha-Holešovice Stromovka	ano	2025	L2 FS	1.1
322 00	Praha Masarykovo nádraží-Hrabovka	Praha Masarykovo n.- Viadukt		2027	L2 FS	2.1
323 00	Balabenka odbočka	Praha Masarykovo nádraží- Sluncová		2027	L2 FS	2.1
324 00	Praha-Libeň	Praha Masarykovo nádraží		2027	L2 FS	2.1
325 00	Balabenka odbočka	Praha-Holešovice Rokytky		2030	L2 FS	1.1
326 00	Praha-Vršovice	Praha hlavní nádraží		2030	L2 FS	2.1
327 00	Praha hlavní nádraží	Balabenka odbočka		2030	L2 FS	2.1
328 00	Praha-Libeň	Praha-Vysočany		2029	L2 FS	1.1
329 00	Praha-Malešice	Praha-Zahradní Město		2027	L2 FS	1.1
332 00	Praha-Běchovice	Praha-Malešice	ano	2025	L2 FS	1.1
333 00	Praha-Libeň	Praha-Malešice	ano	2025	L2 FS	1.1
334 00	Praha-Hostivař	Praha-Malešice	ano	2026	L2 FS	1.1
335 00	Praha-Vršovice	Praha-Vyšehrad výhybna		2030	L2 FS	1.1
336 00	Praha-Vršovice	DKV Praha PP Praha jih		2030	L2 FS	1.1
337 00	Praha-Krč	Praha-Vršovice		2030	L2 FS	1.1
339 00	Praha-Malešice	Praha-Žižkov				
340 00	Praha-Radotín	Beroun		2028	L2 FS	1.1
341 00	Rakovník	Beroun Závodí		2029	L1 LS	2.1

1	2	3	4	5	6	7
341 00	Beroun Závodí	Beroun	ano	2030	L2 FS	1.1
342 00	Praha-Smíchov	Beroun-Závodí		2030	L2 FS	1.1
343 00	Praha-Smíchov severní zhlaví	Hostivice		2028	L2 FS	1.1
344 00	Rudná u Prahy	Jeneček odbočka		2030	L2 FS	1.1
345 00	Jeneček odbočka	Podlešín		2031	L1 LS	2.1
346 00	Jeneček vhb.č.5	Jeneček vhb.č.6		2030	L2 FS	1.1
347 00	Praha-Smíchov	Praha-Radotín		2030	L2 FS	1.1
348 00	Praha-Zahradní Město	Odbočka Závodiště		2030	L2 FS	1.1
349 00	Praha hlavní nádraží	Praha-Smíchov		2030	L2 FS	2.1
360 00	Beroun	Plzeň hlavní nádraží	ano	2027	L2 FS	1.1
361 00	Ejpovice	Radnice		2027	STOP	1.1
362 00	Rokycany	Nezvěstice		2032	L1 LS	2.1
363 00	Zdice	Písek		2029	L1 LS	2.1
363 00	Písek	Protivín		2030	L2 FS	2.1
364 00	Rožmitál p. Třemšínem	Březnice		2038	STOP	1.1
365 00	Zadní Třebaň	Liteň		2029	STOP	1.1
365 00	Liteň	Lochovice		2037	STOP	1.1
380 00	Praha-Holešovice Stromovka	Kralupy nad Vltavou	ano	2025	L2 FS	1.1
381 00	Praha-Bubny	Praha-Holešovice Stromovka	ano	2025	L2 FS	1.1
382 00	Praha Masarykovo nádraží	Praha-Bubny		2027	L2 FS	2.1
383 00	Praha-Bubny	Kladno		2029	L2 FS	2.1
384 00	Kladno	Lužná u Rakovníka		2029	L1 LS	2.1
385 00	Lužná u Rakovníka	Rakovník		2029	L1 LS	2.1
386 00	Kladno	Kralupy nad Vltavou		2029	L2 FS	2.1
400 00	Kralupy nad Vltavou	Losovice		2025	L2 FS	2.1
401 00	Kralupy nad Vltavou	Louny		2034	STOP	1.1
402 00	Kralupy nad Vltavou předměstí	Velvary		2031	STOP	1.1
403 00	Vraňany	Lužec nad Vltavou		2038	L2 FS	2.1
404 00	Roudnice nad Labem	Straškov		2038	STOP	1.1
405 00	Vraňany	Libochovice		2038	STOP	1.1
406 00	Straškov	Zlonice		2038	STOP	1.1
407 00	Losovice	Čížkovice		2034	L2 FS	2.1
407 00	Čížkovice	Louny		2037	STOP	1.1
420 00	Losovice	Děčín hlavní nádraží		2025	L2 FS	2.1
421 00	Děčín hlavní nádraží	Děčín státní hranice		2031	L2 FS	2.1
422 00	Děčín východ dolní nádraží	Děčín-Prostřední Žleb		2031	L2 FS	2.1
423 00	Děčín hlavní nádraží	Děčín východ dolní nádraží		2031	L2 FS	2.1
440 00	Nymburk hlavní nádraží	Ústí nad Labem-Střekov		2027	L2 FS	2.1
441 00	Ústí nad Labem- Střekov	Děčín východ		2026	L2 FS	2.1
442 00	Ústí nad Labem- Střekov	Ústí nad Labem západ		2030	L2 FS	2.1

1	2	3	4	5	6	7
443 00	Žalhostice	Velké Žernoseky		2034	L2 FS	2.1
444 00	Mělník	Mladá Boleslav hlavní nádraží		2038	STOP	1.1
445 00	Lysá nad Labem	Milovice		2027	L2 FS	1.1
446 00	Lysá nad Labem	Praha-Vysočany		2027	L2 FS	1.1
447 00	Čelákovice	Mochov		2038	STOP	1.1
460 00	Česká Lípa hlavní nádraží	Liberec		2033	L1 LS	2.1
461 00	Lovosice	Litoměřice hor.n.		2034	L2 FS	2.1
461 00	Litoměřice hor.n.	Česká Lípa hlavní nádraží		2034	L1 LS	2.1
462 00	Benešov nad Ploučnicí	Česká Lípa hlavní nádraží		2031	L1 LS	2.1
463 00	Děčín východ	Benešov nad Ploučnicí		2031	L2 FS	2.1
464 00	Benešov nad Ploučnicí	Jedlová		2031	L1 LS	2.1
465 00	Česká Lípa hlavní nádraží	Rumburk		2031	L1 LS	2.1
466 00	Rumburk	Rumburk státní hranice		2031	L1 LS	2.1
467 00	Mikulášovice dolní nádraží	Rumburk		2031	STOP	1.1
468 00	Rumburk	Dolní Poustevna státní hranice		2031	STOP	1.1
469 00	Panský	Krásná Lípa		2031	STOP	1.1
471 00	Rybniště	Varnsdorf státní hranice		2031	L1 LS	2.1
472 00	Varnsdorf	Varnsdorf staré nádraží státní hranice		2031	L1 LS	2.1
473 00	Srní u České Lípy	Žizníkov výhybna		2031	L1 LS	2.1
474 00	Mimoň	Mimoň staré nádraží		2031	L1 LS	2.1
480 00	Skály odbočka	Všetaty		2029	L2 FS	2.1
480 00	Všetaty	Turnov		2032	L2 FS	1.1
481 00	Balabenka odbočka	Praha-Vysočany		2029	L2 FS	1.1
482 00	Kralupy nad Vltavou	Neratovice		2029	L2 FS	2.1
483 00	Čelákovice	Neratovice		2034	L1 LS	2.1
484 00	Nymburk hlavní nádraží	Mladá Boleslav hlavní nádraží		2028	L2 FS	2.1
485 00	Mladá Boleslav hlavní nádraží	Mladá Boleslav město		2030	L2 FS	2.1
486 00	Mladá Boleslav město	Stará Paka		2034	STOP	1.1
487 00	Bakov nad Jizerou	Česká Lípa hlavní nádraží		2031	L1 LS	2.1
488 00	Bakov nad Jizerou-Zálučí odbočka	Dolní Bousov		2034	STOP	1.1
491 00	Hradec Králové hlavní nádraží	Jičín		2034	L1 LS	2.1
491 00	Jičín	Turnov		2034	STOP	1.1
492 00	Jičín	Veleliby		2034	L1 LS	2.1
492 00	Veleliby	Nymburk město		2030	L2 FS	2.1
500 00	Jaroměř	Turnov		2033	L1 LS	1.1
500 00	Turnov	Liberec		2033	L2 FS	2.1
501 00	Liberec	Hrádek nad Nisou státní hranice		2033	L1 LS	2.1
502 00	Liberec	Frýdlant v Čechách státní hranice		2032	L1 LS	2.1
503 00	Frýdlant v Čechách	Jindřichovice pod Smrkem		2033	STOP	1.1
504 00	Bílý Potok pod Smrkem	Raspenava		2032	STOP	1.1

1	2	3	4	5	6	7
505 00	Liberec	Tanvald		2029	L1 LS	2.1
506 00	Smržovka	Josefův Důl		2029	L1 LS	2.1
507 00	Tanvald	Harrachov státní hranice		2029	STOP	1.1
508 00	Železný Brod	Tanvald		2029	L1 LS	2.1
520 00	Kolín	Praha-Libeň	ano	2025	L2 FS	1.1
521 00	Nymburk hlavní nádraží	Poříčany		2030	L2 FS	2.1
522 00	Pečky	Plaňany		2034	STOP	1.1
522 00	Plaňany	Kouřim		2038	STOP	1.1
523 00	Bošice	Bečváry				
524 00	Praha-Běchovice Blatov	Praha-Běchovice	ano	2025	L2 FS	1.1
540 00	Česká Třebová	Kolín	ano	2025	L2 FS	1.1
541 00	Prachovice	Přelouč		2029	L1 LS	2.1
542 00	Heřmanův Městec	Chrudim město				
542 00	Chrudim	Borohrádek		2029	STOP	1.1
543 00	Chrudim	Chrudim město		2029	STOP	1.1
544 00	Choceň	Litomyšl		2025	STOP	1.1
545 00	Letohrad	Ústí nad Orlicí	ano	2029	L2 FS	1.1
546 00	Lichkov státní hranice	Letohrad	ano	2029	L2 FS	1.1
547 00	Letohrad	Častolovice		2032	L1 LS	2.1
547 00	Častolovice	Týniště nad Orlicí		2028	L2 FS	1.1
548 00	Častolovice	Solnice		2028	L2 FS	1.1
549 00	Doudleby nad Orlicí	Vamberk		2038	STOP	1.1
549 00	Vamberk	Rokytnice v Orlických horách		2038	STOP	1.1
551 00	Hanušovice	Lichkov		2038	STOP	1.1
552 00	Štítý	Dolní Lipka		2034	STOP	1.1
553 00	Hanušovice-Morava	Staré Město pod Sněžníkem		2034	STOP	1.1
560 00	Kolín	Nymburk hlavní nádraží		2030	L2 FS	2.1
561 00	Babín odbočka	Nymburk hlavní nádraží		2030	L2 FS	2.1
562 00	Choceň	Velký Osek		2028	L2 FS	2.1
563 00	Chlumeck nad Cidlinou	Obora odbočka		2028	STOP	1.1
564 00	Kolín-Hradištko	Prům.zóna TPCA	ano	2030	L2 FS	1.1
580 00	Pardubice hlavní nádraží	Hradec Králové hlavní nádraží		2028	L2 FS	1.1
581 00	Opatovice nad Labem-Pohřebačka	Plačice odbočka		2028	L2 FS	1.1
582 00	Havlíčkův Brod	Pardubice-Rosice nad Labem		2033	L1 LS	2.1
600 00	Hradec Králové hlavní nádraží	Jaroměř		2028	L2 FS	1.1
601 00	Hněvčoves	Smiřice		2038	STOP	1.1
620 00	Jaroměř	Trutnov hlavní nádraží		2031	L1 LS	2.1
621 00	Trutnov hlavní nádraží	Chlumeck nad Cidlinou		2031	L1 LS	2.1
622 00	Martinice v Krkonoších	Rokytnice nad Jizerou		2031	STOP	1.1
623 00	Kunčice nad Labem	Vrchlabí		2031	L1 LS	2.1
624 00	Trutnov hl.n.	Svoboda nad Úpou		2038	STOP	1.1
625 00	Trutnov-Poříčí	Královec státní hranice		2038	STOP	1.1
626 00	Královec	Žacléř		2038	STOP	1.1

1	2	3	4	5	6	7
627 00	Teplice nad Metují	Trutnov střed		2031	STOP	1.1
628 00	Týniště nad Orlicí	Meziměstí státní hranice		2032	L1 LS	2.1
629 00	Meziměstí	Otovice zastávka		2038	STOP	1.1
631 00	Václavice	Starkoč		2032	L1 LS	2.1
632 00	Dobruška	Opočno pod Orlickými horami		2038	STOP	1.1
640 00	Veselí nad Lužnicí	Jihlava		2032	L2 FS	2.1
641 00	Slavonice	Kostelec u Jihlavy		2034	L1 LS	2.1
642 00	Střelice	Zastávka u Brna		2028	L2 FS	1.1
642 00	Zastávka u Brna	Studenec		2031	L2 FS	1.1
642 00	Studenec	Jihlava		2031	L1 LS	2.1
643 00	Brno-Horní Heršpice	Střelice		2028	L2 FS	1.1
644 00	Znojmo státní hranice	Okříšky		2032	STOP	1.1
645 00	Moravské Budějovice	Jemnice		2038	STOP	1.1
660 00	Jihlava	Havlíčkův Brod		2030	L2 FS	1.1
661 00	Dobronín	Polná		2038	STOP	1.1
680 00	Havlíčkův Brod	Kolín		2030	L2 FS	1.1
681 00	Kolín	Ledečko st.1		2034	STOP	1.1
682 00	Kutná Hora hlavní nádraží	Kutná Hora město		2034	L1 LS	2.1
682 00	Kutná Hora město	Zruč nad Sázavou		2034	STOP	1.1
683 00	Čáslav	Třemošnice		2034	STOP	1.1
684 00	Havlíčkův Brod	Humpolec		2029	STOP	1.1
700 00	Brno-Židenice	Havlíčkův Brod		2030	L2 FS	1.1
701 00	Tišnov	Žďár nad Sázavou		2034	L1 FS	2.1
702 00	Studenec	Křižanov		2030	STOP	1.1
702 90	Oslavice	Velké Meziříčí staré nádraží				
720 00	Lanžhot státní hranice	Modřice	ano	2025	L2 FS	1.1
721 00	Modřice	Brno hlavní nádraží		2030	L2 FS	1.1
722 00	Brno H.-Heršpice-Modřické z.	Brno-Maloměřice st.6		2030	L2 FS	1.1
723 00	Modřice	Brno-Horní Heršpice Modřické zhl.		2030	L2 FS	1.1
724 00	Brno-Horní Heršpice Státní silnice	Brno-Horní Heršpice km 11,690		2028	L2 FS	1.1
725 00	Brno-Černovice odbočka	Brno-Černovice zhl.Táborská odbočka		2030	L2 FS	1.1
726 00	Hrušovany u Brna	Židlochovice	ano	2025	L2 FS	1.1
728 00	Hustopeče u Brna	Šakvice	ano	2025	L2 FS	1.1
729 00	Hodonín	Zaječí		2031	STOP	1.1
732 00	Břeclav státní hranice	Břeclav	ano	2029	L2 FS	1.1
733 00	Břeclav	Znojmo		2029	L2 FS	1.1
734 00	Boří les	Lednice		2038	STOP	1.1
736 00	Střelice	Hrušovany nad Jevišovkou		2038	L1 LS	2.1
737 00	Moravské Bránice	Oslavany		2038	L1 LS	2.1
740 00	Brno-Maloměřice st.6	Česká Třebová	ano	2025	L2 FS	1.1
741 00	Česká Třebová odjezdová skupina	Parník odbočka	ano	2025	L2 FS	1.1
742 00	Třebovice v Čechách	Česká Třebová odjezdová skupina		2030	L2 FS	2.1

1	2	3	4	5	6	7
743 00	Česká Třebová vjezdová skupina	Parník odbočka		2030	L2 FS	2.1
744 00	Zádulka odbočka	Les odbočka		2030	L2 FS	2.1
745 00	Zádulka odbočka	Česká Třebová vjezdová skupina		2030	L2 FS	2.1
746 00	Třebovice v Čechách	Česká Třebová odjezdová skupina		2030	L2 FS	2.1
747 00	Svitavy	Žďárec u Skutče		2030	STOP	1.1
748 00	Chornice	Boskovice		2038	STOP	2.1
748 00	Boskovice	Skalice nad Svitavou		2030	L2 FS	1.1
749 00	Brno hlavní nádraží	Brno-Maloměřice st.6		2030	L2 FS	1.1
751 00	Holubice	Brno hlavní nádraží		2031	L2 FS	2.1
752 00	Přerov	Holubice		2030	L2 FS	2.1
753 00	Holubice	Blažovice		2030	L2 FS	2.1
754 00	Kojetín	Tovačov		2038	STOP	1.1
760 00	Prosenice	Česká Třebová	ano	2025	L2 FS	1.1
761 00	Chornice	Třebovice v Čechách		2025	STOP	1.1
762 00	Kostelec na Hané	Chornice		2034	STOP	1.1
763 00	Prostějov hlavní nádraží	Kostelec na Hané		2034	L1 LS	2.1
764 00	Olomouc hlavní nádraží	Nezamyslice		2027	L2 FS	1.1
765 00	Senice na Hané	Červenka		2029	L1 LS	2.1
766 00	Kostelec na Hané	Senice na Hané		2034	L1 LS	2.1
767 00	Litovel předměstí	Mladeč		2034	STOP	1.1
768 00	Senice na Hané	Olomouc hlavní nádraží		2029	L1 LS	2.1
769 00	Lanškroun	Rudoltice v Čechách		2025	STOP	1.1
771 00	Zábřeh na Moravě	Šumperk		2029	L2 FS	1.1
772 00	Bludov-Sudkov	Bludov-Chromeč		2032	L2 FS	1.1
773 00	Hanušovice	Bludov		2032	L1 LS	2.1
774 00	Mikulovice státní hranice	Hanušovice		2032	L1 LS	2.1
775 00	Lipová Lázně	Javorník ve Slezsku		2038	STOP	1.1
776 00	Velká Kraš	Vidnava				
777 00	Zlaté Hory	Mikulovice		2038	STOP	1.1
778 00	Šumperk	Uničov		2025	L2 FS	1.1
778 00	Uničov	Olomouc hlavní nádraží	ano	ano	L2 FS	1.1
780 00	Bohumín	Prosenice	ano	2025	L2 FS	1.1
781 00	Suchdol nad Odrou	Budišov nad Budišovkou		2034	STOP	1.1
782 00	Suchdol nad Odrou	Fulnek		2029	STOP	1.1
783 00	Suchdol nad Odrou	Nový Jičín město		2029	STOP	1.1
784 00	Studénka	Bílovec	ano	2029	STOP	1.1
785 00	Studénka	Sedlnice		2034	L2 FS	1.1
786 00	Sedlnice	Mošnov,Ostrava Airport		2034	L2 FS	1.1
787 00	Sedlnice	Veřovice		2034	L2 FS	1.1
791 00	Odra odbočka	Ostrava-Svinov	ano	2028	L2 FS	1.1
792 00	Ostrava hlavní nádraží	Vratimov		2028	L2 FS	1.1
793 00	Bohumín-Vrbice státní hranice	Bohumín-Vrbice	ano		L2 FS	1.1
794 00	Bohumín státní hranice	Bohumín	ano		L2 FS	1.1
795 00	Ostrava-Svinov	Opava východ		2034	L2 FS	2.1
796 00	Hlučín	Opava východ		2034	STOP	1.1

1	2	3	4	5	6	7
797 00	Chuchelná	Kravaře ve Slezsku		2034	STOP	1.1
800 00	Přerov	Břeclav	ano	2025	L2 FS	1.1
801 00	Hodonín	Hodonín státní hranice		2029	L1 LS	2.1
802 00	Rohatec	Veselí nad Moravou		2029	L1 LS	2.1
803 00	Velká nad Veličkou státní hranice	Veselí nad Moravou		2029	L1 LS	2.1
804 00	Sudoměřice nad Moravou	Sudoměřice nad Moravou státní hranice			L1 LS	2.1
805 00	Veselí nad Moravou	Blažovice		2027	L2 FS	2.1
806 00	Blažovice	Brno-Černovice odbočka		2030	L2 FS	2.1
807 00	Brno-Černovice odbočka	Brno hlavní nádraží		2030	L2 FS	1.1
808 00	Moravský Písek	Bzenec		2027	L2 FS	2.1
811 00	Kunovice	Veselí nad Moravou		2028	L2 FS	1.1
812 00	Vlářský průsmyk státní hranice	Uherský Brod		2034	L1 LS	2.1
812 00	Uherský Brod	Staré Město u Uherského Hradiště		2028	L2 FS	1.1
813 00	Luhačovice	Újezdec u Luhačovic		2030	L1 LS	2.1
814 00	Zlín střed	Otrokovice		2027	L2 FS	2.1
815 00	Vizovice	Zlín střed		2027	L2 FS	2.1
816 00	Přerov	Dluhonice výhybna	ano	2025	L2 FS	1.1
817 00	Prosenice	Přerov	ano	2025	L2 FS	1.1
820 00	Horní Lideč státní hranice	Hranice na Moravě		2026	L2 FS	1.1
821 00	Valašské Meziříčí	Hulín		2034	L1 LS	2.1
821 00	Hulín	Kojetín		2030	L2 FS	2.1
822 00	Zborovice	Kroměříž		2034	STOP	1.1
823 00	Vratimov	Veřovice		2030	L2 FS	2.1
823 00	Veřovice	Valašské Meziříčí		2034	L1 LS	2.1
824 00	Rožnov pod Radhoštěm	Valašské Meziříčí		2034	STOP	1.1
825 00	Frýdlant nad Ostravicí	Ostravice	ano	2030	STOP	1.1
826 00	Vsetín-Bečva	Velké Karlovice		2027	STOP	1.1
827 00	Bylnice	Horní Lideč		2034	STOP	1.1
840 00	Opava východ	Krnov		2034	L2 FS	2.1
840 00	Krnov	Olomouc hlavní nádraží		2034	L1 LS	2.1
841 00	Valšov	Rýmařov		2034	STOP	1.1
842 00	Bruntál	Malá Morávka		2038	STOP	1.1
843 00	Milotice nad Opavou	Vrbno pod Pradědem		2038	STOP	1.1
844 00	Krnov	Jindřichov ve Slezsku státní hranice		2038	L1 LS	2.1
845 00	Osoblaha	Třemešná ve Slezsku		2038	STOP	1.1
846 00	Opava východ	Hradec nad Moravicí		2034	STOP	1.1
847 00	Moravice odbočka	Svobodné Heřmanice		2038	STOP	1.1
860 00	Dětmarovice	Bohumín	ano	2028	L2 FS	1.1
861 00	Petrovice u Karviné státní hranice	Dětmarovice	ano		L2 FS	1.1
862 00	Karviná město	Petrovice u Karviné				
880 00	Chotěbuz	Dětmarovice	ano	2028	L2 FS	1.1
881 00	Koukolná odbočka	Závada odbočka	ano	2028	L2 FS	1.1
882 00	Český Těšín	Ostrava-Kunčice		2028	L2 FS	2.1

1	2	3	4	5	6	7
883 00	Ostrava-Kunčice	Polanka nad Odrou výhybna		2028	L2 FS	2.1
884 00	Mosty u Jablunkova státní hranice	Chotěbuz	ano	2028	L2 FS	1.1
885 00	Český Těšín	Frýdek-Místek		2034	L1 LS	2.1
886 00	Český Těšín státní hranice	Český Těšín	ano		L2 FS	1.1

7 List of connecting / branch stations with exclusive operation in the years 2023 to 2025

In the specific cases below, it will be possible to allocate capacity to this connection / branch station by the end of 2029, but no later than until the start of exclusive operation on the connection / branch line.

Section Děčín – Praha – Česká Třebová – Břeclav:

- Děčín-Prostřední Žleb od Děčína východu dolního nádraží
- Děčín hl. n. osobní nádraží od Děčína západního nádraží
- Děčín hl. n. kolejová skupina střed od Děčína západního n.
- Děčín hl. n. od Děčína východu horního nádraží
- Ústí nad Labem hl. n. od Ústí nad Labem západu
- Ústí nad Labem hl. n. obvod jih od Ústí nad Labem západu
- Lovosice od Chotiměře
- Lovosice od Čížkovic
- Lovosice od Žalhostic
- Roudnice nad Labem od Straškova
- Hněvice seř. n. od vlečky V3060
- Hněvice os. n. od vlečky V3059 (elektrárna)
- Vraňany od Straškova
- Vraňany od Lužce nad Vltavou
- Kralupy nad Vltavou od Otovic
- Kralupy nad Vltavou od Kralup nad Vltavou předměstí
- Kralupy nad Vltavou od Chvatěrub
- Praha-Libeň od Prahy-Vysočan
- Poříčany od Sadské
- Pečky od Plaňan
- Kolín od Ratboře
- Kolín od Velkého Oseka
- Kolín od vlečky TPCA
- Kolín od Kutné Hory hl. n.
- Přelouč od Choltic
- Pardubice hl. n. od Pardubic-Rosic nad Labem
- Moravany od Hrochova Týnce
- Moravany od Holic
- Choceň od Újezdu u Chocně
- Choceň od Vysokého Mýta
- Ústí nad Orlicí od Lanšperka
- Svitavy od Květné
- Skalice nad Svitavou od Boskovic
- Zaječí od Velkých Pavlovic
- Břeclav osobní nádraží od Bořího lesa

Section Břeclav – Přerov – Bohumín:

- Hodonín od Holíče nad Moravou
- Hodonín od Mutěnic
- Rohatec od Sudoměřic
- Moravský Písek od Bzence
- Staré Město u Uherského Hradiště od Uherského Hradiště

- Otrokovice od Zlína-Malenovic
- Hulín od Třebetic
- Hulín od Kroměříže
- Hranice na Moravě od Hranic na Moravě města
- Suchdol nad Odrou od Fulneku
- Suchdol nad Odrou od Nového Jičína města
- Suchdol nad Odrou od Oder
- Studénka od Bílovce
- Studénka od Sedlnic-Bartošovic
- Ostrava-Svinov od Ostravy-Třebovic
- Ostrava hl.n (do doby rekonstrukce SZZ)
- Bohumín-Vrbice od Chalupek (PKP)
- Bohumín přednádraží od vlečky V6009 (Rychvald)
- Bohumín osobní od Chalupek (PKP)

Section Přerov – Česká Třebová:

- Třebovice v Čechách od Mladějova
- Rudoltice v Čechách od Lanškrouna
- Zábřeh na Moravě od Postřelmovy
- Červenka od Litovle
- Olomouc hl. n. od Olomouce-Nové Ulice
- Olomouc hl. n. od Blatce
- Olomouc hl. n. od obvodu Olomouc-Bělidla

Line Olomouc hl. n. (mimo) – Uničov

- Uničov od Troubelic

8 ETCS implementation plan in the Czech Republic

Plán implementace ETCS v České republice



- výhradní provoz vlaků pod dohledem ETCS v roce 2025
 - implementace ETCS do roku 2030, rok zavedení výhradního provozu vlaků pod dohledem ETCS je uveden za lomítkem
 - implementace ETCS v letech 2031 – 2033 včetně zavedení výhradního provozu vlaků pod dohledem ETCS
 - implementace ETCS v letech 2034 – 2037 včetně zavedení výhradního provozu vlaků pod dohledem ETCS
 - implementace ETCS v letech 2038 – 2040 včetně zavedení výhradního provozu vlaků pod dohledem ETCS
 - trať bez pravidelného provozu
 - trať, která není ve vlastnictví státu
- doprava
 - doprava na rozhraní terminů
 - 2023/2029 rok implementace ETCS / rok zavedení výhradního provozu vlaků pod dohledem ETCS
 - 2033 rok implementace ETCS vč. zavedení výhradního provozu vlaků pod dohledem ETCS
 - ^{*)} seznam stanic a zastánek tratí s termíny jsou uvedeny v dokumentu S2

Na mapě je zobrazeno pouze síť konvenčních železničních tratí s předpokládaným rozvojem do roku 2030

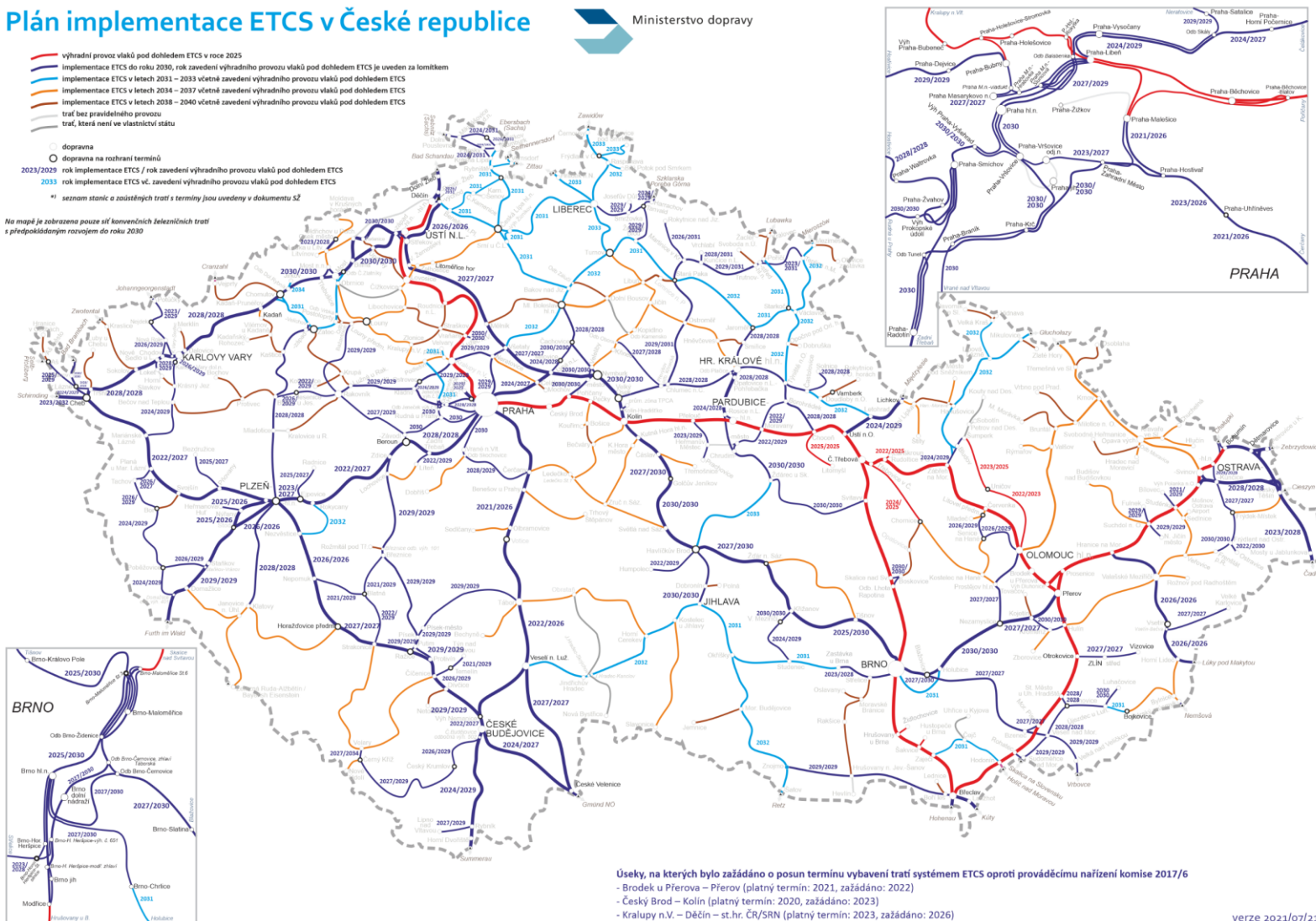

Úseky, na kterých bylo požádáno o posun termínu vybavení tratí systémem ETCS oproti prováděcímu nařízení komise 2017/6

- Brodek u Přerova – Přerov (platný termín: 2021, požádáno: 2022)
- Český Brod – Kolín (platný termín: 2020, požádáno: 2023)
- Kralupy n.V. – Děčín – st.hr. ČR/SRN (platný termín: 2023, požádáno: 2026)

verze 2021/07/21

• 9 ETCS construction plan by variants

Plán výstavby ETCS na tratích Správy železnic podle variant

- ETCS L1/L2 (Full Supervision)
- ETCS L1 Limited Supervision
- ETCS L1 Limited Supervision „STOP“
- Trať nevybavená ETCS
- Přeshraniční úseky řešeny bilaterálně
- Trať, které nejsou ve vlastnictví státu

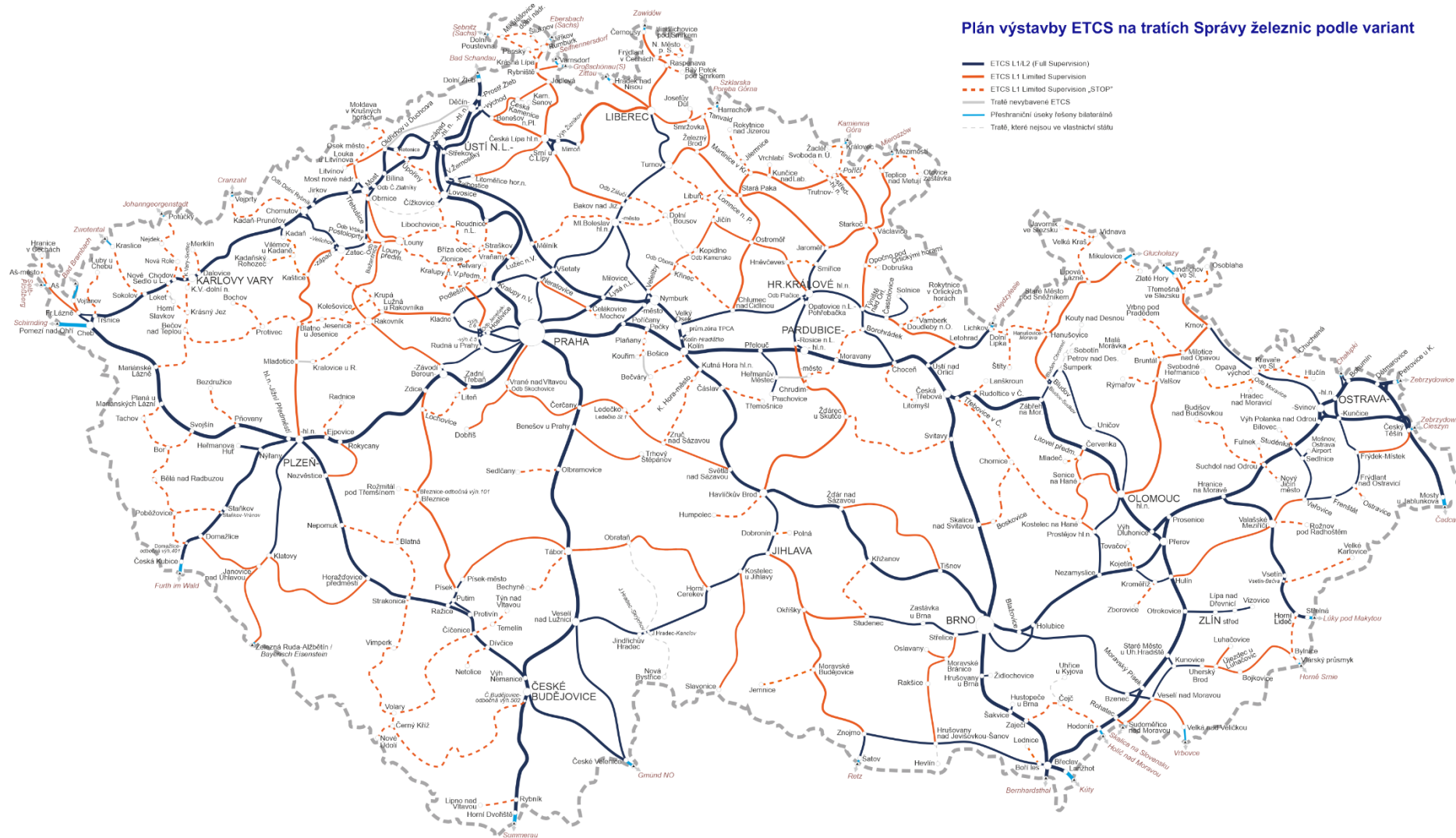

Annex "H"

List of connected lines

Legend::

1	No.	3	Name of the line
2	Line category: C – Nationwide line R – Regional line V – Siding Z – Test line	4	Connected in
		5	Organization unit of Správa železnic
		6	Infrastructure manager
		7	Contact (web, e-mail, telephone)

Seznam zaústěných drah

1	2	3	4	5	6	7
1001	V	AGRO Teplice, a.s. – vlečka Hořovice	Hořovice	Beroun	Lovochemie, a.s.	www.lovochemie.cz
1002	V	Agrochemické služby Struhařov	Struhařov	Praha hl.n.	Mydlářka a.s.	www.mydlarka.cz
1003	V	AgroZZN, a.s. - vlečka Velká Bučina	Velká Bučina	Kralupy nad Vltavou	Dr. ZENKL s.r.o.	www.drzenkl.cz
1004	V	AgroZZN, a.s. – vlečka Rakovník	Rakovník	Beroun	Dr. ZENKL s.r.o.	www.drzenkl.cz
1005	V	AgroZZN, a.s. – vlečka Hořesedly	Hořesedly	Beroun	Dr. ZENKL s.r.o.	www.drzenkl.cz
1011	V	Automot Víkava	Čachovice	Kolín	BF Logistics s.r.o.	www.bfl.cz
1013	V	ZZN Pelhřimov – Benešov u Prahy	Benešov u Prahy	Praha hl.n.	Dr. ZENKL s.r.o.	www.drzenkl.cz
1014	V	BALAK a.s.	Kralupy nad Vltavou	Kralupy nad Vltavou	"STENO, v.o.s." - stavební a inženýrská činnost v kolejové dopravě	www.stenovos.cz
1022	V	Vlečka BAEST Machinery Holding, a.s., Benešov u Pr.	Benešov u Prahy	Praha hl.n.	BAEST Machinery Holding, a.s.	www.baest.cz
1023	V	Bioenergo	Kolín	Kolín	DBV-ITL, s.r.o.	www.dbv-itl.cz
1024	V	Tereos TTD, a.s., vlečka Kolín	Kolín	Kolín	DBV-ITL, s.r.o.	www.dbv-itl.cz
1026	V	Vlečka Depozitář PVTKŽ - Vlašim	Vlašim	Praha hl.n.	PVTKŽ Benešov, s.r.o.	602 174 879
1027	V	BOLETEX Bošice	Bošice	Kolín	Česká republika - Správa státních hmotných rezerv	www.sshr.cz
1028	V	S.P.T. spol. s r.o., vlečka Dobříš	Dobříš	Praha hl.n.	DBV-ITL, s.r.o.	www.dbv-itl.cz

1	2	3	4	5	6	7
1032	V	CBU – Yard	Hradištko-průmyslová zóna	Kolín	ČD Cargo, a.s.	www.cdcargo.cz
1033	V	Cihelna Libčice	Libčice nad Vltavou	Kralupy nad Vltavou	"STENO, v.o.s." - stavební a inženýrská činnost v kolejové dopravě	www.stenovos.cz
1036	V	Crystal BOHEMIA, a.s., vlečka Poděbrady	Poděbrady	Kolín	DBV-ITL, s.r.o.	www.dbv-itl.cz
1037	V	CTY KOMOŘANSKÁ	Praha-Modřany	Praha hl.n.	Dr. ZENKL s.r.o.	www.drzenkl.cz
1041	V	Cukrovar Ratboř	Ratboř	Kolín	DBV-ITL, s.r.o.	www.dbv-itl.cz
1044	V	Cukrovar Zvoleněves	Zvoleněves	Kralupy nad Vltavou	Dr. ZENKL s.r.o.	www.drzenkl.cz
1045	V	Cukrovar TTD – Dobruška	Dobruška	Kolín	BF Logistics s.r.o.	www.bfl.cz
1046	V	Čáslav pila	Čáslav	Kolín	"STENO, v.o.s." - stavební a inženýrská činnost v kolejové dopravě	www.stenovos.cz
1048	V	ČEPS, a.s. – vlečka Čechy střed	Čelákovice - Mochov	Kolín	DBV-ITL, s.r.o.	www.dbv-itl.cz
1049	V	Čertovy schody	Beroun	Beroun	Velkolom Čertovy schody, akciová společnost	www.lhoist.com
1050	V	České lupkové závody, a.s.	Nové Strašecí	Beroun	HK spol. s r.o.	mira.hubka@volny.cz
1051	V	Českomoravský cement, a.s., závod Králův Dvůr I (KDC I)	Beroun	Beroun	Českomoravský cement, a.s.	www.heidelbergcement.cz
1052	V	Českomoravský cement, a.s., závod Praha Radotín	Praha-Radotín	Praha hl.n.	Českomoravský cement, a.s.	www.heidelbergcement.cz
1056	V	ČSL-Středokluky	Středokluky	Kralupy nad Vltavou	Letiště Praha, a. s.	www.prg.aero
1057	V	DAKO a.s.	Třemošnice	Kolín	GJW Praha spol. s r.o.	www.gjw-praha.cz
1058	V	DLT Kladno	Kladno-Dubí	Kralupy nad Vltavou	PKP CARGO INTERNATIONAL a.s.	www.pkpcargointernational.com
1059	V	DOBOS s r.o.	Dolní Bousov	Kolín	JIPOK, s.r.o.	jipok.sro@volny.cz
1061	V	Vlečka DYKO	Kolín	Kolín	DBV-ITL, s.r.o.	www.dbv-itl.cz
1062	V	DYWIDAG PREFA	Lysá nad Labem	Kolín	"STENO, v.o.s." - stavební a inženýrská činnost v kolejové dopravě	www.stenovos.cz
1063	V	DZ Zdice	Zdice	Beroun	"STENO, v.o.s." - stavební a inženýrská činnost v kolejové dopravě	www.stenovos.cz
1065	V	Elektrárna Kolín	Kolín	Kolín	DBV-ITL, s.r.o.	www.dbv-itl.cz
1068	V	Vlečka EUROVIA KAMENOLOMY, a.s., Středokluky	Středokluky	Kralupy nad Vltavou	EUROVIA CS, a.s.	www.eurovia.cz
1070	V	EŽ Praha a.s. – Velký Osek	Velký Osek	Kolín	Elektrizace železnic Praha a.s.	www.elzel.cz
1073	V	Vlečka HASE elektronik s.r.o. Kolín	Kolín	Kolín	DBV-ITL, s.r.o.	www.dbv-itl.cz
1078	V	FM ČESKÁ Tuchoměřice	Středokluky - Noutonice	Kralupy nad Vltavou	WPC FM Czech s.r.o.	www.fmlogistic.cz
1079	V	FREMIS, a.s. – vlečka Vlašim	Vlašim	Praha hl.n.	DBV-ITL, s.r.o.	www.dbv-itl.cz
1080	V	FV – Plast, a.s. Čelákovice	Čelákovice	Kolín	"STENO, v.o.s." - stavební a inženýrská činnost v kolejové dopravě	www.stenovos.cz
1081	V	Garage Development	Praha-Smíchov	Praha hl.n.	"STENO, v.o.s." - stavební a inženýrská činnost v kolejové dopravě	www.stenovos.cz

1	2	3	4	5	6	7
1082	V	GUTEWAY INVEST s.r.o.	Úžice	Kralupy nad Vltavou	"STENO, v.o.s." - stavební a inženýrská činnost v kolejové dopravě	www.stenovos.cz
1083	V	GEFCO-HUB	Hradištko-průmyslová zóna	Kolín	ČD Cargo, a.s.	www.cdcargo.cz
1084	V	Goldbeck Prefabeton s.r.o. Skovice	Skovice	Kolín	ČD Cargo, a.s.	www.cdcargo.cz
1085	V	HÖDLMAYR Č.R. a.s.	Jeneč	Kralupy nad Vltavou	Marcela Čechová	cech.oto@quick.cz
1089	V	JAWA Moto spol. s r.o., vlečka Týnec nad Sázavou	Týnec nad Sázavou	Praha hl.n.	DBV-ITL, s.r.o.	www.dbv-itl.cz
1090	V	JHJ Otovice	Otovice	Kralupy nad Vltavou	"STENO, v.o.s." - stavební a inženýrská činnost v kolejové dopravě	www.stenovos.cz
1091	V	TEDOP s.r.o.	Čáslav	Kolín	TEDOP s.r.o.	www.tedop.cz
1092	V	KAVALIERGLASS, a.s., vlečka Růženín	Samechov	Kolín	DBV-ITL, s.r.o.	www.dbv-itl.cz
1093	V	KAVALIERGLASS, a.s., vlečka Sázava	Sázava	Kolín	DBV-ITL, s.r.o.	www.dbv-itl.cz
1094	V	KERACLAY Nehvizdy	Mstětice	Praha hl.n.	DBV-ITL, s.r.o.	www.dbv-itl.cz
1095	V	SSHR Vinařice	Kladno-Dubí	Kralupy nad Vltavou	Dr. ZENKL s.r.o.	www.drzenkl.cz
1098	V	Kolínský ISOL, s.r.o., vlečka APA	Kolín	Kolín	DBV-ITL, s.r.o.	www.dbv-itl.cz
1099	V	KOVO SDS, vlečka Zdice	Zdice	Beroun	DBV-ITL, s.r.o.	www.dbv-itl.cz
1101	V	KOVONA, a.s.	Lysá nad Labem	Kolín	KŽC Doprava, s.r.o.	www.kzc.cz
1102	V	KOVOŠROT GROUP CZ s.r.o. - vlečka Mělník	Mělník	Kralupy nad Vltavou	Dr. ZENKL s.r.o.	www.drzenkl.cz
1106	V	Důl Libušín	Kamenné Žehrovice	Beroun	Railway Capital a.s.	www.railwaycapital.cz
1109	V	LIMA – eko služby s.r.o. vlečka Zruč nad Sázavou	Zruč nad Sázavou	Kolín	Provozování dráhy, kolejové stavby a servis Tomáš Brýda	tomas.bryda@gmail.com
1111	V	LITRA Mnichovo Hradiště	Mnichovo Hradiště	Kolín	"STENO, v.o.s." - stavební a inženýrská činnost v kolejové dopravě	www.stenovos.cz
1112	V	Lomy Mořina	Nučice	Beroun	LOMY MOŘINA spol. s r.o.	www.lomy-morina.cz
1113	V	Lubomír Batelka, vlečka Úvaly	Úvaly	Kolín	DBV-ITL, s.r.o.	www.dbv-itl.cz
1114	V	Maersk Logistics, vlečka Hostivice	Praha-Ruzyně - Hostivice	Kralupy nad Vltavou	"STENO, v.o.s." - stavební a inženýrská činnost v kolejové dopravě	www.stenovos.cz
1115	V	AZOS	Nymburk město	Kolín	PKP CARGO INTERNATIONAL a.s.	www.pkpcargointernational.com
1117	V	MEFRIT Mělník	Mělník	Kralupy nad Vltavou	DBV-ITL, s.r.o.	www.dbv-itl.cz
1118	V	Městská vlečka Praha-Čakovice	Praha-Čakovice	Praha hl.n.	Dr. ZENKL s.r.o.	www.drzenkl.cz
1119	V	METAL TRADE COMAX, s.r.o., vlečka Velvary	Velvary	Kralupy nad Vltavou	DBV-ITL, s.r.o.	www.dbv-itl.cz
1124	V	METRANS, a.s.	Praha-Uhřetěves	Praha hl.n.	METRANS, a.s.	www.metrans.eu
1125	V	METRO – vlečka do depa Kačerov	Praha-Krč	Praha hl.n.	Dopravní podnik hl. m. Prahy, akciová společnost	www.dpp.cz

1	2	3	4	5	6	7
1126	V	Metrostav – Praha - Horní Počernice	Praha-Horní Počernice	Praha hl.n.	JIPOK, s.r.o.	jipok.sro@volny.cz
1127	V	Mi-King s.r.o., K Dílnám, Kolín	Kolín	Kolín	DBV-ITL, s.r.o.	www.dbv-itl.cz
1128	V	Minerální vody Jiří V.Černý	Praha-Vršovice	Praha hl.n.	JIPOK, s.r.o.	jipok.sro@volny.cz
1130	V	MOKATE Czech Olbramovice	Olbramovice	Praha hl.n.	Dr. ZENKL s.r.o.	www.drzenkl.cz
1131	V	AUTO HP Kutná Hora	Kutná Hora hl.n.	Kolín	DBV-ITL, s.r.o.	www.dbv-itl.cz
1136	V	MTH Kladno	Kladno	Kralupy nad Vltavou	"STENO, v.o.s." - stavební a inženýrská činnost v kolejové dopravě	www.stenovos.cz
1137	V	Mydlářka Trhový Štěpánov	Trhový Štěpánov	Praha hl.n.	Mydlářka a.s.	www.mydlarka.cz
1148	V	OKV Nymburk	Nymburk hl.n.	Kolín	ČD Cargo, a.s.	www.cdcargo.cz
1154	V	SKD TRADE, a.s. vlečka Žleby	Žleby	Kolín	DBV-ITL, s.r.o.	www.dbv-itl.cz
1155	V	PALIVA SEDLČANY	Sedlčany	Praha hl.n.	PALIVA SEDLČANY s.r.o.	www.palivasedlcany.cz
1158	V	LB Cemix, závod Loděnice	Loděnice	Beroun	Českomoravský cement, a.s.	www.heidelbergcement.cz
1159	V	Philips Morris ČR a.s., vlečka Kutná Hora	Kutná Hora hl.n.	Kolín	ALLCORA, s.r.o.	www.allcora.cz
1162	V	ZITEK Praha – Radotín	Praha-Radotín	Praha hl.n.	Dr. ZENKL s.r.o.	www.drzenkl.cz
1163	V	POLORA, Polerady nad Labem	Polerady nad Labem	Kralupy nad Vltavou	Česká republika - Správa státních hmotných rezerv	www.sshr.cz
1167	V	RAVEN CZ Strančice	Strančice	Praha hl.n.	Dr. ZENKL s.r.o.	www.drzenkl.cz
1168	V	Vera Gloria s.r.o.	Dymokury	Hradec Králové	DBV-ITL, s.r.o.	www.dbv-itl.cz
1173	V	PRKO - Strančice	Strančice	Praha hl.n.	Dr. ZENKL s.r.o.	www.drzenkl.cz
1174	V	Procter & Gamble - Rakona, s.r.o.	Rakovník - Mladotice	Beroun	ČD Cargo, a.s.	www.cdcargo.cz
1181	V	Satalice truhlárna	Praha-Satalice	Praha hl.n.	"STENO, v.o.s." - stavební a inženýrská činnost v kolejové dopravě	www.stenovos.cz
1182	V	SCREWS & WIRE Libčice a.s.	Libčice nad Vltavou	Kralupy nad Vltavou	"STENO, v.o.s." - stavební a inženýrská činnost v kolejové dopravě	www.stenovos.cz
1186	V	TOTAL ČESKÁ REPUBLIKA s.r.o., vlečka Kouřim	Kouřim	Kolín	DBV-ITL, s.r.o.	www.dbv-itl.cz
1187	V	Sílo Ronov s.r.o., vlečka Ronov nad Doubravou	Ronov nad Doubravou	Kolín	DBV-ITL, s.r.o.	www.dbv-itl.cz
1189	V	Skanska a.s. - vlečka montážní základna Kralupy nad Vltavou	Kralupy nad Vltavou	Kralupy nad Vltavou	Skanska a.s.	www.skanska.cz
1191	V	Skanska a.s. - vlečka Praha Hostivař	Praha-Hostivař	Praha hl.n.	Skanska a.s.	www.skanska.cz
1192	V	Skladový areál MR Čáslav	Čáslav	Kolín	Lesy České republiky, s.p.	www.lesy-cr.cz
1193	V	Sladovny Soufflet, závod Nymburk	Nymburk město	Kolín	IDS Cargo a.s.	www.ids-cargo.cz
1196	V	SPOLEČNOST KOLEJOVÝCH VOZIDEL s.r.o., areál ZLIČÍN	Praha-Zličín	Praha hl.n.	NOR a.s.	www.nor.cz

1	2	3	4	5	6	7
1197	V	Správa a údržba silnic Pardubického kraje, vlečka Třemošnice	Třemošnice	Kolín	DBV-ITL, s.r.o.	www.dbv-itl.cz
1199	V	SSQ Property a.s., vlečka Kolín	Kolín	Kolín	DBV-ITL, s.r.o.	www.dbv-itl.cz
1202	V	Stará vlečka	Praha-Zličín	Praha hl.n.	Marcela Čechová	cech.oto@quick.cz
1209	V	ŠKODA AUTO a.s.- Mladá Boleslav	Mladá Boleslav město	Kolín	Pirell s.r.o.	www.pirell.cz
1212	V	PRAGORENT Praha-Horní Počernice	Horní Počernice	Praha hl.n.	Dr. ZENKL s.r.o.	www.drzenkl.cz
1214	V	TOPEK-Oil.cz, a.s. vlečka Červené Pečky	Červené Pečky	Kolín	Dr. ZENKL s.r.o.	www.drzenkl.cz
1216	V	TROJEK, s.r.o., vlečka Kolín	Kolín	Kolín	DBV-ITL, s.r.o.	www.dbv-itl.cz
1222	V	Obec Strančice	Strančice	Praha hl.n.	Dr. ZENKL s.r.o.	www.drzenkl.cz
1226	V	UNIKOM a.s. – vlečka Uhlířské Janovice	Uhlířské Janovice	Kolín	CityRail, a.s.	www.cityrail.cz
1227	V	NESALUKA	Nelahozeves	Kralupy nad Vltavou	ALLCORA, s.r.o.	www.allcora.cz
1229	V	Vlečka a.s. ZZ Plzeň, provoz Kralovice	Kralovice	Beroun	Dr. ZENKL s.r.o.	www.drzenkl.cz
1231	V	Vlečka – přístav Kolín	Kolín	Kolín	České přístavy, a.s.	www.ceskepristavy.cz
1232	V	Vlečka - přístav Mělník	Mělník	Kralupy nad Vltavou	České přístavy, a.s.	www.ceskepristavy.cz
1235	V	Vlečka A.Z. – Hostivice	Hostivice	Kralupy nad Vltavou	A.ZADÁK - STAV., spol. s r.o.	www.azadakstav.cz
1236	V	Vlečka AGP-Beroun-Závodí	Beroun-Závodí	Beroun	"STENO, v.o.s." - stavební a inženýrská činnost v kolejové dopravě	www.stenovos.cz
1237	V	Vlečka Agrodružstvo Katusice	Katusice	Kolín	DBV-ITL, s.r.o.	www.dbv-itl.cz
1241	V	Vlečka ARS ALTMANN Lysá nad Labem	Lysá nad Labem	Kolín	Jitka OTAVOVÁ	karelotava@centrum.cz
1244	V	Vlečka Avia a.s.	Praha-Čakovice	Praha hl.n.	"STENO, v.o.s." - stavební a inženýrská činnost v kolejové dopravě	www.stenovos.cz
1249	V	Speedtrans rail s.r.o.	Kolín	Kolín	BF Logistics s.r.o.	www.bfl.cz
1251	V	Vlečka BSS METACO a.s.	Brandýs nad Labem - Toušeň	Kralupy nad Vltavou	Dr. ZENKL s.r.o.	www.drzenkl.cz
1253	V	Vlečka CEMBRIT Beroun – Závodí	Beroun-Závodí	Beroun	DBV-ITL, s.r.o.	www.dbv-itl.cz
1261	V	Cintlovka Hořovice	Hořovice	Beroun	BF Logistics s.r.o.	www.bfl.cz
1262	V	Vlečka ČKD Kutná Hora	Kutná Hora hl.n.	Kolín	CityRail, a.s.	www.cityrail.cz
1264	V	Vlečka ČKD Slaný	Podlešín - Slaný	Kralupy nad Vltavou	KOLSTAV - KRALUPY s.r.o.	kolstav@quick.cz
1266	V	Vlečka Lom Krhanice	Krhanice - Jílové u Prahy	Praha hl.n.	Pirell s.r.o.	www.pirell.cz
1267	V	Vlečka Draslovka Kolín	Kolín	Kolín	DBV-ITL, s.r.o.	www.dbv-itl.cz
1268	V	OK Třebestovice	Třebestovice	Kolín	DBV-ITL, s.r.o.	www.dbv-itl.cz
1270	V	Vlečka firmy Ing. František Hustoles, areál Rudná u Prahy, Masarykova ulice č.p.921	Rudná u Prahy	Beroun	HK spol. s r.o.	mira.hubka@volny.cz

1	2	3	4	5	6	7
1273	V	Q Park Měšice	Měšice u Prahy	Kralupy nad Vltavou	Marcela Čechová	cech.oto@quick.cz
1277	V	Vlečka Josef Petzold, Poděbrady	Poděbrady	Kolín	JIPOK, s.r.o.	jipok.sro@volny.cz
1278	V	Vlečka LINDAB Hostivice	Praha-Ruzyně - Hostivice	Kralupy nad Vltavou	ALLCORA, s.r.o.	www.allcora.cz
1279	V	Vlečka Kaučuk SKP Úžice	Úžice	Kralupy nad Vltavou	ORLEN Unipetrol Doprava s.r.o.	www.orlenunipetroldoprava.cz
1280	V	Vlečka Kaučuk, základní závod	Chvatěruby	Kralupy nad Vltavou	ORLEN Unipetrol Doprava s.r.o.	www.orlenunipetroldoprava.cz
1281	V	Vlečka KD Trans s.r.o.	Beroun	Beroun	KD Trans s.r.o.	www.kdtrans.cz
1282	V	Vlečka Kněževs	Kněževs	Beroun	HERKULES KHKD s.r.o.	www.khkd.cz
1285	V	Vlečka KOPOS KOLÍN a.s.	Kolín	Kolín	DBV-ITL, s.r.o.	www.dbv-itl.cz
1288	V	REGIOJET Praha-Hostivař	Praha-Hostivař	Praha hl.n.	Dr. ZENKL s.r.o.	www.drzenkl.cz
1289	V	Vlečka Kovošrot Rakovník	Rakovník - Chrášťany	Beroun	"STENO, v.o.s." - stavební a inženýrská činnost v kolejové dopravě	www.stenovos.cz
1291	V	Vlečka Kuklovi	Středokluky	Kralupy nad Vltavou	"STENO, v.o.s." - stavební a inženýrská činnost v kolejové dopravě	www.stenovos.cz
1292	V	Vlečka LASSELSBERGER, a.s. - Rakovník 3	Lubná	Beroun	Dr. ZENKL s.r.o.	www.drzenkl.cz
1293	V	Vlečka LASSELSBERGER, a.s. - Rakovník 1	Praha-Bubny - Rakovník	Beroun	Dr. ZENKL s.r.o.	www.drzenkl.cz
1296	V	Vlečka Lučební	Kolín	Kolín	DBV-ITL, s.r.o.	www.dbv-itl.cz
1297	V	Trelleborg Wheel Systems Czech Republic a.s.	Praha-Zahradní město	Praha hl.n.	ČD Cargo, a.s.	www.cdcargo.cz
1298	V	Vlečka Mstětice	Mstětice	Praha hl.n.	"STENO, v.o.s." - stavební a inženýrská činnost v kolejové dopravě	www.stenovos.cz
1299	V	Vlečka BRENNTAG Praha	Praha-Horní Počernice	Praha hl.n.	Brenntag CR s.r.o.	www.brenntag.cz
1304	V	Vlečka Pivovar Velké Popovice	Strančice	Praha hl.n.	"STENO, v.o.s." - stavební a inženýrská činnost v kolejové dopravě	www.stenovos.cz
1305	V	Vlečka Podaný	Praha-Krč	Praha hl.n.	RUTR, spol. s r.o.	www.rutr.cz
1306	V	Roztoky	Roztoky u Křivoklátu	Beroun	Ing. Jan DUDÁČEK	jandudacek@seznam.cz
1307	V	Vlečka sklad Domašín - Most	Domašín	Praha hl.n.	PVTKŽ Benešov, s.r.o.	602 174 879
1310	V	Vlečka Prefa Brandýs n/L.	Lázně Toušeň	Kolín	Dr. ZENKL s.r.o.	www.drzenkl.cz
1311	V	Vlečka Preymesser Řepov	Mladá Boleslav město	Kolín	M.Preymesser logistika, spol. s r.o.	www.preymesser.cz
1312	V	Porr a.s. Středokluky	Středokluky	Kralupy nad Vltavou	ČD Cargo, a.s.	www.cdcargo.cz
1317	V	Vlečka SD KOVO Mladá Boleslav město	Mladá Boleslav město	Kolín	Pirell s.r.o.	www.pirell.cz
1321	V	Areál Vraňany	Vraňany	Kralupy nad Vltavou	Dr. ZENKL s.r.o.	www.drzenkl.cz
1323	V	Vlečka Spolana a.s. Neratovice	Neratovice	Kralupy nad Vltavou	ORLEN Unipetrol Doprava s.r.o.	www.orlenunipetroldoprava.cz
1326	V	Vlečka FERTISTAV CZ Městec Králové	Městec Králové	Hradec Králové	Ing. Miroslav Holubář	www.provozdrah.cz

1	2	3	4	5	6	7
1327	V	Vlečka Teplárna Holešovice	Praha-Holešovice	Praha hl.n.	EP Cargo a.s.	www.epcargo.cz
1328	V	Vlečka Teplárna Malešice	Praha-Malešice	Praha hl.n.	EP Cargo a.s.	www.epcargo.cz
1332	V	Vlečka TOS Čelákovice	Čelákovice	Kolín	Dr. ZENKL s.r.o.	www.drzenkl.cz
1334	V	Vlečka TREX-MB Debř	Mladá Boleslav - Debř	Kolín	Ing. Miroslav Holubář	www.provozdrah.cz
1335	V	Vlečka TRUCKPARK Loukov	Loukov u Mnichova Hradiště	Kolín	Ing. Miroslav Holubář	www.provozdrah.cz
1337	V	Vlečka Variel a.s., Zruč nad Sázavou	Zruč nad Sázavou	Kolín	GJW Praha spol. s r.o.	www.gjw-praha.cz
1338	V	Vitana Byšice	Byšice	Kralupy nad Vltavou	ALLCORA, s.r.o.	www.allcora.cz
1339	V	Vlečka výtah	Kolín	Kolín	DBV-ITL, s.r.o.	www.dbv-itl.cz
1340	V	ZZN Polabí, a.s. - vlečka Mělník	Mělník	Kralupy nad Vltavou	ZZN Polabí, a.s.	www.zznpolabi.cz
1342	V	Vlečka ZPA Pečky, a.s.	Pečky	Kolín	DBV-ITL, s.r.o.	www.dbv-itl.cz
1343	V	AgroZZN a.s. - vlečka Slaný	Slaný	Kralupy nad Vltavou	Dr. ZENKL s.r.o.	www.drzenkl.cz
1344	V	Vlečka NYMWAG Nymburk	Nymburk hl.n.	Kolín	Raeder & Falge s.r.o.	www.raeder-falge.cz
1345	V	Vojenská vlečka č. 10 – Čáslav	Čáslav	Kolín	Armádní Servisní, příspěvková organizace	www.as-po.cz
1347	V	Vlečka VTOS s.r.o. Mnichovo Hradiště	Mnichovo Hradiště	Kolín	PRODRA s.r.o.	www.prodra.cz
1349	V	BK-Praha-Uhřetěves	Praha-Uhřetěves	Praha hl.n.	Dr. ZENKL s.r.o.	www.drzenkl.cz
1354	V	WESTPOINT DISTRIBUTION PARK, Praha-Ruzyně	Praha-Ruzyně	Praha hl.n.	Dr. ZENKL s.r.o.	www.drzenkl.cz
1360	V	ZEMPOMARKET a.s. Bečváry	Bošice - Bečváry	Kolín	ZEMPOMARKET a.s. Bečváry	www.zempo.cz
1361	V	ZZN Polabí, a.s. - vlečka Chotětov	Chotětov	Kralupy nad Vltavou	ZZN Polabí, a.s.	www.zznpolabi.cz
1362	V	ZZN Polabí, a.s. - vlečka Kněžmost	Bakov nad Jizerou - Dolní Bousov	Kolín	ZZN Polabí, a.s.	www.zznpolabi.cz
1369	V	ZZN Polabí, a.s. - vlečka Byšice	Byšice	Kralupy nad Vltavou	ZZN Polabí, a.s.	www.zznpolabi.cz
1370	V	ZZN Polabí, a.s. - vlečka Měšice	Měšice u Prahy	Kralupy nad Vltavou	ZZN Polabí, a.s.	www.zznpolabi.cz
1372	V	ZZN Polabí, a.s. - vlečka Křinec	Křinec	Liberec	ZZN Polabí, a.s.	www.zznpolabi.cz
1373	V	ZZN Polabí, a.s. - vlečka Lysá nad Labem	Lysá nad Labem	Kolín	ZZN Polabí, a.s.	www.zznpolabi.cz
1374	V	ZZN Polabí, a.s. - vlečka Městec Králové	Městec Králové	Hradec Králové	ZZN Polabí, a.s.	www.zznpolabi.cz
1375	V	ZZN Polabí, a.s. - vlečka Pečky	Pečky	Kolín	ZZN Polabí, a.s.	www.zznpolabi.cz
1377	V	ZZN Polabí, a.s. - vlečka Kolín	Kolín	Kolín	ZZN Polabí, a.s.	www.zznpolabi.cz
1378	V	ZZN Pelhřimov - Zdislavice	Zdislavice	Praha hl.n.	Dr. ZENKL s.r.o.	www.drzenkl.cz
1383	V	ZZN Polabí, a.s. - vlečka Kouřim	Kouřim	Kolín	ZZN Polabí, a.s.	www.zznpolabi.cz
1385	V	ŽPSV a.s. závod Čerčany	Čerčany	Praha hl.n.	Pirell s.r.o.	www.pirell.cz
1388	V	Depo Bakov nad Jizerou	Bakov nad Jizerou	Kolín	Puš s.r.o.	www.pussro.cz
1389	V	Havelka Křinec	Křinec	Liberec	DBV-ITL, s.r.o.	www.dbv-itl.cz
1390	V	Depo Benešov	Benešov u Prahy	Praha hl.n.	Posázavský Pacifik - doprava s.r.o.	www.posazavsky-pacifik.cz

1	2	3	4	5	6	7
1391	V	Výtopna Zruč	Zruč nad Sázavou	Kolín	Posázavský Pacifik - doprava s.r.o.	www.posazavsky-pacifik.cz
1392	V	Vlečka MBŽS Skalsko 2	Skalsko	Kolín	MBM rail s.r.o.	www.mbmr.cz
1393	V	Vlečka MBŽS Skalsko	Skalsko	Kolín	MBM rail s.r.o.	www.mbmr.cz
1394	V	Vrané River	Vrané nad Vltavou	Praha hl.n.	ALLCORA, s.r.o.	www.allcora.cz
1395	V	Výtopna Zdice	Zdice	Beroun	MBM rail s.r.o.	www.mbmr.cz
1396	V	Depo	Pečky	Kolín	DBV-ITL, s.r.o.	www.dbv-itl.cz
1397	V	Vlečka RSM Pečky	Pečky	Kolín	České dráhy, a.s.	www.ceskedrahy.cz
1399	V	Vlečka RSM Velký Osek	Velký Osek	Kolín	České dráhy, a.s.	www.ceskedrahy.cz
1400	V	ZABABA s.r.o.	Praha-Smíchov	Praha hl.n.	ZABABA, s.r.o.	www.masinka.cz
1401	V	Českomoravský cement, a.s., závod Králův Dvůr II (KDC II)	Beroun	Beroun	Českomoravský cement, a.s.	www.heidelbergcement.cz
1402	V	ČD, a.s. - Kladno	Kladno	Kralupy nad Vltavou	České dráhy, a.s.	www.ceskedrahy.cz
1405	V	RSM Praha, ŽST Kolín m.n.	Kolín	Kolín	České dráhy, a.s.	www.ceskedrahy.cz
1406	V	ČD, a.s. - CHV Lužná u Rakovníka	Lužná u Rakovníka	Beroun	České dráhy, a.s.	www.ceskedrahy.cz
1408	V	ČD, a.s. - Trhový Štěpánov	Trhový Štěpánov	Praha hl.n.	České dráhy, a.s.	www.ceskedrahy.cz
1409	V	ČD, a.s. - Třemošnice	Třemošnice	Kolín	České dráhy, a.s.	www.ceskedrahy.cz
1410	V	ČD, a.s. - Sedlčany	Sedlčany	Praha hl.n.	České dráhy, a.s.	www.ceskedrahy.cz
1411	V	ČD, a.s. - Rakovník	Rakovník	Beroun	České dráhy, a.s.	www.ceskedrahy.cz
1412	V	ČD, a.s. - Olbramovice	Olbramovice	Praha hl.n.	České dráhy, a.s.	www.ceskedrahy.cz
1413	V	ČD, a.s. - Čáslav	Čáslav	Kolín	České dráhy, a.s.	www.ceskedrahy.cz
1414	V	ČD, a.s. - Pečky	Pečky	Kolín	České dráhy, a.s.	www.ceskedrahy.cz
1415	V	ČD, a.s. - Nymburk	Nymburk hl.n.	Kolín	České dráhy, a.s.	www.ceskedrahy.cz
1416	V	KOCHMANTRANS s.r.o.	Kralupy nad Vltavou	Kralupy nad Vltavou	KOLSTAV - KRALUPY s.r.o.	kolstav@quick.cz
1417	V	ČD, a.s. - Kralupy nad Vltavou	Kralupy nad Vltavou	Kralupy nad Vltavou	České dráhy, a.s.	www.ceskedrahy.cz
1418	V	RSM Praha, ŽST Byšice	Byšice	Kralupy nad Vltavou	České dráhy, a.s.	www.ceskedrahy.cz
1419	V	RSM Praha, ŽST Kolín	Kolín	Kolín	ČD Cargo, a.s.	www.cdcargo.cz
1420	V	RSM Praha, ŽST Kralupy nad Vltavou	Kralupy nad Vltavou	Kralupy nad Vltavou	České dráhy, a.s.	www.ceskedrahy.cz
1421	V	ČD, a.s. - Benešov u Prahy	Benešov u Prahy	Praha hl.n.	České dráhy, a.s.	www.ceskedrahy.cz
1422	V	ČD, a.s. - Čerčany	Čerčany	Praha hl.n.	České dráhy, a.s.	www.ceskedrahy.cz
1423	V	ČD, a.s. - Mladá Boleslav	Mladá Boleslav hl.n.	Kolín	České dráhy, a.s.	www.ceskedrahy.cz
1424	V	ČD, a.s. - Praha Libeň	Praha-Libeň	Praha hl.n.	České dráhy, a.s.	www.ceskedrahy.cz
1425	V	ČD, a.s. - Beroun	Beroun	Beroun	České dráhy, a.s.	www.ceskedrahy.cz
1426	V	ČD, a.s. - Kolín	Kolín	Kolín	České dráhy, a.s.	www.ceskedrahy.cz
1427	V	ČD, a.s. - Praha Vršovice	Praha-Vršovice	Praha hl.n.	České dráhy, a.s.	www.ceskedrahy.cz
1428	V	Vlečka NTM Praha, Masarykovo nádraží	Praha Masarykovo nádraží	Praha hl.n.	RUTR, spol. s r.o.	www.rutr.cz
1431	V	Vlečka HASE elektronik s.r.o. Kolín I	Kolín	Kolín	DBV-ITL, s.r.o.	www.dbv-itl.cz
1432	V	ČD, a.s. - Kutná Hora	Kutná Hora hl.n.	Kolín	České dráhy, a.s.	www.ceskedrahy.cz

1	2	3	4	5	6	7
1433	V	ČD, a.s. - Kácov	Kácov	Kolín	České dráhy, a.s.	www.ceskedrahy.cz
1902	V	VČS Beroun	Beroun	Beroun	Vápenka Čertovy schody a.s.	www.lhoist.com
1903	V	Kámen Zbraslav	Středokluky	Kralupy nad Vltavou	Dr. ZENKL s.r.o.	www.drzenkl.cz
2001	V	AGPI Milevsko	Milevsko	Tábor	Dr. ZENKL s.r.o.	www.drzenkl.cz
2002	V	Vlečka AGRO Blatná a.s.	Rokycany	Plzeň	AGRO Blatná a.s.	www.agroblatna.cz
2003	V	Vlečka AGRO Radomyšl	Radomyšl	Tábor	EDOP s.r.o.	v.kamba@tiscali.cz
2005	V	Agropodnik Strunkovice n. Blanicí	Strunkovice nad Blanicí	České Budějovice	Dr. ZENKL s.r.o.	www.drzenkl.cz
2006	V	Primagra, a.s. - vlečka Mutěnin	Mutěnin	Plzeň	Primagra, a.s.	www.primagra.cz
2007	V	Primagra, a.s. - vlečka Bor	Bor	Plzeň	Primagra, a.s.	www.primagra.cz
2008	V	Primagra, a.s. - vlečka Domažlice	Domažlice	Plzeň	Primagra, a.s.	www.primagra.cz
2009	V	Primagra, a.s. - vlečka Horažďovice	Horažďovice	Plzeň	Primagra, a.s.	www.primagra.cz
2011	V	Primagra, a.s. - vlečka Planá	Planá u Mariánských Lázní	Plzeň	Primagra, a.s.	www.primagra.cz
2013	V	Primagra, a.s. - vlečka Staré Sedliště	Staré Sedliště	Plzeň	Primagra, a.s.	www.primagra.cz
2014	V	Primagra, a.s. - vlečka Točnick	Horažďovice	Plzeň	Primagra, a.s.	www.primagra.cz
2015	V	Primagra, a.s. - vlečka Trpísty	Trpísty	Plzeň	Primagra, a.s.	www.primagra.cz
2016	V	Agrowest, OTP Klatovy	Klatovy	Plzeň	Agrowest a.s.	www.agrowest.com
2017	V	Primagra, a.s. - vlečka Sušice	Sušice	Plzeň	Primagra, a.s.	www.primagra.cz
2024	V	BRAMAC, vlečka Protivín	Protivín	České Budějovice	DBV-ITL, s.r.o.	www.dbv-itl.cz
2026	V	Budvar České Budějovice	Nemanice	České Budějovice	Budějovický Budvar, národní podnik	www.budejovickybudvar.cz
2027	V	Cihelna Blovice	Blovice	Plzeň	CE WOOD, a.s.	jiri@ostravsky.cz
2028	V	Českomoravský štěrk, a.s.-vlečka pískovna Chlum u Třeboně	Majdalena	Tábor	Českomoravský cement, a.s.	www.heidelbergcement.cz
2029	V	ČEZ, a.s. - jaderná elektrárna Temelín	Temelín	České Budějovice	ČEZ, a.s.	www.cez.cz
2030	V	ČZ Strakonice	Strakonice	České Budějovice	Dopravní a inženýrské služby s.r.o.	www.k-buildingcb.cz
2031	V	DIAMO - Mydlovary	Dívčice	České Budějovice	DIAMO, státní podnik	www.diamo.cz
2033	V	Vlečka DIOSS NÝŘANY	Nýřany	Plzeň	Dr. ZENKL s.r.o.	www.drzenkl.cz
2034	V	DOČEŠ Jarošov nad Nežárkou	Jarošov nad Nežárkou	Tábor	Dr. ZENKL s.r.o.	www.drzenkl.cz
2035	V	E.ON., Tepłárna Mydlovary	Zliv	České Budějovice	Dopravní a inženýrské služby s.r.o.	www.k-buildingcb.cz
2036	V	Elektropřístroj Písek	Písek město	Tábor	"STENO, v.o.s." - stavební a inženýrská činnost v kolejové dopravě	www.stenovos.cz
2038	V	Ferona, a.s. vlečka Plzeň	Plzeň hl.n.	Plzeň	Ferona, a.s.	www.ferona.cz
2042	V	HASIT Šumavské vápenice a omítkárny	Velké Hydčice	Plzeň	Antonín Krejčí	ant.krejci@seznam.cz
2043	V	Pfeifer Holz	Pačejov	České Budějovice	Železniční projekčně-stavební kancelář s.r.o.	www.zpk-ds.cz
2045	V	I.P.P.E. s.r.o.	Chrást u Plzně	Plzeň	DBV-ITL, s.r.o.	www.dbv-itl.cz

1	2	3	4	5	6	7
2046	V	Jaroslav Komoň - vlečka Březnice	Březnice	Beroun	"STENO, v.o.s." - stavební a inženýrská činnost v kolejové dopravě	www.stenovos.cz
2047	V	Impregnace Soběslav s.r.o.	Soběslav	Tábor	Dopravní a inženýrské služby s.r.o.	www.k-buildingcb.cz
2048	V	Vlečka Jednota Borovany	Borovany	České Budějovice	BENTEX-Plast s.r.o.	www.bentex-plast.cz
2049	V	Jihočeské letiště České Budějovice	Boršov nad Vltavou	České Budějovice	Dr. ZENKL s.r.o.	www.drzenkl.cz
2050	V	JIP - papírny Větřní	Kájov	České Budějovice	JIP - Papírny Větřní, a. s.	www.jip.cz
2052	V	Kámen a písek Prachatice	Prachatice	České Budějovice	Kámen a písek, spol. s r.o.	www.kamen-ck.cz
2053	V	Kámen a písek Plešovice	Zlatá Koruna	České Budějovice	Kámen a písek, spol. s r.o.	www.kamen-ck.cz
2055	V	Kovohutě Příbram	Příbram	Beroun	Kovohutě Příbram nástupnická, a.s.	www.kovopb.cz
2057	V	Vlečka KX Líně	Chotěšov	Plzeň	Železniční projekčně-stavební kancelář s.r.o.	www.zpk-ds.cz
2058	V	LASSELSBERGER Borovany	Borovany	České Budějovice	Dr. ZENKL s.r.o.	www.drzenkl.cz
2059	V	LASSELSBERGER Chlumčany u Dobřan	Chlumčany u Dobřan	Plzeň	Dr. ZENKL s.r.o.	www.drzenkl.cz
2061	V	LB MINERALS Břasy	Chrást u Plzně - Radnice	Plzeň	Dr. ZENKL s.r.o.	www.drzenkl.cz
2062	V	LB MINERALS Meclov	Meclov	Plzeň	Dr. ZENKL s.r.o.	www.drzenkl.cz
2063	V	LB MINERALS Nová Ves nad Lužnicí	Nová Ves nad Lužnicí	Tábor	Dr. ZENKL s.r.o.	www.drzenkl.cz
2064	V	Lesní společnost Přimda, a. s.	Chodová Planá	Plzeň	Lesní společnost Přimda, s.r.o.	www.lasprimda.com
2067	V	Ligmet - Lazsko Milín	Milín	Beroun	Dr. ZENKL s.r.o.	www.drzenkl.cz
2068	V	MABA Prefa Veselí nad Lužnicí	Veselí nad Lužnicí	Tábor	"STENO, v.o.s." - stavební a inženýrská činnost v kolejové dopravě	www.stenovos.cz
2069	V	LAMIVEX Strakonice	Strakonice	České Budějovice	"STENO, v.o.s." - stavební a inženýrská činnost v kolejové dopravě	www.stenovos.cz
2070	V	Masokombinát Písek	Písek město	Tábor	Dr. ZENKL s.r.o.	www.drzenkl.cz
2071	V	JEDNOTA Týn nad Vltavou II	Týn nad Vltavou	České Budějovice	Dr. ZENKL s.r.o.	www.drzenkl.cz
2077	V	OKV Strakonice	Strakonice	České Budějovice	ČD Cargo, a.s.	www.cdcargo.cz
2079	V	OVERLACK, spol. s r.o.	Plzeň-Koterov	Plzeň	PKP CARGO INTERNATIONAL a.s.	www.pkpcargointernational.com
2080	V	Palstav s.r.o. Č. Budějovice	České Budějovice	České Budějovice	PALSTAV, s.r.o.	www.palstav.cz
2081	V	Teplárna Loučovice	Loučovice - Lipno nad Vltavou	České Budějovice	DBV-ITL, s.r.o.	www.dbv-itl.cz
2084	V	pivovar Platan Protivín	Protivín	České Budějovice	Dr. ZENKL s.r.o.	www.drzenkl.cz
2086	V	Polari - PHM, Písek město	Písek město	Tábor	Dr. ZENKL s.r.o.	www.drzenkl.cz
2087	V	Primagra, a.s. - vlečka Milín	Milín	Beroun	Primagra, a.s.	www.lovochemie.cz
2089	V	PROPERTY Plzeň	Plzeň hl.n.	Plzeň	Dr. ZENKL s.r.o.	www.drzenkl.cz
2090	V	Energo Příbram, s.r.o.	Příbram	Beroun	ReViRail s.r.o.	www.revirail.cz
2091	V	QUEEN SERVICE	Volyně - Čkyně	České Budějovice	"STENO, v.o.s." - stavební a inženýrská činnost v kolejové dopravě	www.stenovos.cz
2092	V	R. A. B. Třeboň	Třeboň	Tábor	Dopravní a inženýrské služby s.r.o.	www.k-buildingcb.cz
2093	V	Vlečka ROSSO STEEL, Mirošov	Mirošov - Příkosice	Plzeň	ROSSO STEEL, a.s.	www.rosso.cz

1	2	3	4	5	6	7
2094	V	Rybářství Třeboň Hld. A.s. - provoz Hluboká nad Vltavou	Hluboká nad Vltavou	České Budějovice	"STENO, v.o.s." - stavební a inženýrská činnost v kolejové dopravě	www.stenovos.cz
2096	V	Schiedel Zliv	Zliv	České Budějovice	Dopravní a inženýrské služby s.r.o.	www.k-buildingcb.cz
2097	V	Silo Borek u Zbiroha	Zbiroh	Plzeň	Ing. Jan DUDÁČEK	jandudacek@seznam.cz
2098	V	Vlečka - Planá nad Lužnicí	Planá nad Lužnicí	Tábor	ČD Cargo, a.s.	www.cdcargo.cz
2099	V	Skanska DS - vlečka montážní základna Křemže	Křemže	České Budějovice	Skanska a.s.	www.skanska.cz
2101	V	Skladový areál MR Pačejov	Pačejov	České Budějovice	Česká republika - Správa státních hmotných rezerv	www.spravazeleznic.cz
2102	V	SH-EKO - Ražice	Ražice	České Budějovice	"STENO, v.o.s." - stavební a inženýrská činnost v kolejové dopravě	www.stenovos.cz
2104	V	METALURGIE České Budějovice	České Budějovice	České Budějovice	Dr. ZENKL s.r.o.	www.drzenkl.cz
2105	V	Sloupárna Majdalena	Majdalena	Tábor	SLOUPÁRNA Majdalena s.r.o.	www.slouparna.cz
2106	V	SOKV České Budějovice	České Budějovice	České Budějovice	ČD Cargo, a.s.	www.cdcargo.cz
2107	V	Jihozápadní dřevařská - Sušice	Sušice	Plzeň	Dr. ZENKL s.r.o.	www.drzenkl.cz
2109	V	Dřevosklad Nová Pec	Nová Pec	České Budějovice	CityRail, a.s.	www.cityrail.cz
2110	V	FS terminal logistic	Suchdol nad Lužnicí	Tábor	DBV-ITL, s.r.o.	www.dbv-itl.cz
2111	V	Stora Enso Wood Products Planá s.r.o.	Planá u Mariánských Lázní	Plzeň	DBV-ITL, s.r.o.	www.dbv-itl.cz
2112	V	ZZN Pelhřimov - Čekanice	Čekanice	Tábor	Dr. ZENKL s.r.o.	www.drzenkl.cz
2116	V	Teplárna České Budějovice - hlavní závod	České Budějovice	České Budějovice	Dopravní a inženýrské služby s.r.o.	www.k-buildingcb.cz
2117	V	Teplárna Písek	Písek	Tábor	"STENO, v.o.s." - stavební a inženýrská činnost v kolejové dopravě	www.stenovos.cz
2118	V	Vlečka Teplárna Strakonice	Strakonice	České Budějovice	EDOP s.r.o.	v.kamba@tiscali.cz
2119	V	FORESTINA	Horažďovice	Plzeň	"STENO, v.o.s." - stavební a inženýrská činnost v kolejové dopravě	www.stenovos.cz
2120	V	TOMEGAS Branice	Branice	Tábor	"STENO, v.o.s." - stavební a inženýrská činnost v kolejové dopravě	www.stenovos.cz
2121	V	Vlečka TSR Plzeň	Plzeň	Plzeň	"STENO, v.o.s." - stavební a inženýrská činnost v kolejové dopravě	www.stenovos.cz
2122	V	TSS Starý Plzenec	Starý Plzenec	Plzeň	Traťová strojní společnost, a.s.	www.tssas.cz
2124	V	Vladimír Beneš - Temelín	Temelín	České Budějovice	SLEZSKOMORAVSKÁ DRÁHA a.s.	www.slezskomoravskad raha.cz
2125	V	Vlečka Bělčice	Bělčice	Tábor	"STENO, v.o.s." - stavební a inženýrská činnost v kolejové dopravě	www.stenovos.cz
2126	V	Vlečka S & H	Rokycany	Plzeň	DBV-ITL, s.r.o.	www.dbv-itl.cz
2129	V	Vlečka Fronk	Domažlice	Plzeň	JFSPED, s.r.o.	www.jfsped.cz
2131	V	SUBLIMA CZ, s.r.o.	Březnice	Beroun	"STENO, v.o.s." - stavební a inženýrská činnost v kolejové dopravě	www.stenovos.cz
2132	V	Vlečka SUDA	Plzeň - Křimice	Plzeň	Václav Suda	www.kovosrot-suda.cz

1	2	3	4	5	6	7
2133	V	Vlečka ŠKODA ELECTRIC	Plzeň hl.n.	Plzeň	TrainPro s.r.o.	jan.chudina@trainpro.cz
2134	V	Vlečka ŠKODA hlavní závod	Plzeň-Jižní předměstí	Plzeň	PKP CARGO INTERNATIONAL a.s.	www.pkpcargointernational.com
2135	V	Vlečka Včelná	Včelná	České Budějovice	"STENO, v.o.s." - stavební a inženýrská činnost v kolejové dopravě	www.stenovos.cz
2136	V	Vlečka ZUD a.s., Křimich Tlučná	Nýřany	Plzeň	STEEL PROFIL s.r.o.	www.steelprofil.cz
2138	V	Vojenská vlečka č. 5 - Bechyně-Dolina	Malšice - Sudoměřice u Bechyně	Tábor	Armádní Servisní, příspěvková organizace	www.as-po.cz
2140	V	Wienerberger - Záboří u Čičenic	Záboří u Čičenic	České Budějovice	"STENO, v.o.s." - stavební a inženýrská činnost v kolejové dopravě	www.stenovos.cz
2141	V	Prime Timber Solutions	Nové Hrady	České Budějovice	DBV-ITL, s.r.o.	www.dbv-itl.cz
2142	V	Wotan Forest, a.s., vlečka Velký Ratmírov	Velký Ratmírov	Tábor	Lovochemie, a.s.	www.lovochemie.cz
2143	V	Zeelandia spol. s r.o.	Malšice	Tábor	JIPOK, s.r.o.	jipok@volny.cz
2144	V	ZEKO Protivín	Protivín	České Budějovice	DBV-ITL, s.r.o.	www.dbv-itl.cz
2145	V	Zemědělské služby Dynín	Dynín	České Budějovice	Dopravní a inženýrské služby s.r.o.	www.k-buildingcb.cz
2146	V	ZETEN Blovice	Blovice	Plzeň	ZETEN spol. s r.o.	www.zetenblovice.cz
2147	V	ZETEN Nepomuk	Nepomuk	Plzeň	ZETEN spol. s r.o.	www.zetenblovice.cz
2149	V	Vlečka ZNZ, sklad Stod	Stod	Plzeň	ZNZ Přeštice, a.s.	www.znz.cz
2150	V	Vlečka ZVVZ	Milevsko	Tábor	"STENO, v.o.s." - stavební a inženýrská činnost v kolejové dopravě	www.stenovos.cz
2152	V	ZZN Pelhřimov-vlečka Omlenice	Omlenice	České Budějovice	Dr. ZENKL s.r.o.	www.drzenkl.cz
2153	V	ZZN Pelhřimov - VNS Záhoří	Záhoří	Tábor	Dr. ZENKL s.r.o.	www.drzenkl.cz
2154	V	Vlečka ZZN Strakonice - Silo Blatná	Blatná	Tábor	EDOP s.r.o.	v.kamba@tiscali.cz
2155	V	Vlečka ZZN Strakonice - středisko Vodňany	Vodňany	České Budějovice	EDOP s.r.o.	v.kamba@tiscali.cz
2156	V	ZZV Strunkovice nad Blanicí	Strunkovice nad Blanicí	České Budějovice	Zemědělské zásobování a výkup Prachatice,a.s.	j.kankova@zsvpt.cz
2157	V	Železářny Hrádek	Rokycany	Plzeň	FERROMET a.s.	www.ferromet.cz
2158	V	Vlečka Vagonka České Velenice	České Velenice	České Budějovice	Raeder & Falge s.r.o.	www.raeder-falge.cz
2159	V	ŽPSV a.s. závod Nové Hrady	Nové Hrady	České Budějovice	Pirell s.r.o.	www.pirell.cz
2193	V	CARTHAMUS a.s., vlečka Domoradice	Zlatá Koruna - Český Krumlov	České Budějovice	DBV-ITL, s.r.o.	www.dbv-itl.cz
2225	V	Kamenolom Černětice	Volyně - Čkyně	České Budějovice	ERB invest s.r.o.	www.rpmservice.cz
2244	V	Vlečka Stavební výroba Dolní Žandov	Dolní Žandov	Plzeň	DOSTA s.r.o.	www.dosta.cz
2245	V	ZDP Lázně Kynžvart	Lázně Kynžvart	Plzeň	DOSTA s.r.o.	www.dosta.cz
2246	V	EUTIT s.r.o. Stará Voda	Lázně Kynžvart	Plzeň	EUTIT s.r.o.	www.eutit.cz
2248	V	Lesy České republiky s.p., vlečka Kladská I	Lázně Kynžvart	Plzeň	DBV-ITL, s.r.o.	www.dbv-itl.cz

1	2	3	4	5	6	7
2249	V	ZDP Mariánské Lázně	Mariánské Lázně	Plzeň	DOSTA s.r.o.	www.dosta.cz
2253	V	Pfeifer Holz Trhanov	Trhanov	Plzeň	DOSTA s.r.o.	www.dosta.cz
2254	V	MOVO Plzeň	Plzeň	Plzeň	ŠKODA TRANSPORTATION a.s.	www.skoda.cz
2255	V	Mondi Bupak - provoz Rožnov	České Budějovice	České Budějovice	Mondi Bupak s.r.o.	www.mondigroup.com
2256	V	Radek Brožovský Chotoviny	Chotoviny	Tábor	Drahoslav Mráček	602 501 172
2257	V	Vlečka Smyslov	Chýnov - Tábor	Tábor	"STENO, v.o.s." - stavební a inženýrská činnost v kolejové dopravě	www.stenovos.cz
2259	V	Vlečka AGRONA Hostomice	Hostomice pod Brdy	Beroun	Ing. Jan DUDÁČEK	jandudacek@seznam.cz
2260	V	LB MINERALS Všeradice	Všeradice	Beroun	Dr. ZENKL s.r.o.	www.drzenkl.cz
2261	V	Agropodnik a.s. - sklad Hostomice pod Brdy	Hostomice pod Brdy	Beroun	"STENO, v.o.s." - stavební a inženýrská činnost v kolejové dopravě	www.stenovos.cz
2262	V	Teplárna Tábor	Tábor	Tábor	C-Energy Planá s.r.o.	www.c-energy.cz
2263	V	Lesní společnost Železná Ruda	Železná Ruda-Alžbětín	Plzeň	Lesní společnost Železná Ruda, a.s.	vaclav.rubas@centrum.cz
2264	V	JOANNES Kaplice	Kaplice	České Budějovice	Dr. ZENKL s.r.o.	www.drzenkl.cz
2265	V	ČD, a.s. - Plzeň, Myčka OV	Plzeň hl.n.	Plzeň	České dráhy, a.s.	www.ceskedrahy.cz
2266	V	VLEČKA - Výtopna Babín	Horažďovice předměstí	České Budějovice	RETROLOK s.r.o.	www.retlok.com
2267	V	ČD, a.s. - Tachov	Tachov	Plzeň	České dráhy, a.s.	www.ceskedrahy.cz
2268	V	ČD, a.s. - Bezručice	Bezručice	Plzeň	České dráhy, a.s.	www.ceskedrahy.cz
2269	V	ČD, a.s. - Bělá nad Radbuzou	Bělá nad Radbuzou	Plzeň	České dráhy, a.s.	www.ceskedrahy.cz
2270	V	ČD, a.s. - Domažlice	Domažlice	Plzeň	České dráhy, a.s.	www.ceskedrahy.cz
2271	V	ČD, a.s. - Nýřany	Nýřany	Plzeň	České dráhy, a.s.	www.ceskedrahy.cz
2272	V	ČD, a.s. - Klatovy	Klatovy	Plzeň	České dráhy, a.s.	www.ceskedrahy.cz
2273	V	ČD, a.s. - Lochovice	Lochovice	Beroun	České dráhy, a.s.	www.ceskedrahy.cz
2274	V	Vlečka Radouš 94	Neumětely	Beroun	Ing. Jan DUDÁČEK	jandudacek@seznam.cz
2275	V	ČD, a.s. - Mirošov	Mirošov	Plzeň	České dráhy, a.s.	www.ceskedrahy.cz
2276	V	Vlečka Remíza	Tábor	Tábor	Railway Capital a.s.	www.railwaycapital.cz
2277	V	ČD, a.s. - Netolice	Netolice	České Budějovice	České dráhy, a.s.	www.ceskedrahy.cz
2278	V	ČD, a.s. - Blatná	Blatná	Tábor	České dráhy, a.s.	www.ceskedrahy.cz
2279	V	ČD, a.s. - Protivín	Protivín	České Budějovice	České dráhy, a.s.	www.ceskedrahy.cz
2280	V	ČD, a.s. - Týn nad Vltavou	Týn nad Vltavou	České Budějovice	České dráhy, a.s.	www.ceskedrahy.cz
2281	V	Vlečka PP Volary	Volary	České Budějovice	Railway Capital a.s.	www.railwaycapital.cz
2282	V	ČD, a.s. - Veselí nad Lužnicí	Veselí nad Lužnicí	Tábor	České dráhy, a.s.	www.ceskedrahy.cz
2283	V	Plzeňská teplárenská, a.s.	Plzeň	Plzeň	Plzeňská teplárenská, a.s.	www.plzenskateplarenska.cz
2284	V	ČD, a.s. - Plzeň	Plzeň	Plzeň	České dráhy, a.s.	www.ceskedrahy.cz
2285	V	DELTA	Jindřichův Hradec	Tábor	CityRail, a.s.	www.cityrail.cz
2286	V	ČD, a.s. - Plzeň - POL	Plzeň	Plzeň	České dráhy, a.s.	www.ceskedrahy.cz
2287	V	ČD, a.s. - Tábor (celostátní dráha SŽ)	Tábor	Tábor	České dráhy, a.s.	www.ceskedrahy.cz
2287	V	ČD, a.s. - Tábor (vlečka SŽ)	Tábor	Tábor	České dráhy, a.s.	www.ceskedrahy.cz

1	2	3	4	5	6	7
2288	V	ČD, a.s. - České Budějovice	České Budějovice	České Budějovice	České dráhy, a.s.	www.ceskedrahy.cz
2289	V	ČD, a.s. - Klatovy (1)	Klatovy	Plzeň	České dráhy, a.s.	www.ceskedrahy.cz
2290	V	ČD, a.s. - Pňovany	Pňovany	Plzeň	České dráhy, a.s.	www.ceskedrahy.cz
2291	V	Vlečka KLAUS Timber	Plzeň	Plzeň	ČD Cargo, a.s.	www.cdcargo.cz
2904	V	Vlečka Klíma Prachatice	Prachatice	České Budějovice	Dopravní a inženýrské služby s.r.o.	www.k-buildingcb.cz
2905	V	Vlečka Tábor	Tábor	Tábor	Správa železnic, státní organizace	www.spravazeleznic.cz
3002	V	Vlečka Brik - Bečov u Mostu	Bečov u Mostu	Most	DBV-ITL, s.r.o.	www.dbv-itl.cz
3003	V	Euro-bit Bělá pod Bezdězem	Bělá pod Bezdězem	Liberec	"STENO, v.o.s." - stavební a inženýrská činnost v kolejové dopravě	www.stenovos.cz
3004	V	REALTORIA k.s., Bělá pod Bezdězem	Bakov nad Jizerou - Bělá pod Bezdězem	Liberec	"STENO, v.o.s." - stavební a inženýrská činnost v kolejové dopravě	www.stenovos.cz
3006	V	Doly Bílina - vlečka hlavního skladu	Bílina	Most	SD - Kolejová doprava, a.s.	www.sd-kd.cz
3007	V	Vnější vlečka "ČEZ, a.s. - Elektrárna Ledvice"	Bílina	Most	SD - Kolejová doprava, a.s.	www.sd-kd.cz
3008	V	Basalt základna Bílina	Bílina	Most	STRABAG Rail a.s.	www.strabagrail.cz
3009	V	Doly Bílina - vlečka skladu Ropných produktů	Bílina	Most	SD - Kolejová doprava, a.s.	www.sd-kd.cz
3011	V	Montážní základna Chabařovice	Krupka - Bohosudov	Ústí nad Labem	STRABAG Rail a.s.	www.strabagrail.cz
3017	V	AgroZZN, a.s. - vlečka Bohušovice nad Ohří	Bohušovice nad Ohří	Ústí nad Labem	Dr. ZENKL s.r.o.	www.drzenkl.cz
3019	V	DS SMITH	Boletice nad Labem	Děčín	CZ Logistics, s.r.o.	www.czlog.cz
3020	V	CHEMOTEX Děčín	Boletice nad Labem	Děčín	"STENO, v.o.s." - stavební a inženýrská činnost v kolejové dopravě	www.stenovos.cz
3021	V	DIAMO - Luhov	Brniště	Liberec	IDS - Inženýrské a dopravní stavby Olomouc a.s.	www.ids-olomouc.cz
3023	V	Předávací nádraží Březno u Chomutova	Březno u Chomutova	Most	SD - Kolejová doprava, a.s.	www.sd-kd.cz
3026	V	Elektroporcelán Louny - Březno	Louny předměstí - Březno u Postoloprť	Most	"STENO, v.o.s." - stavební a inženýrská činnost v kolejové dopravě	www.stenovos.cz
3027	V	KYSELKA PRAGA Břvany	Břvany	Most	Dr. ZENKL s.r.o.	www.drzenkl.cz
3028	V	Kongresové centrum ILF, vlečka Bystřany	Bystřany v Čechách	Ústí nad Labem	Dr. ZENKL s.r.o.	www.drzenkl.cz
3029	V	Vlečka SU-T Citice UTT	Citice	Karlovy Vary	SUAS Transportation Service s.r.o.	www.suas-transportation.cz
3031	V	AgroZZN, a.s. - vlečka Černovice u Chomutova	Černovice u Chomutova	Karlovy Vary	Dr. ZENKL s.r.o.	www.drzenkl.cz
3032	V	TRANSPEDIA Česká Kamenice	Česká Kamenice - Mlýny	Děčín	TrainPro s.r.o.	jan.chudina@trainpro.cz
3034	V	FESTA středisko Česká Lípa	Česká Lípa hl.n.	Liberec	"STENO, v.o.s." - stavební a inženýrská činnost v kolejové dopravě	www.stenovos.cz

1	2	3	4	5	6	7
3035	V	Marius Pedersen - Česká Lípa	Česká Lípa hl.n.	Liberec	"STENO, v.o.s." - stavební a inženýrská činnost v kolejové dopravě	www.stenovos.cz
3036	V	Vendys Česká Lípa - I.	Česká Lípa hl.n.	Liberec	"STENO, v.o.s." - stavební a inženýrská činnost v kolejové dopravě	www.stenovos.cz
3038	V	KERAMOST Obrnice	České Zlatníky	Most	DBV-ITL, s.r.o.	www.dbv-itl.cz
3039	V	Čížkovická cementárna, a.s.	Čížkovice	Ústí nad Labem	Lafarge Cement, a.s.	www.lafarge.cz
3045	V	Vlečka RYKO a.s. I., II. a III.	Děčín hl.n. západ	Děčín	IDS CARGO a.s.	www.ids-cargo.cz
3047	V	ALUMINIUM DĚČÍN	Děčín hl.n.	Děčín	AFC Servis DC a.s.	www.afcservisdc.cz
3048	V	KOVOŠROT GROUP CZ a.s. - vlečka Děčín	Děčín hl.n.	Děčín	PKP CARGO INTERNATIONAL a.s.	www.pkpcargointernational.com
3050	V	Vlečka přístav Loubí	Děčín východ	Děčín	Raeder & Falge s.r.o.	www.raeder-falge.cz
3051	V	TOS Varnsdorf	Dolní Podluží	Děčín	"STENO, v.o.s." - stavební a inženýrská činnost v kolejové dopravě	www.stenovos.cz
3053	V	Vlečka VITRABLOK Duchcov	Oldřichov u Duchcova	Ústí nad Labem	Raeder & Falge s.r.o.	www.raeder-falge.cz
3056	V	Vlečka Hájek	Hájek	Karlovy Vary	"STENO, v.o.s." - stavební a inženýrská činnost v kolejové dopravě	www.stenovos.cz
3058	V	Vlečka Hněvice	Hněvice	Ústí nad Labem	"STENO, v.o.s." - stavební a inženýrská činnost v kolejové dopravě	www.stenovos.cz
3059	V	ČEZ, A.S.-ELEKTRÁRNA MĚLNÍK	Hněvice, Dolní Beřkovice	Ústí nad Labem	SD – Kolejová doprava, a.s.	www.sd-kd.cz
3060	V	Mondi Štětí, a.s.	Hněvice, Štětí	Ústí nad Labem, Děčín	PKP CARGO INTERNATIONAL a.s.	www.pkpcargointernational.com
3062	V	LB IMMO Horní Bříza	Horní Bříza	Karlovy Vary	Dr. ZENKL s.r.o.	www.drzenkl.cz
3063	V	AROMA Židovice	Hrobce	Ústí nad Labem	DBV-ITL, s.r.o.	www.dbv-itl.cz
3067	V	PH KOVO-RECYCLING CHEB, s.r.o.	Cheb	Karlovy Vary	DOSTA s.r.o.	www.dosta.cz
3068	V	OKV Cheb	Cheb	Karlovy Vary	ČD Cargo, a.s.	www.cdcargo.cz
3073	V	Primagra, a.s. - vlečka Cheb	Cheb	Karlovy Vary	Primagra, a.s.	www.primagra.cz
3074	V	Vlečka Day - Dec s.r.o.	Chodov	Karlovy Vary	DOSTA s.r.o.	www.dosta.cz
3075	V	Vlečka - Montážní základna Chodov	Chodov	Karlovy Vary	Správa železnic, státní organizace	www.spravazeleznic.cz
3076	V	Ferona, a. s. vlečka Chomutov - Spořice	Chomutov	Karlovy Vary	Ferona, a.s.	www.ferona.cz
3077	V	KOVOŠROT GROUP CZ a.s. - vlečka Chomutov	Chomutov	Karlovy Vary	PKP CARGO INTERNATIONAL a.s.	www.pkpcargointernational.com
3085	V	12 006 Válcovny trub Chomutov	Chomutov	Karlovy Vary	TovarGo, s.r.o.	www.tovargo.cz
3086	V	Vlečka A.G. Service, Chotěšov pod Hazmburkem	Chotěšov pod Hazmburkem	Ústí nad Labem	Miloš Hojda-Business-service	www.agservice.cz
3087	V	ZZN Polabí, a.s. - vlečka Provodín	Jestřebí	Liberec	ZZN Polabí, a.s.	www.zznpolabi.cz
3088	V	Provodínské písky Provodín a.s.	Jestřebí	Liberec	Provodínské písky a.s.	www.pisky.cz
3094	V	Vlečka ČEZ, a.s.-elektrárna Pruněřov	Kadaň - Pruněřov	Karlovy Vary	SD – Kolejová doprava, a.s.	www.sd-kd.cz

1	2	3	4	5	6	7
3100	V	Vlečka a.s. ZZ Plzeň, provoz Kaznějov II	Kaznějov	Karlovy Vary	Dr. ZENKL s.r.o.	www.drzenkl.cz
3101	V	LB MINERALS Kaznějov	Kaznějov	Karlovy Vary	Dr. ZENKL s.r.o.	www.drzenkl.cz
3107	V	AgroZZN, a.s. - vlečka Dobroměřice	Lenešice	Most	Dr. ZENKL s.r.o.	www.drzenkl.cz
3115	V	TSS-LOUNY	Louny	Most	Traťová strojní společnost, a.s.	www.tssas.cz
3116	V	AgroZZN, a.s. - vlečka Louny	Louny-město	Most	Dr. ZENKL s.r.o.	www.drzenkl.cz
3117	V	Vlečka Rail Cargo Operator - CSKD s.r.o. Lovosice	Lovosice	Ústí nad Labem	TRANS-SPED-CONSULT s.r.o.	trans.sped.consult@iol.cz
3119	V	TSS Lovosice	Lovosice	Ústí nad Labem	Traťová strojní společnost, a.s.	www.tssas.cz
3120	V	Vlečka Logistické centrum LOVOSICE	Lovosice	Ústí nad Labem	ČD Cargo, a.s.	www.cdcargo.cz
3124	V	Lovochemie a.s. - závodová vlečka	Lovosice	ústí nad Labem	Lovochemie, a.s.	www.lovochemie.cz
3125	V	Vlečka Commexim Group Sulejovice	Lovosice - Čížkovice	Ústí nad Labem	AŽD Praha s.r.o.	www.azd.cz
3132	V	ZZN Polabí, a.s. - vlečka Mimoň	Mimoň - Mimoň Staré nádraží	Liberec	ZZN Polabí, a.s.	www.zznpolabi.cz
3136	V	ZZN Semily, a.s., závod Mimoň	Mimoň - Mimoň Staré nádraží	Liberec	"STENO, v.o.s." - stavební a inženýrská činnost v kolejové dopravě	www.stenovos.cz
3141	V	Vlečka UNIPETROL RPA, s.r.o. Litvínov	Most nové nádraží	Most	ORLEN Unipetrol Doprava s.r.o.	www.orlenunipetroldoprava.cz
3142	V	OKV Most	Most nové nádraží	Most	ČD Cargo, a.s.	www.cdcargo.cz
3143	V	Primagra, a.s. - vlečka Nebanice	Nebanice	Karlovy Vary	Primagra, a.s.	www.lovochemie.cz
3145	V	Vlečka SU-T Vřesová	Nové Sedlo u Lokte	Karlovy Vary	SUAS Transportation Service s.r.o.	www.suas-transportation.cz
3150	V	Vlečka HET Ohníč	Ohníč	Most	Raeder & Falge s.r.o.	www.raeder-falge.cz
3151	V	ATMOS Bělá pod Bezdězem, vlečka Okna	Okna	Liberec	DBV-ITL, s.r.o.	www.dbv-itl.cz
3152	V	Skladový areál MR Okna	Okna	Liberec	Česká republika - Správa státních hmotných rezerv	www.spravazeleznic.cz
3157	V	Vlečka KRONOSPAN	Osek	Most	SILVA CZ, s.r.o.	www.kronospan.cz
3160	V	Manipulační sklad Ostrov nad Ohří - KALESPO	Ostrov nad Ohří	Karlovy Vary	DOSTA s.r.o.	www.dosta.cz
3161	V	Vlečka PAPOS v.o.s.	Ostrov nad Ohří	Karlovy Vary	PAPOS Estate, s.r.o.	www.papos.cz
3162	V	EPC	Počerady	Most	Coal Services a.s.	www.7energy.com
3163	V	Hrabák	Počerady	Most	Coal Services a.s.	www.7energy.com
3164	V	Vojenská vlečka č. 1 - Podbořany	Podbořany	Karlovy Vary	Armádní Servisní, příspěvková organizace	www.as-po.cz
3165	V	Vlečka LASSELSBERGER Podbořany	Podbořany	Karlovy Vary	Dr. ZENKL s.r.o.	www.drzenkl.cz
3166	V	AgroZZN, a.s. - vlečka Podbořany	Podbořany	Karlovy Vary	Dr. ZENKL s.r.o.	www.drzenkl.cz

1	2	3	4	5	6	7
3167	V	Vlečka Montážní základna Polepy	Polepy	Děčín	N+N - Konstrukce a dopravní stavby Litoměřice, s.r.o.	www.nanlitomerice.cz
3168	V	Vlečka KB - BLOK	Postoloprty	Most	KB - BLOK systém, s.r.o.	www.kb-blok.cz
3170	V	MEVA divize Bezděkov, Roudnice nad Labem	Roudnice nad Labem	Ústí nad Labem	"STENO, v.o.s." - stavební a inženýrská činnost v kolejové dopravě	www.stenovos.cz
3171	V	Vlečka Vitana - Roudnice nad Labem	Roudnice nad Labem	Ústí nad Labem	Jan Nešněra - LOKO	jan.nesnera.loko@seznam.cz
3174	V	Vlečka IDS CARGO a.s. Řehlovice	Řehlovice	Ústí nad Labem	IDS CARGO a.s.	www.ids-cargo.cz
3175	V	Vlečka Řetenice	Řetenice	Ústí nad Labem	AGC Flat Glass Czech a.s., člen AGC Group	www.agc-glass.eu
3176	V	Vlečka Teplická strojárna	Řetenice	Ústí nad Labem	Teplická strojárna s.r.o.	www.texas.cz
3180	V	Sedlecký kaolin a.s., vlečka Sadov	Sadov	Karlovy Vary	Dr. ZENKL s.r.o.	www.drzenkl.cz
3183	V	Chemie Sokolov vl. vl.	Sokolov	Karlovy Vary	PKP CARGO INTERNATIONAL a.s.	www.pkpcargointernational.com
3184	V	SUEZ – Vlečka Srní u České Lípy	Srní u České Lípy	Liberec	"STENO, v.o.s." - stavební a inženýrská činnost v kolejové dopravě	www.stenovos.cz
3189	V	Doly Bílina - úpravna uhlí Ledvice	Světec	Most	SD – Kolejová doprava, a.s.	www.sd-kd.cz
3190	V	Vlečka - areál Hostomice	Světec	Most	"STENO, v.o.s." - stavební a inženýrská činnost v kolejové dopravě	www.stenovos.cz
3192	V	Vlečka Tonaso a.s.	Ústí nad Labem hl.n. - Povrly	Ústí nad Labem	ESON s.r.o.	www.esonul.cz
3198	V	Vlečka Sedlecký kaolin - Osmóza	Chodov - Božičany	Karlovy Vary	Dr. ZENKL s.r.o.	www.drzenkl.cz
3203	V	Vlečka PTM Most	Most nové nádraží	Most	N+N - Konstrukce a dopravní stavby Litoměřice, s.r.o.	www.nanlitomerice.cz
3204	V	Vlečka METALIS Nejdek	Nejdek - Nové Hamry	Karlovy Vary	DOSTA s.r.o.	www.dosta.cz
3205	V	Vlečka Nejdecké česárny vlny a.s.	Nová Role - Nejdek	Karlovy Vary	DOSTA s.r.o.	ww.dosta.cz
3207	V	LB MINERALS Skalná	Skalná - Velký Luh	Karlovy Vary	Dr. ZENKL s.r.o.	www.drzenkl.cz
3208	V	Kamenolom Šluknov	Šluknov - Velký Šenov	Děčín	Ing. Miloslav Šmíd	vlecky.smid@seznam.cz
3211	V	LB MINERALS Vonšov	Vonšov	Karlovy Vary	Dr. ZENKL s.r.o.	www.drzenkl.cz
3213	V	Brispol	Kadaň předměstí - Želina	Karlovy Vary	PDV RAILWAY a.s.	www.rcas.cz
3215	V	Vlečka Štědrá	Štědrá	Karlovy Vary	MBM rail s.r.o.	www.mbmr.cz
3218	V	Vlečka O-I Manufacturing ČR - Dubí	Teplice lesní brána	Ústí nad Labem, Děčín	PKP CARGO INTERNATIONAL a.s.	www.pkpcargointernational.com
3228	V	KOVODEMONT CZECH, a.s. - vlečka Třebušice	Třebušice	Most	Provozování dráhy, kolejové stavby a servis Tomáš Bryda	tomas.bryda@gmail.com
3229	V	Komořany	Třebušice, Most nové nádraží	Most	Coal Services a.s.	www.7energy.com
3230	V	Teplárna Komořany	Třebušice	Most	DOSTA s.r.o.	www.dosta.cz
3231	V	Kamenina Třemošná	Třemošná u Plzně	Karlovy Vary	Dr. ZENKL s.r.o.	www.drzenkl.cz
3232	V	Vlečka ŠKODA JS	Třemošná u Plzně	Karlovy Vary	ŠKODA JS a.s.	www.skoda-js.cz
3233	V	ŽÁROHMOTY-PLATINKA Třemošná	Třemošná u Plzně	Karlovy Vary	Dr. ZENKL s.r.o.	www.drzenkl.cz

1	2	3	4	5	6	7
3234	V	Vlečka Třemošná	Třemošná u Plzně	Karlovy Vary	"STENO, v.o.s." - stavební a inženýrská činnost v kolejové dopravě	www.stenovos.cz
3235	V	Vlečka LYBAR, a.s. Velvěty	Úpořiny	Ústí nad Labem	Enaspol a.s.	www.enaspol.cz
3237	V	DeltaChem Ústí nad Labem	Ústí nad Labem hl.n. sever	Ústí nad Labem	"STENO, v.o.s." - stavební a inženýrská činnost v kolejové dopravě	www.stenovos.cz
3240	V	Přístav Vaňov	Ústí nad Labem hl.n. jih	Ústí nad Labem	Dr. ZENKL s.r.o.	www.drzenkl.cz
3241	V	Vlečka Závod Střekov - Klihovna	Ústí nad Labem-Střekov	Děčín	IDS CARGO a.s.	www.ids-cargo.cz
3242	V	Vlečka Závod Střekov - Dolní větev 2	Ústí nad Labem-Střekov	Děčín	IDS CARGO a.s.	www.ids-cargo.cz
3243	V	Vlečka Závod Střekov - Horní větev 1	Ústí nad Labem-Střekov	Děčín	IDS CARGO a.s.	www.ids-cargo.cz
3244	V	Vlečka Olšinky	Ústí nad Labem-Střekov - Velké Březno	Ústí nad Labem	IDS CARGO a.s.	www.ids-cargo.cz
3245	V	Spolek pro chemickou a hutní výrobu a.s., Ústí nad Labem	Ústí nad Labem hl.n. západ	Ústí nad Labem	Spolek pro chemickou a hutní výrobu, akciová společnost	www.spolchemie.cz
3246	V	Vlečka Chemopharma a.s. Ústí nad Labem	Ústí nad Labem západ	Ústí nad Labem	PKP CARGO INTERNATIONAL a.s.	www.pkpcargointernational.com
3248	V	Vlečka Lom Mariánská Skála	Ústí nad Labem hl.n. sever	Ústí nad Labem	Pirell s.r.o.	www.pirell.cz
3249	V	Vlečka ACTIVIUS Ústí nad Labem	Ústí nad Labem hl.n. sever	Ústí nad Labem	Ing. Miloslav Šmíd	vlecky.smid@seznam.cz
3251	V	Vlečka GRANETTE a.s., Krásné Březno	Ústí nad Labem hl.n. sever	Ústí nad Labem	PKP CARGO INTERNATIONAL a.s.	www.pkpcargointernational.com
3252	V	Vlečka Ústecké dopravní stavby	Ústí nad Labem západ	Ústí nad Labem	Antonín Šremer s.r.o.	antonin.sremer@centrum.cz
3253	V	Vlečka IZOBAL Ústí nad Labem západ	Ústí nad Labem západ	Ústí nad Labem	Provozování dráhy, kolejové stavby a servis Tomáš Brýda	tomas.bryda@gmail.com
3254	V	OKV Ústí nad Labem	Ústí nad Labem hl.n. západ	Ústí nad Labem	ČD Cargo, a.s.	www.cdcargo.cz
3255	V	Vlečka PKÚ Trmice	Ústí nad Labem hl.n. západ	Ústí nad Labem	SD – Kolejová doprava, a.s.	www.sd-kd.cz
3257	V	Vlečka Teplárna Ústí nad Labem	Ústí nad Labem hl.n. západ	Ústí nad Labem	SD – Kolejová doprava, a.s.	www.sd-kd.cz
3258	V	Vlečka - přístav Ústí nad Labem	Ústí nad Labem hl.n. sever	Ústí nad Labem	České přístavy, a.s.	www.ceskepristavy.cz
3259	V	VELVETA a.s. Varnsdorf	Varnsdorf	Děčín	"STENO, v.o.s." - stavební a inženýrská činnost v kolejové dopravě	www.stenovos.cz
3260	V	NOPROSU II	Varnsdorf	Děčín	TrainPro s.r.o.	jan.chudina@trainpro.cz

1	2	3	4	5	6	7
3261	V	NOPROSU	Varnsdorf	Děčín	"STENO, v.o.s." - stavební a inženýrská činnost v kolejové dopravě	www.stenovos.cz
3264	V	Místní dráha Velké Březno - Ústěk	Velké Březno	Děčín	MBM rail s.r.o.	www.mbmr.cz
3267	V	Vlečka Mattoni - Kyselka	Vojkovice nad Ohří	Karlovy Vary	Rail system s.r.o.	www.railsystem.cz
3268	V	Primagra, a.s. - vlečka Vojtanov	Vojtanov	Karlovy Vary	Primagra, a.s.	www.lovochemie.cz
3270	V	AgroZZN, a.s. - vlečka Vrbno nad Lesy	Vrbno nad Lesy	Most	Dr. ZENKL s.r.o.	www.drzenkl.cz
3271	V	AgroZZN, a.s. - vlečka Žabokliky	Žabokliky	Karlovy Vary	Dr. ZENKL s.r.o.	www.drzenkl.cz
3276	V	AgroZZN, a.s. - vlečka Žatec	Žatec	Most	Dr. ZENKL s.r.o.	www.drzenkl.cz
3277	V	Vlečka PREFA ŽATEC	Žatec západ - Velichov	Most	Raeder & Falge s.r.o.	www.raeder-falge.cz
3278	V	CHMELÁŘSTVÍ Žatec	Žatec západ	Most	"STENO, v.o.s." - stavební a inženýrská činnost v kolejové dopravě	www.stenovos.cz
3279	V	Vlečka Karel Musil	Žatec západ	Most	"STENO, v.o.s." - stavební a inženýrská činnost v kolejové dopravě	www.stenovos.cz
3280	V	Labena Žatec	Žatec západ	Most	"STENO, v.o.s." - stavební a inženýrská činnost v kolejové dopravě	www.stenovos.cz
3286	V	Sedlecký kaolin a.s., vlečka Božičany	Božičany z.	Karlovy Vary	Dr. ZENKL s.r.o.	www.drzenkl.cz
3288	V	Vlečka RSM Děčín východ d.n.	Děčín východ	Děčín	České dráhy, a.s.	www.ceskedrahy.cz
3289	V	JKV Depo s.r.o. - Lovosice	Lovosice	Ústí nad Labem	"STENO, v.o.s." - stavební a inženýrská činnost v kolejové dopravě	www.stenovos.cz
3291	V	Vlečka - Depo Teplice	Teplice v Čechách	Ústí nad Labem	Správa Ústecké dráhy s.r.o.	www.usteckadraha.cz
3292	V	ČD, a.s. - Cheb	Cheb	Karlovy Vary	České dráhy, a.s.	www.ceskedrahy.cz
3294	V	Vlečka LOKO-MOTIV	Křimov	Karlovy Vary	MBM rail s.r.o.	www.mbmr.cz
3295	V	Vlečka SŽDC Bohosudov - Chabařovice st.n.	Bohosudov	Ústí nad Labem	Správa železnic, státní organizace	www.spravazeleznic.cz
3296	V	ČD-DUSS Terminál, a.s.	Lovosice	Ústí nad Labem	ČD-DUSS Terminál, a.s.	cabalka.jaromir@cdd-terminal.cz
3297	V	Vlečka Duchcov	Oldřichov u Duchcova	Ústí nad Labem	Správa železnic, státní organizace	www.spravazeleznic.cz
3298	V	IDS CARGO a.s. Děčín východ	Děčín východ	Děčín	IDS CARGO a.s.	www.ids-cargo.cz
3299	V	ČD, a.s. - Louny	Louny	Most	České dráhy, a.s.	www.ceskedrahy.cz
3301	V	Vlečka Lovosice	Lovosice	Ústí nad Labem	PKP CARGO INTERNATIONAL a.s.	www.pkpcargointernational.com
3302	V	Vlečka TSR Dalovice	Dalovice	Karlovy Vary	"STENO, v.o.s." - stavební a inženýrská činnost v kolejové dopravě	www.stenovos.cz
3303	V	NTM Chomutov	Chomutov	Karlovy Vary	České dráhy, a.s.	www.ceskedrahy.cz
3304	V	ČD, a.s. - Ústí nad Labem	Ústí nad Labem hl.n.	Ústí nad Labem	České dráhy, a.s.	www.ceskedrahy.cz
3305	V	ČD, a.s. - Česká Lípa	Česká Lípa hl.n.	Liberec	České dráhy, a.s.	www.ceskedrahy.cz
3306	V	ČD, a.s. - Rumburk	Rumburk	Děčín	České dráhy, a.s.	www.ceskedrahy.cz
3307	V	Vlečka SŽDC průmyslová kolej - Ústí nad Labem západ	Ústí nad Labem západ	Ústí nad Labem	Správa železnic, státní organizace	www.spravazeleznic.cz

1	2	3	4	5	6	7
3308	V	ČD, a.s. - Děčín z. n. kolej č. 208	Děčín hl.n.	Děčín	České dráhy, a.s.	www.ceskedrahy.cz
3309	V	ČD, a.s. - Most	Most	Most	České dráhy, a.s.	www.ceskedrahy.cz
3312	V	Vlečka Oldřichov u Duchcova	Oldřichov u Duchcova	Ústí nad Labem	Správa železnic, státní organizace	www.spravazeleznic.cz
4104	V	EŽ Praha a.s. - Česká Třebová	Česká Třebová	Česká Třebová	Elektrizace železnic Praha a.s.	www.elzel.cz
4105	V	Vlečka Korado a.s.	Česká Třebová	Česká Třebová	Doc.Ing. Rudolf Kampf, CSc.	rudolf.kampf@post.cz
4108	V	EUROVIA Kamenolomy, a.s. - lom Chornice	Dzbel - Chornice	Česká Třebová	SLEZSKOMORAVSKÁ DRÁHA a.s.	www.slezskomoravskad raha.cz
4110	V	Vlečka ČEZ Distribuce RO Krasíkov	Krasíkov	Česká Třebová	PRODRA s.r.o.	www.prodra.cz
4111	V	Vlečka Agrochem a.s. Lanškroun (ZZN)	Lanškroun	Česká Třebová	Agrochem a.s. Lanškroun	www.agrochem.cz
4112	V	Vlečka Agrochem a.s. Lanškroun	Lanškroun	Česká Třebová	Agrochem a.s. Lanškroun	www.agrochem.cz
4115	V	SV metal s.r.o. Letohrad	Letohrad	Česká Třebová	PRODRA s.r.o.	www.prodra.cz
4117	V	Vlečka Lom Litice n. O.	Litice nad Orlicí	Česká Třebová	DBV-ITL, s.r.o.	www.dbv-itl.cz
4118	V	Cerea, a.s. - vlečka Městečko Trnávka	Městečko Trnávka	Česká Třebová	DBV-ITL, s.r.o.	www.dbv-itl.cz
4120	V	Firma FAULHAMMER s.r.o., středisko Polička	Polička	Česká Třebová	Firma FAULHAMMER s.r.o.	www.faulhammer.cz
4121	V	Petr Švanda	Polička	Česká Třebová	ČD Cargo, a.s.	www.cdcargo.cz
4124	V	Qanto Svitavy	Svitavy	Česká Třebová	DBV-ITL, s.r.o.	www.dbv-itl.cz
4125	V	Vlečka ZZN Svitavy a.s.	Svitavy	Česká Třebová	DBV-ITL, s.r.o.	www.dbv-itl.cz
4128	V	Vojenská vlečka č. 23 - Ústí nad Orlicí	Ústí nad Orlicí	Česká Třebová	Armádní Servisní, příspěvková organizace	www.as-po.cz
4130	V	Vlečka Agro Žamberk	Žamberk	Česká Třebová	PRODRA s.r.o.	www.prodra.cz
4131	V	Vlečka RSM Polička	Polička	Česká Třebová	České dráhy, a.s.	www.ceskedrahy.cz
4132	V	METRANS Česká Třebová	Česká Třebová	Česká Třebová	METRANS, a.s.	www.metrans.eu
4133	V	RSM Hradec Králové, ŽST Česká Třebová	Česká Třebová	Česká Třebová	České dráhy, a.s.	www.ceskedrahy.cz
4134	V	RSM Hradec Králové, ŽST Třebovice v Čechách	Třebovice v Čechách	Česká Třebová	České dráhy, a.s.	www.ceskedrahy.cz
4135	V	RSM Hradec Králové, ŽST Svitavy	Svitavy	Česká Třebová	České dráhy, a.s.	www.ceskedrahy.cz
4136	V	ČD, a.s. - Letohrad	Letohrad	Česká Třebová	České dráhy, a.s.	www.ceskedrahy.cz
4137	V	ČD, a.s. - Česká Třebová	Česká Třebová	Česká Třebová	České dráhy, a.s.	www.ceskedrahy.cz
4201	V	TSS Borohrádek	Borohrádek	Hradec Králové	TSS Cargo a.s.	www.tsscargo.cz
4202	V	Vlečka Serafin Campestrini Borohrádek	Borohrádek	Hradec Králové	PRODRA s.r.o.	www.prodra.cz
4203	V	AD MACH s.r.o., vlečka Borohrádek	Borohrádek	Hradec Králové	DBV-ITL, s.r.o.	www.dbv-itl.cz
4204	V	Wotan Forest, a.s. - vlečka Borohrádek	Borohrádek	Hradec Králové	Lovochemie, a.s.	www.lovochemie.cz
4206	V	Vlečka Saint-Gobain Častolovice	Častolovice	Hradec Králové	PRODRA s.r.o.	www.prodra.cz

1	2	3	4	5	6	7
4208	V	Vojenská vlečka č. 29 - Čermná nad Orlicí	Čermná nad Orlicí	Česká Třebová	Armádní Servisní, příspěvková organizace	www.as-po.cz
4209	V	Vlečka AGROPODNIK ORLICE a.s. Doudleby nad Orlicí	Doudleby nad Orlicí	Hradec Králové	PRODRA s.r.o.	www.prodra.cz
4211	V	ČEZ, a.s. - teplárna Dvůr Králové nad Labem	Dvůr Králové nad Labem	Liberec	SD – Kolejová doprava, a.s.	www.sd-kd.cz
4212	V	Vlečka Cerekvice	Hněvčeves	Hradec Králové	"STENO, v.o.s." - stavební a inženýrská činnost v kolejové dopravě	www.stenovos.cz
4214	V	EMPLA s.r.o. Hradec Králové	Hradec Králové hl.n.	Hradec Králové	PRODRA s.r.o.	www.prodra.cz
4215	V	Vlečka ZVU a.s.	Hradec Králové hl.n.	Hradec Králové	ČD Cargo, a.s.	www.cdcargo.cz
4216	V	Vlečka MTH Hradec Králové	Hradec Králové hl.n.	Hradec Králové	PRODRA s.r.o.	www.prodra.cz
4217	V	TSS Hradec Králové	Hradec Králové hl.n.	Hradec Králové	Traťová strojní společnost, a.s.	www.tssas.cz
4218	V	Vlečka INPOZ Hradec Králové	Hradec Králové hl.n.	Hradec Králové	PRODRA s.r.o.	www.prodra.cz
4219	V	Vlečka Areál ČKD Hradec Králové	Hradec Králové hl. n. - Všestary	Hradec Králové	PRODRA s.r.o.	www.prodra.cz
4221	V	Ferona, a.s. vlečka Hradec Králové - Slezské předměstí	Hradec Králové Slezské předm.	Hradec Králové	Ferona, a.s.	www.ferona.cz
4224	V	Vlečka Dr. Pio Kinský dal Borgo, Chlumec nad Cidlinou	Chlumec nad Cidlinou	Hradec Králové	PRODRA s.r.o.	www.prodra.cz
4228	V	Vlečka Pábl Jaroměř	Jaroměř	Hradec Králové	MBM rail s.r.o.	www.mbmr.cz
4229	V	RUND	Jaroměř	Hradec Králové	"STENO, v.o.s." - stavební a inženýrská činnost v kolejové dopravě	www.stenovos.cz
4230	V	Vlečka Rychnovek	Jaroměř - Česká Skalice	Hradec Králové	MBM rail s.r.o.	www.mbmr.cz
4232	V	MRAMORIT a.s.	Káranice	Hradec Králové	"STENO, v.o.s." - stavební a inženýrská činnost v kolejové dopravě	www.stenovos.cz
4233	V	Vlečka FAULHAMMER Kostelec nad Orlicí	Kostelec nad Orlicí	Hradec Králové	PRODRA s.r.o.	www.prodra.cz
4234	V	Agropodnik Jičín, sklad Lázně Bělohrad	Lázně Bělohrad	Liberec	Ing. Miroslav Holubář	www.provozdrah.cz
4235	V	Vlečka TIMKO-Lázně Bělohrad	Lázně Bělohrad	Liberec	Ing. Miroslav Holubář	www.provozdrah.cz
4236	V	Vlečka Natura DK Nový Bydžov	Nový Bydžov	Hradec Králové	NATURA DK, a.s.	www.naturadk.eu
4237	V	Vlečka Elektrárny Opatovice, a.s.	Opatovice nad Labem	Hradec Králové	Elektrárny Opatovice, a.s.	www.eop.cz
4238	V	Vlečka WLC Park Březhrad	Opatovice nad Labem-Pohřebačka	Hradec Králové	PRODRA s.r.o.	www.prodra.cz
4239	V	BOHEMILK, a.s., vlečka Opočno	Opočno pod Orlickými horami	Hradec Králové	DBV-ITL, s.r.o.	www.dbv-itl.cz
4240	V	Cukrovary TTD - České Meziříčí	Opočno pod Orlickými horami	Hradec Králové	Tereos TTD, a.s.	www.cukrovarytttd.cz
4241	V	Cerea, a.s. - vlečka Ostroměř	Ostroměř	Hradec Králové	DBV-ITL, s.r.o.	www.dbv-itl.cz
4243	V	Vlečka Pivovar Clock Potštejn	Potštejn	Česká Třebová	TrainPro s.r.o.	jan.chudina@trainpro.cz

1	2	3	4	5	6	7
4244	V	GNOL	Předměřice nad Labem	Hradec Králové	NOR a.s.	www.nor.cz
4245	V	Vlečka NAPOS Předměřice n. L.	Předměřice nad Labem	Hradec Králové	LOKO ŠMÍD s.r.o.	www.loko-smid.webnode.cz
4246	V	Vlečka Agropodnik a.s. Hradec Králové, stř. Sadová	Sadová	Hradec Králové	Agropodnik a.s. Hradec Králové	www.agropodnikhk.cz
4248	V	Cerea, a.s. - vlečka Smiřice	Smiřice	Hradec Králové	DBV-ITL, s.r.o.	www.dbv-itl.cz
4249	V	Vlečka Račice	Račice nad Trotinou	Hradec Králové	MBM rail s.r.o.	www.mbmr.cz
4250	V	Vlečka HOLOUBEK ENERGO a.s. Černožice nad Labem	Smiřice - Jaroměř	Hradec Králové	HOLOUBEK ENERGO a.s.	www.holoubekenergo.cz
4252	V	ŠKODA AUTO a.s.- Kvasiny II	Solnice	Hradec Králové	Pirell s.r.o.	www.pirell.cz
4253	V	ŠKODA AUTO Solnice	Solnice	Hradec Králové	České dráhy, a.s.	www.ceskedrahy.cz
4254	V	Preymesser Lipovka	Solnice - Častolovice	Hradec Králové	M.Preymesser logistika, spol. s r.o.	www.preymesser.de
4255	V	Vlečka DITON Čeperka	Stéblová	Hradec Králové	PRODRA s.r.o.	www.prodra.cz
4256	V	Progles, vlečka Šárovcová Lhota	Šárovcová Lhota	Liberec	DBV-ITL, s.r.o.	www.dbv-itl.cz
4257	V	Vlečka EKO-CONTAINER SERVICE Týniště nad Orlicí	Týniště nad Orlicí	Hradec Králové	PRODRA s.r.o.	www.prodra.cz
4258	V	Vojenská vlečka č. 28 - Týniště nad Orlicí	Týniště nad Orlicí	Hradec Králové	Armádní Servisní, příspěvková organizace	www.as-po.cz
4259	V	Vlečka Elitex reality	Týniště nad Orlicí	Hradec Králové	DBV-ITL, s.r.o.	www.dbv-itl.cz
4261	V	ESAB Vamberk	Vamberk	Hradec Králové	IDS CARGO a.s.	www.ids-cargo.cz
4262	V	Vlečka ČEZ Distribuce RO Všestary	Všestary	Hradec Králové	PRODRA s.r.o.	www.prodra.cz
4265	V	ŽELEZNIČNÍ MUZEUM JAROMĚŘ	Jaroměř	Hradec Králové	NOR a.s.	www.nor.cz
4266	V	Vlečka RSM Smiřice zastávka	Smiřice zastávka	Hradec Králové	České dráhy, a.s.	www.ceskedrahy.cz
4267	V	RSM Hradec Králové, ŽST Ostroměř	Ostroměř	Hradec Králové	České dráhy, a.s.	www.ceskedrahy.cz
4268	V	ČD, a.s. - Hradec Králové	Hradec Králové hl.n.	Hradec Králové	České dráhy, a.s.	www.ceskedrahy.cz
4269	V	Vlečka Jaroměř	Jaroměř	Hradec Králové	Správa železnic, státní organizace	www.spravazeleznic.cz
4270	V	JARO Ostroměř	Ostroměř	Hradec Králové	JARO Česká Skalice, s.r.o.	www.jarocs.eu
4271	V	Vlečka Společnosti železniční výtupna Jaroměř	Jaroměř	Hradec Králové	Rabbit Rail s.r.o.	www.rabrail.cz
4302	V	Černousy	Černousy	Liberec	"STENO, v.o.s." - stavební a inženýrská činnost v kolejové dopravě	www.stenovos.cz
4303	V	Gerhát Train - Hodkovice	Hodkovice nad Mohelkou	Liberec	"STENO, v.o.s." - stavební a inženýrská činnost v kolejové dopravě	www.stenovos.cz
4309	V	Vlečka TSR Jablonec n.N.	Jablonec nad Nisou	Liberec	"STENO, v.o.s." - stavební a inženýrská činnost v kolejové dopravě	www.stenovos.cz
4312	V	Vlečka ALFA VERUS	Liberec	Liberec	"STENO, v.o.s." - stavební a inženýrská činnost v kolejové dopravě	www.stenovos.cz
4313	V	Vlečka Severochema v.d.	Liberec	Liberec	Severochema, družstvo pro chemickou výrobu, Liberec	www.severochema.com

1	2	3	4	5	6	7
4314	V	Teplárny Liberec	Liberec	Liberec	ALLCORA, s.r.o.	www.allcora.cz
4315	V	Vlečka Babylon	Liberec	Liberec	"STENO, v.o.s." - stavební a inženýrská činnost v kolejové dopravě	www.stenovos.cz
4318	V	Magna Exteriors (Bohemia) s.r.o.	Liberec-Horní Růžodol	Liberec	"STENO, v.o.s." - stavební a inženýrská činnost v kolejové dopravě	www.stenovos.cz
4319	V	PERISINALE Ostašov	Karlov pod Ještědem - Liberec-Horní Růžodol	Liberec	DBV-ITL, s.r.o.	www.dbv-itl.cz
4320	V	Vlečka Hajniště	Řasnice - Nové Město pod Smrkem	Liberec	PRODRA s.r.o.	www.prodra.cz
4321	V	Vlečka Jan Štěrba Nové Město pod Smrkem	Nové Město pod Smrkem	Liberec	PRODRA s.r.o.	www.prodra.cz
4324	V	Ferona, a.s. vlečka Liberec - Rochlice	Liberec	Liberec	Ferona, a.s.	www.ferona.cz
4325	V	INTEX, vlečka Vesec u Liberce	Vesec u Liberce	Liberec	DBV-ITL, s.r.o.	www.dbv-itl.cz
4326	V	Vlečka ORNELA	Tanvald-Harachov, Desná-Dolní Polubný	Liberec	ČD Cargo, a.s.	www.cdcargo.cz
4327	V	Výtopna Frýdlantských okresních drah	Frýdlant v Čechách	Liberec	MBM rail s.r.o.	www.mbmr.cz
4328	V	Výtopna Kořenov	Kořenov	Liberec	Railway Capital a.s.	www.railwaycapital.cz
4329	V	ČD, a.s. - CHV Tanvald	Tanvald	Liberec	České dráhy, a.s.	www.ceskedrahy.cz
4330	V	ČD, a.s. - Liberec	Liberec	Liberec	České dráhy, a.s.	www.ceskedrahy.cz
4401	V	Cerea, a.s. - vlečka Cerekvice nad Loučnou	Cerekvice nad Loučnou	Česká Třebová	DBV-ITL, s.r.o.	www.dbv-itl.cz
4402	V	PRONTO GAS Čachnov	Čachnov	Česká Třebová	ALLCORA, s.r.o.	www.allcora.cz
4405	V	Cerea, a.s. - vlečka Hlinsko	Hlinsko v Čechách	Česká Třebová	DBV-ITL, s.r.o.	www.dbv-itl.cz
4407	V	BRAMAC, vlečka Hrochův Týnec	Hrochův Týnec	Česká Třebová	DBV-ITL, s.r.o.	www.dbv-itl.cz
4410	V	OSEVA UNI, a.s., Silo Vysoké Mýto	Choceň - Vysoké Mýto	Česká Třebová	DBV-ITL, s.r.o.	www.dbv-itl.cz
4411	V	Vlečka De Heus Běstovice	Choceň - Újezd u Chocně	Česká Třebová	PRODRA s.r.o.	www.prodra.cz
4415	V	Vlečka DADRUS	Chrast u Chrudimi	Česká Třebová	GJW Praha spol. s r.o.	www.gjw-praha.cz
4417	V	ONIVON a.s.	Chrudim	Česká Třebová	ONIVON a.s.	www.onivon.cz
4418	V	Éra plus	Chrudim město	Česká Třebová	DBV-ITL, s.r.o.	www.dbv-itl.cz
4419	V	Tereos TTD, a.s., vlečka Chrudim	Chrudim město	Česká Třebová	DBV-ITL, s.r.o.	www.dbv-itl.cz
4423	V	Vlečka Heřmanův Městec	Kostelec u Heřmanova Městce	Česká Třebová	JIPOK, s.r.o.	jipok.sro@volny.cz
4424	V	Cerea, a.s. - vlečka Dašice	Kostěnice	Česká Třebová	DBV-ITL, s.r.o.	www.dbv-itl.cz
4426	V	Vlečka Faulhammer, Litomyšl	Litomyšl	Česká Třebová	Firma FAULHAMMER s.r.o.	www.faulhammer.cz
4428	V	DEXTRA X	Pardubice hl.n.	Česká Třebová	"STENO, v.o.s." - stavební a inženýrská činnost v kolejové dopravě	www.stenovos.cz
4429	V	TOPEK - Oil.cz, a.s. vlečka Pardubice	Pardubice hl.n.	Česká Třebová	Dr. ZENKL s.r.o.	www.drzenkl.cz

1	2	3	4	5	6	7
4431	V	Vlečka Paramo, a.s. Pardubice	Pardubice	Česká Třebová	ORLEN Unipetrol Doprava s.r.o.	www.unipetroldoprava.cz
4432	V	enteria	Pardubice hl.n.	Česká Třebová	Chládek a Tintěra, Pardubice a.s.	www.cht-pce.cz
4436	V	Vlečka Synthesia	Pardubice-Rosice nad Labem	Česká Třebová	ORLEN Unipetrol Doprava s.r.o.	www.orlenunipetroldoprava.cz
4437	V	Vlečka Jarý - Pardubice	Pardubice-Rosice nad Labem	Česká Třebová	DBV-ITL, s.r.o.	www.dbv-itl.cz
4438	V	Vojenská vlečka č. 6 - Pardubice	Pardubice-Rosice nad Labem - Medlešice	Česká Třebová	Armádní Servisní, příspěvková organizace	www.as-po.cz
4440	V	Vlečka CEMEX	Prachovice	Česká Třebová	CEMEX Logistics, s.r.o.	www.transplus.cz
4441	V	EXCALIBUR ARMY, vlečka Přelouč	Přelouč	Česká Třebová	DBV-ITL, s.r.o.	www.dbv-itl.cz
4442	V	Cerea, a.s. - vlečka Přelouč	Přelouč	Česká Třebová	DBV-ITL, s.r.o.	www.dbv-itl.cz
4445	V	Cerea, a.s. - vlečka Řečany nad Labem	Řečany nad Labem	Česká Třebová	DBV-ITL, s.r.o.	www.dbv-itl.cz
4446	V	Vlečka Elektrárna Chvaletice	Řečany nad Labem	Česká Třebová	ČD Cargo, a.s.	www.cdcargo.cz
4449	V	Vlečka OQEMA Slatiňany	Slatiňany	Česká Třebová	PRODRA s.r.o.	www.prodra.cz
4450	V	Cerea, a.s. - vlečka Slatiňany	Slatiňany	Česká Třebová	CZ Logistics, s.r.o.	www.czlog.cz
4451	V	Vlečka TUNĚCHODY-CIHELNA	Úhřetice	Česká Třebová	GJW Praha spol. s r.o.	www.gjw-praha.cz
4454	V	Skanska a.s. - vlečka kamenolom Zárubka	Žďárec u Skutče - Chrást u Chrudimi	Česká Třebová	Skanska a.s.	www.skanska.cz
4459	V	ELKA 93	Chrudim město	Česká Třebová	MBM rail s.r.o.	www.mbmr.cz
4460	V	Vlečka RSM Záboří nad Labem	Záboří nad Labem	Česká Třebová	České dráhy, a.s.	www.ceskedrahy.cz
4462	V	RSM Hradec Králové, ŽST Zámorsk	Zámorsk	Česká Třebová	České dráhy, a.s.	www.ceskedrahy.cz
4464	V	ČD, a.s. - Choceň	Choceň	Česká Třebová	České dráhy, a.s.	www.ceskedrahy.cz
4465	V	ČD, a.s. - Pardubice	Pardubice hl.n.	Česká Třebová	České dráhy, a.s.	www.ceskedrahy.cz
4501	V	HORKALEN Bohuslavice nad Metují	Bohuslavice nad Metují	Hradec Králové	Česká republika - Správa státních hmotných rezerv	www.sshr.cz
4502	V	Veba a.s. Broumov, vlečka Broumov	Broumov	Hradec Králové	NOR a.s.	www.nor.cz
4503	V	Veba a.s. Broumov, vlečka Broumov Olivětín	Broumov-Olivětín	Hradec Králové	NOR a.s.	www.nor.cz
4504	V	AGRO CS a.s.	Jaroměř - Česká Skalice	Liberec	NOR a.s.	www.nor.cz
4506	V	KRPA Hostinné - nová	Hostinné	Liberec	KRPA PAPER, a.s.	www.krpa-paper.cz
4508	V	Devro s.r.o.	Hrabačov	Liberec	ALLCORA, s.r.o.	www.allcora.cz
4509	V	Wikov Hronov	Hronov	Hradec Králové	Ing. Miloslav Šmíd	vlecky.smid@seznam.cz
4511	V	Krkonošské vápenky Kunčice, vlečka Kunčice nad Labem	Kunčice nad Labem	Liberec	DBV-ITL, s.r.o.	www.dbv-itl.cz
4513	V	Vlečka Zdeněk Bejr Malé Svatoňovice	Malé Svatoňovice	Hradec Králové	PRODRA s.r.o.	www.prodra.cz

1	2	3	4	5	6	7
4516	V	PROMA REHA MEZIMĚSTÍ	Meziměstí	Hradec Králové	LOKO ŠMÍD s.r.o.	www.loko-smid.webnode.cz
4517	V	AGRO CS a.s. - vlečka Meziměstí	Meziměstí	Hradec Králové	NOR a.s.	www.nor.cz
4518	V	Lesní společnost Broumov, vlečka Meziměstí	Meziměstí	Hradec Králové	LOKO ŠMÍD s.r.o.	www.loko-smid.webnode.cz
4522	V	Coca-Cola HBC Česko a Slovensko, s.r.o. Teplice nad Metují	Teplice nad Metují	Hradec Králové	Pirell s.r.o.	www.pirell.cz
4524	V	Vlečka ČEZ, a.s. - elektrárna Poříčí	Trutnov střed	Hradec Králové	SD – Kolejová doprava, a.s.	www.sd-kd.cz
4525	V	Cerea, a.s. - vlečka Trutnov	Trutnov střed	Hradec Králové	DBV-ITL, s.r.o.	www.dbv-itl.cz
4527	V	Krkonošské vápenky Kunčice, vlečka Vrchlabí	Vrchlabí	Liberec	DBV-ITL, s.r.o.	www.dbv-itl.cz
4528	V	Vlečka RSM Rokytnice nad Jizerou	Rokytnice nad Jizerou	Liberec	České dráhy, a.s.	www.ceskedrahy.cz
4530	V	ČD, a.s. - Dobruška	Dobruška	Hradec Králové	České dráhy, a.s.	www.ceskedrahy.cz
4531	V	ČD, a.s. - Jilemnice	Jilemnice	Liberec	České dráhy, a.s.	www.ceskedrahy.cz
4532	V	ČD, a.s. - Trutnov	Trutnov hl.n.	Hradec Králové	České dráhy, a.s.	www.ceskedrahy.cz
4534	V	ČD, a.s. - Meziměstí	Meziměstí	Hradec Králové	České dráhy, a.s.	www.ceskedrahy.cz
4535	V	ČD, a.s. - Náchod	Náchod	Hradec Králové	České dráhy, a.s.	www.ceskedrahy.cz
4601	V	BUTAS Butoves	Butoves	Liberec	Česká republika - Správa státních hmotných rezerv	www.sshr.cz
4603	V	Seco Industries, s.r.o., vlečka Jičín	Jičín	Liberec	DBV-ITL, s.r.o.	www.dbv-itl.cz
4604	V	Cerea, a.s. - vlečka Jičín	Jičín	Liberec	DBV-ITL, s.r.o.	www.dbv-itl.cz
4606	V	TEC Cukrovar Kopidlno a.s.	Kopidlno	Liberec	"STENO, v.o.s." - stavební a inženýrská činnost v kolejové dopravě	www.stenovos.cz
4607	V	Vlečka Kamenolom Košťálov	Košťálov	Liberec	"STENO, v.o.s." - stavební a inženýrská činnost v kolejové dopravě	www.stenovos.cz
4608	V	Vlečka Sklopísek Střeleč a.s.	Libuň	Liberec	ČD Cargo, a.s.	www.cdcargo.cz
4609	V	Vlečka VELVETA Varnsdorf - provoz Nová Paka	Nová Paka	Liberec	Ing. Miroslav Holubář	www.provozdrah.cz
4610	V	AWENOR	Příšovice	Liberec	"STENO, v.o.s." - stavební a inženýrská činnost v kolejové dopravě	www.stenovos.cz
4612	V	Agropodnik Jičín, sklad Sobotka	Sobotka	Liberec	Ing. Miroslav Holubář	www.provozdrah.cz
4613	V	Vlečka M-SILNICE a.s. - obalovna Staré Místo	Staré Místo u Jičína	Liberec	Ing. Miroslav Holubář	www.provozdrah.cz
4614	V	Vlečka R.F. PROFI Turnov	Turnov	Liberec	Ing. Miroslav Holubář	www.provozdrah.cz
4615	V	ČD, a.s. - CHV Turnov	Turnov	Liberec	České dráhy, a.s.	www.ceskedrahy.cz
4616	V	JARO Kopidlno	Kopidlno	Liberec	JARO Česká Skalice, s.r.o.	www.jarocs.eu
4617	V	ČD, a.s. - Stará Paka	Stará Paka	Liberec	České dráhy, a.s.	www.ceskedrahy.cz
4901	V	Skladový areál MR Chrast u Chrudimi	Chrast u Chrudimi	Česká Třebová	Česká republika - Správa státních hmotných rezerv	www.spravazeleznic.cz
5001	V	EXPONO Steelforce, a.s., Adamov	Adamov	Brno	PRODACH CZ, s.r.o.	prodach.sro@seznam.cz

1	2	3	4	5	6	7
5002	V	Mendelova univerzita v Brně, Dřevosklad Adamov	Adamov	Brno	ČD Cargo, a.s.	www.cdcargo.cz
5004	V	ZZN - provozní středisko Batelov	Batelov	Jihlava	ZZN Jihlava a.s.	www.zznjihlava.cz
5006	V	Českomoravský štěrka, a.s., vlečka pískovna Božice	Božice u Znojma	Břeclav	Českomoravský cement, a.s.	www.heidelbergcement.cz
5007	V	Land - Product a.s.	Božice u Znojma	Břeclav	Land - Product a.s.	www.land-product.com
5009	V	Českomoravský cement, a.s., závod Mokrá	Blažovice	Brno	Českomoravský cement, a.s.	www.heidelbergcement.cz
5014	V	Metalšrot Tlumačov a.s. - vlečka Brno	Brno dolní nádraží	Brno	OLSPED, s.r.o.	www.olsped.cz
5017	V	Ferona, a.s. vlečka Brno - Horní Heršpice	Brno-Horní Heršpice	Brno	Ferona, a.s.	www.ferona.cz
5020	V	Terminal Brno	Brno-jih	Brno	ČD Cargo, a.s.	www.cdcargo.cz
5022	V	RAVEN CZ Brno-Chrlice	Brno-Chrlice	Brno	Dr. ZENKL s.r.o.	www.drzenkl.cz
5023	V	Teplárny Brno, a.s. - provoz Červený mlýn	Brno-Královo pole	Brno	BF Logistics s.r.o.	www.bfl.cz
5026	V	KRÁLOVOPOLSKÁ, a.s.	Brno-Královo Pole	Brno	Vladimír Hofman provozování dráhy a drážní dopravy	www.kralovopolska.cz
5027	V	Dopravní podnik města Brna	Brno-Královo Pole	Brno	Dopravní podnik města Brna, a.s.	www.dpmb.cz
5028	V	Škrobárna Reality, a.s.	Brno-Maloměřice	Brno	PRODACH CZ, s.r.o.	prodach.sro@seznam.cz
5030	V	Teplárny Brno, a.s. - provoz Špitálka	Brno-Maloměřice	Brno	BF Logistics s.r.o.	www.bfl.cz
5032	V	Šmeral Brno, a.s.	Brno-Maloměřice	Brno	DBV-ITL, s.r.o.	www.dbv-itl.cz
5037	V	Tomáš Novotný - Cementárna Maloměřice	Brno-Maloměřice	Brno	Českomoravský cement, a.s.	www.heidelbergcement.cz
5039	V	AREAL SLATINA, a.s.	Brno-Slatina	Brno	AREAL SLATINA, a.s.	www.areaslatina.cz
5046	V	Brno - Slatina	Brno-Slatina	Brno	OHL ŽS, a.s.	www.ohlzs.cz
5047	V	Vlečka Letiště Brno - Tuřany	Brno-Slatina	Brno	LETIŠTĚ BRNO a.s.	www.brno-airport.cz
5050	V	GUMOTEX	Břeclav	Břeclav	M-DOPRASPOL, s.r.o.	f.sebek@quick.cz
5054	V	FOSFA, a.s.	Boří Les	Břeclav	PKP CARGO INTERNATIONAL a.s.	www.pkpcargointernational.com
5055	V	Poštorenské keramické závody	Boří Les	Břeclav	Dr. ZENKL s.r.o.	www.drzenkl.cz
5058	V	Vojenská vlečka č. 2 - Bučovice	Bučovice	Břeclav	Armádní Servisní, příspěvková organizace	www.as-po.cz
5059	V	SAGRAS, a.s. Bystřice nad Pernštejnem	Bystřice nad Pernštejnem	Jihlava	OLSPED, s.r.o.	www.olsped.cz
5061	V	KM BETA a.s.	Bzenec přívoz	Břeclav	KM BETA a.s.	www.kmbeta.cz
5062	V	Vlečka výroby SMS - KM BETA a.s.	Bzenec přívoz	Břeclav	KM BETA a.s.	www.kmbeta.cz
5063	V	FIRON, spol. s r.o.	Čejč	Břeclav	PRODACH CZ, s.r.o.	prodach.sro@seznam.cz
5065	V	NAVOS, a.s. - vlečka Dačice	Dačice	Jihlava	Dr. ZENKL s.r.o.	www.drzenkl.cz
5068	V	Vojenská vlečka č. 27 - Dobronín	Dobronín	Jihlava	Armádní Servisní, příspěvková organizace	www.as-po.cz

1	2	3	4	5	6	7
5073	V	RICO Havlíčkův Brod	Havlíčkův Brod	Jihlava	Chládek a Tintěra Havlíčkův Brod, a.s.	www.chladek-tintera.cz
5079	V	Vlečka Amylon Havlíčkův Brod	Havlíčkův Brod	Jihlava	Amylon, a.s.	www.amylon.cz
5080	V	Cerea, a.s. - vlečka Havlíčkův Brod - Baštinov	Havlíčkův Brod	Jihlava	DBV-ITL, s.r.o.	www.dbv-itl.cz
5081	V	SLADOVNY SOUFFLET ČR, a.s., závod Hodonice	Hodonice	Břeclav	BF Logistics s.r.o.	www.bfl.cz
5082	V	NAVOS, a.s. - vlečka Hodonice	Hodonice	Břeclav	Dr. ZENKL s.r.o.	www.drzenkl.cz
5083	V	ČEZ a.s., Elektrárna Hodonín	Hodonín	Břeclav	SD - Kolejová doprava, a.s.	www.sd-kd.cz
5089	V	Jihomoravská armaturka, spol. s r.o., Hodonín	Hodonín	Břeclav	PRODACH CZ, s.r.o.	prodach.sro@seznam.cz
5090	V	Cukrovar Hrušovany nad Jevišovkou	Hrušovany nad Jevišovkou - Šanov	Břeclav	BF Logistics s.r.o.	www.bfl.cz
5091	V	AGROCENTRUM HRUŠOVANY, spol. s r.o.	Hrušovany nad Jevišovkou - Šanov	Břeclav	BF Logistics s.r.o.	www.bfl.cz
5093	V	YTONG Hrušovany u Brna	Hrušovany u Brna	Břeclav	Dr. ZENKL s.r.o.	www.drzenkl.cz
5095	V	DH DEKOR Humpolec	Humpolec	Jihlava	Dr. ZENKL s.r.o.	www.joannes.cz
5098	V	WATER 4 LIFE Humpolec	Humpolec	Jihlava	Dr. ZENKL s.r.o.	www.drzenkl.cz
5101	V	Chotěbořské strojírny	Chotěboř	Jihlava	GJW Praha spol. s r.o.	www.gjw-praha.cz
5103	V	Cerea, a.s. - vlečka Chotěboř, silo	Chotěboř	Jihlava	DBV-ITL, s.r.o.	www.dbv-itl.cz
5105	V	Vojenská vlečka č. 26 - Chotěboř-Bílek	Chotěboř	Jihlava	Armádní Servisní, příspěvková organizace	www.as-po.cz
5106	V	SLADOVNY SOUFFLET ČR, a.s., závod Kroměříž, vlečka Ivanovice na Hané	Ivanovice na Hané	Brno	BF Logistics s.r.o.	www.bfl.cz
5107	V	NAVOS, a.s. - vlečka Ivančice	Ivančice	Břeclav	Dr. ZENKL s.r.o.	www.drzenkl.cz
5109	V	Uhelné sklady Jihlava	Jihlava město	Jihlava	Railway Capital a.s.	www.railwaycapital.cz
5110	V	KRONOSPAN Jihlava	Jihlava	Jihlava	SILVA CZ, s.r.o.	www.kronospan.cz
5114	V	Českomoravský štěrk, a.s., vlečka kamenolom Kosov	Luka nad Jihlavou - Jihlava	Jihlava	Českomoravský cement, a.s.	www.heidelbergcement.cz
5116	V	ADW AGRO, a.s., středisko Kojetice na Moravě	Kojetice na Moravě	Jihlava	ADW AGRO, a.s.	www.adw.cz
5118	V	Kostelecké uzeniny a.s. - vlečka Kostelec	Kostelec u Jihlavy	Jihlava	Lovochemie, a.s.	www.lovochemie.cz
5124	V	VETROPACK MORAVIA GLASS	Kyjov	Břeclav	BPS-Prastav, s.r.o.	www.bps-prastav.cz
5126	V	Šroubárna Kyjov	Kyjov	Břeclav	LOKOTRANS SERVIS s.r.o.	www.lokotransservis.cz
5130	V	WOOD FOREST GROUP-Ledeč nad Sázavou	Ledeč nad Sázavou	Jihlava	Dr. ZENKL s.r.o.	www.drzenkl.cz
5131	V	ZOS a.s., Leština	Leština u Světlé	Jihlava	PRODACH CZ, s.r.o.	prodach.sro@seznam.cz
5134	V	UVR Mníšek pod Brdy a.s.	Lužice	Břeclav	PKP CARGO INTERNATIONAL a.s.	www.pkpcargointernational.com
5139	V	NAVOS, a.s. - vlečka Miroslav	Miroslav	Břeclav	Dr. ZENKL s.r.o.	www.drzenkl.cz

1	2	3	4	5	6	7
5140	V	Vlečka Remet Modřice	Modřice	Břeclav	REMET, spol. s r.o.	www.remet.net
5143	V	Ferona, a.s. vlečka Brno - Modřice	Modřice	Břeclav	BF Logistics s.r.o.	www.bfl.cz
5154	V	FIRESTA Modřice	Modřice	Břeclav	Jiřina Stěpánková	jistep2@seznam.cz
5155	V	AGROVÝKUP, a.s.	Moravské Budějovice	Jihlava	Agrovýkup, a.s.	www.agrovypkup.cz
5156	V	Vlečka Čech odpady Jemnice	Jemnice	Břeclav	CityRail, a.s.	www.cityrail.cz
5160	V	PBS INDUSTRY, a.s., vlečka Moravský Krumlov	Moravský Krumlov	Břeclav	BF Logistics s.r.o.	www.bfl.cz
5161	V	Vlečka Moravský Písek	Moravský Písek	Břeclav	BF Logistics s.r.o.	www.bfl.cz
5165	V	Vojenská vlečka č. 8 Náměšť nad Oslavou	Náměšť nad Oslavou	Břeclav	Armádní Servisní, příspěvková organizace	www.as-po.cz
5167	V	Koryna nábytek a.s.	Nemotice	Břeclav	"STENO, v.o.s." - stavební a inženýrská činnost v kolejové dopravě	www.stenovos.cz
5168	V	JAROKOV CARGO	Nová Cerekev	Jihlava	ALLCORA, s.r.o.	www.allcora.cz
5169	V	STOPR, s.r.o. - vlečka Nové Město na Moravě	Nové Město na Moravě	Jihlava	Provozování dráhy, kolejové stavby a servis Tomáš Brýda	tomas.bryda@gmail.com
5170	V	NAVOS, a.s. - vlečka Olbramkostel	Olbramkostel	Břeclav	Dr. ZENKL s.r.o.	www.drzenkl.cz
5171	V	EIT Trading, vlečka Okříšky	Okříšky	Jihlava	DBV-ITL, s.r.o.	www.dbv-itl.cz
5172	V	ADW AGRO, a.s., středisko Krahulov	Krahulov	Jihlava	ADW AGRO, a.s.	www.adw.cz
5173	V	ADW AGRO, a.s., středisko Krahulov II	Krahulov	Jihlava	ADW AGRO, a.s.	www.adw.cz
5176	V	Dřevozpracující družstvo Lukavec	Pacov	Jihlava	Dr. ZENKL s.r.o.	www.drzenkl.cz
5177	V	ZZN Pelhřimov - středisko Pacov	Pacov	Jihlava	Dr. ZENKL s.r.o.	www.drzenkl.cz
5178	V	AGROSTROJ Pelhřimov	Pelhřimov	Jihlava	ALLCORA, s.r.o.	www.allcora.cz
5180	V	ZZN Pelhřimov	Pelhřimov	Jihlava	Dr. ZENKL s.r.o.	www.drzenkl.cz
5181	V	ZZN Pelhřimov - Agroalfa	Pelhřimov	Jihlava	Dr. ZENKL s.r.o.	www.drzenkl.cz
5183	V	NAVOS, a.s. - vlečka Podivín	Podivín	Břeclav	Dr. ZENKL s.r.o.	www.drzenkl.cz
5184	V	Českomoravský štěrk, a.s., vlečka kamenolom Pohled	Pohled	Jihlava	Českomoravský cement, a.s.	www.heidelbergcement.cz
5189	V	NAVOS, a.s. - vlečka Rakšice	Rakšice	Břeclav	Dr. ZENKL s.r.o.	www.drzenkl.cz
5190	V	Českomoravský štěrk, a.s., vlečka kamenolom Olbramovice	Rakšice	Břeclav	Českomoravský cement, a.s.	www.heidelbergcement.cz
5191	V	ČEZ, a.s. Jaderná elektrárna Dukovany	Rakšice	Břeclav	A K O R s.r.o.	firma.akor@seznam.cz
5192	V	Lesy města Brna, a.s.	Rájec-Jestřebí	Brno	Lesy města Brna, a.s.	www.lesymb.cz
5193	V	VIA-REK s.r.o. Rájec-Jestřebí	Rájec-Jestřebí	Brno	Pirell s.r.o.	www.pirell.cz
5196	V	Ratíškovice - Rohatec	Rohatec	Břeclav	PKP CARGO INTERNATIONAL a.s.	www.pkpcargointernational.com
5198	V	SD FEROTECH, s.r.o.	Rohatec	Břeclav	SD Ferotech s.r.o.	www.sdferotech.cz
5201	V	EUROKAPITAL s.r.o. - vlečka Rohatec	Rohatec	Břeclav	PKP CARGO INTERNATIONAL a.s.	www.pkpcargointernational.com

1	2	3	4	5	6	7
5202	V	NAVOS, a.s. - vlečka Rohatec	Rohatec	Břeclav	Dr. ZENKL s.r.o.	www.drzenkl.cz
5206	V	DIAMO - Dolní Rožínka	Rožná - Bystřice nad Pernštejnem	Jihlava	DIAMO, státní podnik	www.diamo.cz
5207	V	Lesní družstvo obcí Příbyslav, vlečka Sázava	Sázava u Žďáru	Jihlava	GJW Praha spol. s r.o.	www.gjw-praha.cz
5209	V	Železniční vlečka VOP Skalice nad Svitavou	Skalice nad Svitavou	Brno	Petr Šrůtek s.r.o.	petr.srutek@seznam.cz
5214	V	ACHP Slavkov, a.s.	Slavkov u Brna	Břeclav	OLSPED, s.r.o.	www.olsped.cz
5215	V	Chemis engine a.s.	Slavkov u Brna	Břeclav	OLSPED, s.r.o.	www.olsped.cz
5216	V	Wotan Forest, a.s. - vlečka Slavonice II	Slavonice	Jihlava	Lovochemie, a.s.	www.lovochemie.cz
5218	V	Wotan Forest, a.s. - vlečka Slavonice	Slavonice	Jihlava	Lovochemie, a.s.	www.lovochemie.cz
5220	V	EG.D, a.s. - rozvodna Sokolnice	Brno-Chrlice - Sokolnice-Telnice	Brno	BF Logistics s.r.o.	www.bfl.cz
5221	V	ŠROT GEBESHUBER s.r.o. - Sokolnice	Sokolnice-Telnice	Brno	SEP, spol. s r.o.	mitric.sep@centrum.cz
5222	V	NAVOS, a.s. - vlečka Strážnice	Strážnice	Břeclav	Dr. ZENKL s.r.o.	www.drzenkl.cz
5223	V	Vlečka Střelice	Střelice	Břeclav	"STENO, v.o.s." - stavební a inženýrská činnost v kolejové dopravě	www.stenovos.cz
5229	V	NAVOS, a.s. - vlečka Hustopeče	Šakvice	Břeclav	Dr. ZENKL s.r.o.	www.drzenkl.cz
5233	V	Vlečka Šlapanov	Šlapanov	Jihlava	"STENO, v.o.s." - stavební a inženýrská činnost v kolejové dopravě	www.stenovos.cz
5237	V	ZZN - provozní středisko Telč	Třešť	Jihlava	ZZN Jihlava a.s.	www.zznjihlava.cz
5238	V	Vlečka STARKON Vysočina s.r.o. - Telč	Telč	Jihlava	Provozování dráhy, kolejové stavby a servis Tomáš Brýda	tomas.bryda@gmail.com
5244	V	Vlečka Čebín	Tišnov	Brno	PKP CARGO INTERNATIONAL a.s.	www.pkpcargointernational.com
5252	V	AGROPODNIK, a.s., Velké Meziříčí	Velké Meziříčí - Studenec	Brno	AGROPODNIK, a.s., Velké Meziříčí	www.agpas.cz
5257	V	Vlečka odboru 05 Logistika Velké Opatovice	Velké Opatovice	Brno	DOPAZ s.r.o.	www.dopaz.cz
5259	V	KORDÁRNA Plus a.s., Velká nad Veličkou	Velká nad Veličkou	Břeclav	KORDÁRNA Plus a.s.	www.kordarna.cz
5260	V	vlečka Železářny Veselí	Veselí nad Moravou	Břeclav	FERROMET a.s.	www.ferromet.cz
5261	V	A+S, s.r.o.	Vlkoš	Břeclav	A + S, s.r.o.	www.a-s.cz
5262	V	OSOČKAN Vlkov	Vlkov u Tišnova	Brno	Elektrizace železnic Praha a.s.	www.elzel.cz
5262	V	OSOČKAN, Vlkov	Vlkov u Tišnova	Brno	Česká republika - Správa státních hmotných rezerv	www.sshr.cz
5263	V	EŽ Praha a.s. - Vlkov u Tišnova	Vlkov u Tišnova	Brno	Elektrizace železnic Praha a.s.	www.elzel.cz

1	2	3	4	5	6	7
5266	V	Lesy České republiky s.p., vlečka Vranovice	Vranovice	Břeclav	DBV-ITL, s.r.o.	www.dbv-itl.cz
5267	V	D.P.S. Trade s.r.o.	Vyškov na Moravě	Brno	PRODACH CZ, s.r.o.	prodach.sro@seznam.cz
5268	V	LUKROM spol. s r.o., provoz Vyškov	Vyškov	Brno	LUKROM, spol. s r.o.	www.lukrom.cz
5273	V	ROSSO STEEL Zaječí	Zaječí	Břeclav	BF Logistics s.r.o.	www.bfl.cz
5274	V	LAUFEN CZ s.r.o., provozovna Znojmo	Znojmo	Jihlava	LAUFEN CZ s.r.o.	www.laufen.cz
5277	V	Vlečka COLAS Dyje	Hodonice - Znojmo	Břeclav	"STENO, v.o.s." - stavební a inženýrská činnost v kolejové dopravě	www.stenovos.cz
5280	V	ŽDAS, a.s.	Žďár nad Sázavou	Jihlava	ŽDAS, a.s.	www.zdas.cz
5281	V	Agroslužby Žďár nad Sázavou, a.s.	Veselíčko	Jihlava	"STENO, v.o.s." - stavební a inženýrská činnost v kolejové dopravě	www.stenovos.cz
5282	V	AGROPODNIK, a.s. silo Žďár nad Sázavou	Žďár nad Sázavou	Jihlava	AGROPODNIK, a.s., Velké Meziříčí	www.agpas.cz
5284	V	Stora Enso Wood Products Ždírec	Ždírec nad Doubravou	Jihlava	ČD Cargo, a.s.	www.cdcargo.cz
5287	V	Skladový areál MR Studenec	Studenec	Jihlava	Česká republika - Správa státních hmotných rezerv	www.sshr.cz
5288	V	GODULA Jihlávka	Jihlávka	Jihlava	Lesy České republiky, s.p.	www.lesycr.cz
5289	V	KOVOSTEEL, s.r.o., vlečka Hodonín	Hodonín	Břeclav	PRODACH CZ, s.r.o.	prodach.sro@seznam.cz
5291	V	SAKO Brno, a.s. - Slatina	Brno-Slatina	Brno	BF Logistics s.r.o.	www.bfl.cz
5296	V	GJW Havlíčkův Brod	Havlíčkův Brod	Jihlava	GJW Praha spol. s r.o.	www.gjw-praha.cz
5297	V	Harfa, Havlíčkův Brod	Havlíčkův Brod	Jihlava	Chládek a Tintěra Havlíčkův Brod, a.s.	www.chladek-tintera.cz
5298	V	Vlečka SŽDC Vranovice - Pohořelice	Vranovice	Brno	Správa železnic, státní organizace	www.spravazeleznic.cz
5299	V	CZ LOKO Jihlava	Jihlava	Jihlava	CZ Logistics, s.r.o.	www.czlog.cz
5300	V	Posvitavský vlečkový systém SŽDC	Brno-Židenice	Brno	Správa železnic, státní organizace	www.spravazeleznic.cz
5301	V	Stavební materiály Schaffer s.r.o.	Hulín	Valašské Meziříčí	OLSPED, s.r.o.	www.olsped.cz
5304	V	TOSHULIN, a.s.	Hulín	Valašské Meziříčí	TOSHULIN, a.s.	www.toshulin.cz
5305	V	Metalšrot Tlumačov a.s.	Tlumačov	Valašské Meziříčí	OLSPED, s.r.o.	www.olsped.cz
5307	V	Barum Continental	Otrokovice	Valašské Meziříčí	Bardos a.s.	www.bardos.cz
5308	V	PSG, a.s.	Otrokovice	Valašské Meziříčí	PRODACH CZ, s.r.o.	prodach.sro@seznam.cz
5309	V	TOMA, a.s.	Otrokovice	Valašské Meziříčí	Cargo Motion s.r.o.	www.cargom.cz
5310	V	Fatra, a.s., provoz Napajedla	Napajedla	Valašské Meziříčí	PRODACH CZ, s.r.o.	prodach.sro@seznam.cz
5311	V	Vlečka TAŽÍRNA OCELI - STARÉ MĚSTO, TRINECKÉ ŽELEZÁRNY, a.s.	Staré Město u Uherského Hradiště	Valašské Meziříčí	PELSPED, s.r.o.	pelsped@volny.cz
5312	V	COLORLAK, a.s.	Staré Město u Uherského Hradiště	Valašské Meziříčí	OLSPED, s.r.o.	www.olsped.cz

1	2	3	4	5	6	7
5315	V	KOVOSTEEL, s.r.o., vlečka Staré Město	Staré Město u Uherského Hradiště	Valašské Meziříčí	PRODACH CZ, s.r.o.	prodach.sro@seznam.cz
5318	V	TON Holešov	Holešov	Valašské Meziříčí	TON a.s.	www.ton.eu
5320	V	GEBESHUBER Kroměříž	Kroměříž	Valašské Meziříčí	SEP, spol. s r.o.	mitric.sep@centrum.cz
5321	V	SLADOVNY SOUFFLET ČR, a.s., vlečka Kroměříž	Kroměříž	Valašské Meziříčí	BF Logistics s.r.o.	www.bfl.cz
5322	V	NAVOS, a.s. - vlečka Kroměříž	Kroměříž	Valašské Meziříčí	Dr. ZENKL s.r.o.	www.drzenkl.cz
5323	V	NAVOS, a.s. - vlečka Kotojedy	Kroměříž	Valašské Meziříčí	Dr. ZENKL s.r.o.	www.drzenkl.cz
5326	V	ZPS - Transport a.s.	Otrokovice - Zlín Malenovice	Valašské Meziříčí	ZPS - TRANSPORT, a.s.	www.zps-transport.cz
5328	V	SVIT	Zlín střed	Valašské Meziříčí	Teplárna Zlín s.r.o.	www.7energy.com
5329	V	Vlečka METRANS a.s.	Lípa nad Dřevnicí	Valašské Meziříčí	METRANS, a.s.	www.metrans.eu
5334	V	Vlečka SŽDC Kunovice	Kunovice	Valašské Meziříčí	Správa železnic, státní organizace	www.spravazeleznic.cz
5335	V	Aircraft Industries, a.s., vlečka Kunovice	Kunovice - Ostrožská Nová Ves	Valašské Meziříčí	PRODACH CZ, s.r.o.	prodach.sro@seznam.cz
5336	V	DYAS.EU, a.s.	Uherský Ostroh	Valašské Meziříčí	PRODACH CZ, s.r.o.	prodach.sro@seznam.cz
5338	V	ŽPSV a.s. závod Uherský Ostroh	Uherský Ostroh	Valašské Meziříčí	Pirell s.r.o.	www.pirell.cz
5339	V	REC GROUP s.r.o., vlečka Uherský Brod	Uherský Brod	Valašské Meziříčí	PRODACH CZ, s.r.o.	prodach.sro@seznam.cz
5344	V	Slovácké strojírnny, a.s.	Uherský Brod	Valašské Meziříčí	Slovácké strojírnny, akciová společnost	www.sub.cz
5346	V	Ing. Karel Žáček	Bojkovice	Valašské Meziříčí	Lesnická kancelář Ilex s.r.o.	ilex@cmail.cz
5348	V	TSS Hulín	Hulín	Valašské Meziříčí	TSS Cargo a.s.	www.tsscargo.cz
5351	V	ZZN Pelhřimov - Chýnov	Chýnov	Jihlava	Dr. ZENKL s.r.o.	www.drzenkl.cz
5352	V	Vlečka SŽDC Havlíčkův Brod	Havlíčkův Brod	Jihlava	Správa železnic, státní organizace	www.spravazeleznic.cz
5353	V	Vlečka SŽDC Říkovice	Říkovice	Valašské Meziříčí	Správa železnic, státní organizace	www.spravazeleznic.cz
5401	V	OKV Břeclav	Břeclav	Břeclav	ČD Cargo, a.s.	www.cdcargo.cz
5402	V	OKV Brno Maloměřice	Brno-Maloměřice	Brno	ČD Cargo, a.s.	www.cdcargo.cz
5411	V	ČD, a.s. - Kroměříž	Kroměříž	Valašské Meziříčí	České dráhy, a.s.	www.ceskedrahy.cz
5412	V	ČD, a.s. - Otrokovice	Otrokovice	Valašské Meziříčí	České dráhy, a.s.	www.ceskedrahy.cz
5421	V	ČD, a.s. - Slavonice	Slavonice	Jihlava	České dráhy, a.s.	www.ceskedrahy.cz
5422	V	ČD, a.s. - Telč	Telč	Jihlava	České dráhy, a.s.	www.ceskedrahy.cz
5423	V	ČD, a.s. - Jemnice	Jemnice	Břeclav	České dráhy, a.s.	www.ceskedrahy.cz
5424	V	ČD, a.s. - Bystřice nad Pernštejnem	Bystřice nad Pernštejnem	Jihlava	České dráhy, a.s.	www.ceskedrahy.cz
5425	V	ČD, a.s. - Jihlava	Jihlava	Jihlava	České dráhy, a.s.	www.ceskedrahy.cz
5427	V	ČD, a.s. - Znojmo	Znojmo	Břeclav	České dráhy, a.s.	www.ceskedrahy.cz
5428	V	ČD, a.s. - Tišnov	Tišnov	Brno	České dráhy, a.s.	www.ceskedrahy.cz
5429	V	ČD, a.s. - TSV Brno hl. n.	Brno hlavní nádraží	Brno	České dráhy, a.s.	www.ceskedrahy.cz
5430	V	ČD, a.s. - Horní Heršpice	Brno-Horní Heršpice	Brno	České dráhy, a.s.	www.ceskedrahy.cz
5431	V	ČD, a.s. - Havlíčkův Brod	Havlíčkův Brod	Jihlava	České dráhy, a.s.	www.ceskedrahy.cz
5432	V	ČD, a.s. - Vranovice	Vranovice	Brno	České dráhy, a.s.	www.ceskedrahy.cz

1	2	3	4	5	6	7
5433	V	ČD, a.s. - Skalice nad Svitavou	Skalice nad Svitavou	Brno	České dráhy, a.s.	www.ceskedrahy.cz
5434	V	ČD, a.s. - Brno Maloměřice	Brno-Maloměřice	Brno	České dráhy, a.s.	www.ceskedrahy.cz
5435	V	ČD, a.s. - Brno d. n.	Brno dolní nádraží	Brno	České dráhy, a.s.	www.ceskedrahy.cz
5436	V	ČD, a.s. - Hodonín	Hodonín	Břeclav	České dráhy, a.s.	www.ceskedrahy.cz
5437	V	ČD, a.s. - CHV Kyjov	Kyjov	Břeclav	České dráhy, a.s.	www.ceskedrahy.cz
5438	V	ČD, a.s. - Veselí nad Moravou	Veselí nad Moravou	Břeclav	České dráhy, a.s.	www.ceskedrahy.cz
5439	V	Vlečka DPOV Veselí nad Moravou	Veselí nad Moravou	Břeclav	DPOV, a.s.	www.dpov.cz
5441	V	Vlečka SŽDC Humpolec	Humpolec	Jihlava	Správa železnic, státní organizace	www.spravazeleznic.cz
5446	V	ČD, a.s. - Hrušovany nad Jevišovkou	Hrušovany nad Jevišovkou - Šanov	Břeclav	České dráhy, a.s.	www.ceskedrahy.cz
5447	V	Vlečka Pávod	Jihlava	Jihlava	CZ Logistics, s.r.o.	www.czlog.cz
5448	V	Vlečka DEPO Zastávka U Brna	Zastávka u Brna	Břeclav	MBM rail s.r.o.	www.mbmr.cz
5449	V	Štěrkovka Havlíčkův Brod	Havlíčkův Brod	Jihlava	Chládek a Tintěra Havlíčkův Brod, a.s.	www.chladek-tintera.cz
5450	V	Vlečka SŽDC Nemotice – Koryčany	Nemotice	Břeclav	Správa železnic, státní organizace	www.spravazeleznic.cz
5901	V	Moravskoslezský kovošrot Znojmo	Znojmo	Jihlava	Moravskoslezský kovošrot, a.s.	www.mskovo.eu
6003	V	Nehlsen Třinec, s.r.o.	Třinec	Český Těšín	SLEZSKOMORAVSKÁ DRÁHA a.s.	www.slezskomoravskad raha.cz
6004	V	Vlečka Třinecké železárny, a.s., Třinec	Třinec	Český Těšín	TŘINECKÉ ŽELEZÁRNY, a.s.	www.trz.cz
6005	V	OKV Třinec	Třinec	Český Těšín	ČD Cargo, a.s.	www.cdcargo.cz
6008	V	Odvalová kolej č. 6a, 6b Louky n.O.	Louky nad Olší	Český Těšín	PKP CARGO INTERNATIONAL a.s.	www.pkpcargointernatio nal.com
6009	V	Vlečková síť OKD, Doprava, a.s.	Ostrava hl.n., Havířov, Louky nad Olší, Bohumín, Albrechtice u Českého Těšína	Ostrava, Český Těšín	PKP CARGO INTERNATIONAL a.s.	www.pkpcargointernatio nal.com
6014	V	METRANS - Šenov	Havířov	Český Těšín	METRANS, a.s.	www.metrans.eu
6015	V	Liberty Ostrava a.s.	Ostrava-Kunčice, Ostrava-Bartovice	Český Těšín	Liberty Ostrava a.s.	www.libertyostrava.cz
6017	V	Linde Gas a.s., výrobní centrum SC6 Ostrava Kunčice	Ostrava-Kunčice	Český Těšín	VA Progres s.r.o.	www.vaprogres.cz
6018	V	JANKOSTAV Ostrava Kunčice	Ostrava-Kunčice	Český Těšín	VA Progres s.r.o.	www.vaprogres.cz
6020	V	Vlečka Paskov	Vratimov	Český Těšín	PKP CARGO INTERNATIONAL a.s.	www.pkpcargointernatio nal.com
6021	V	STABRA CZ	Vratimov	Český Těšín	VA Progres s.r.o.	www.vaprogres.cz
6023	V	BIOCEL	Paskov	Český Těšín	ČD Cargo, a.s.	www.cdcargo.cz
6024	V	GO Steel Frýdek Místek	Lískovec u Frýdku	Český Těšín	GO Steel Frýdek Místek a.s.	www.gosteel.cz
6025	V	ARCIMPEX s.r.o. - Sviadnov	Lískovec u Frýdku	Český Těšín	ARCIMPEX s.r.o.	www.arcimpex.cz
6028	V	Pivovar RADEGAST	Dobrá u Frýdku	Český Těšín	SLEZSKOMORAVSKÁ DRÁHA a.s.	www.slezskomoravskad raha.cz
6029	V	HMMC Nošovice	Dobrá u Frýdku	Český Těšín	RAILLEX, a.s.	sprachal@raillex.cz

1	2	3	4	5	6	7
6030	V	W8 s.r.o. - Dobrá	Dobrá u Frýdku	Český Těšín	SLEZSKOMORAVSKÁ DRÁHA a.s.	www.slezskomoravskad raha.cz
6031	V	M+P prodej paliv Hnojník	Hnojník	Český Těšín	SLEZSKOMORAVSKÁ DRÁHA a.s.	www.slezskomoravskad raha.cz
6032	V	GODULA, Hnojník u Českého Těšína	Hnojník	Český Těšín	Česká republika - Správa státních hmotných rezerv	www.sshr.cz
6033	V	HK ŠROT s.r.o. - vlečka Baška	Baška	Český Těšín	SLEZSKOMORAVSKÁ DRÁHA a.s.	www.slezskomoravskad raha.cz
6035	V	SLEZSKOMORAVSKÁ DRÁHA a.s. - Frýdlant nad Ostravicí	Frýdlant nad Ostravicí	Český Těšín	SLEZSKOMORAVSKÁ DRÁHA a.s.	www.slezskomoravskad raha.cz
6040	V	Siemens, s.r.o. - Frenštát pod Radhoštěm	Frenštát pod Radhoštěm	Český Těšín	Dr. ZENKL s.r.o.	www.drzenkl.cz
6041	V	STRNADEL Frenštát	Frenštát pod Radhoštěm	Český Těšín	SLEZSKOMORAVSKÁ DRÁHA a.s.	www.slezskomoravskad raha.cz
6043	V	ČECOMET - Karviná	Karviná hl.n.	Český Těšín	SLEZSKOMORAVSKÁ DRÁHA a.s.	www.slezskomoravskad raha.cz
6044	V	KOVONA KARVINÁ, a.s.	Karviná město	Český Těšín	PKP CARGO INTERNATIONAL a.s.	www.pkpcargointernatio nal.com
6045	V	JÄKL Karviná, a.s.	Petrovice u Karviné - Karviná-Město	Český Těšín	ArcelorMittal Tubular Products Karviná a.s.	www.jakl.cz
6047	V	SALTAGRO a.s. - Petrovice u Karviné	Petrovice u Karviné	Český Těšín	SLEZSKOMORAVSKÁ DRÁHA a.s.	www.slezskomoravskad raha.cz
6049	V	Vlečka Dětmarovice	Dětmarovice	Český Těšín	PKP CARGO INTERNATIONAL a.s.	www.pkpcargointernatio nal.com
6051	V	Bochemie chemie	Bohumín	Český Těšín	DBV-ITL, s.r.o.	www.dbv-itl.cz
6052	V	GENETRIX Bohumín	Bohumín	Český Těšín	LOKO ŠMÍD s.r.o.	vlecky.smid@seznam.cz
6053	V	Vlečka MS UTILITIES & SERVICES a.s.	Bohumín	Český Těšín	ČD Cargo, a.s.	www.cdcargo.cz
6054	V	Vlečka ŽDB DRÁTOVNA	Bohumín	Český Těšín	ČD Cargo, a.s.	www.cdcargo.cz
6055	V	Bohumínská dráha	Bohumín	Český Těšín	Ing. Miloslav Šmíd	vlecky.smid@seznam.cz
6056	V	SANRE, spol. s r.o. - vlečka Bohumín	Bohumín	Český Těšín	SLEZSKOMORAVSKÁ DRÁHA a.s.	www.slezskomoravskad raha.cz
6057	V	Benzina, s.r.o., Sklad Nový Bohumín	Bohumín	Český Těšín	SLEZSKOMORAVSKÁ DRÁHA a.s.	www.slezskomoravskad raha.cz
6058	V	VADS BOHUMÍN	Bohumín	Český Těšín	PKP CARGO INTERNATIONAL a.s.	www.pkpcargointernatio nal.com
6060	V	Vlečka Heřmanice	Ostrava hl.n.	Ostrava	PKP CARGO INTERNATIONAL a.s.	www.pkpcargointernatio nal.com
6061	V	Vlečka Odra - Hrušov	Ostrava hl.n.	Ostrava	PKP CARGO INTERNATIONAL a.s.	www.pkpcargointernatio nal.com
6062	V	H-Zone, s.r.o. - Hrušov	Ostrava hl.n. - Hrušov	Ostrava	SLEZSKOMORAVSKÁ DRÁHA a.s.	www.slezskomoravskad raha.cz

1	2	3	4	5	6	7
6063	V	Vlečka Odra - uhelná služba	Ostrava hl.n.	Ostrava	PKP CARGO INTERNATIONAL a.s.	www.pkpcargointernational.com
6064	V	Vlečka Odra - základní závod	Ostrava hl.n.	Ostrava	PKP CARGO INTERNATIONAL a.s.	www.pkpcargointernational.com
6066	V	Pošta Ostrava 02	Ostrava hl.n.	Ostrava	Česká pošta, s.p.	www.ceskaposta.cz
6067	V	OHV Ostrava	Ostrava hl.n.	Ostrava	ČD Cargo, a.s.	www.cdcargo.cz
6068	V	ONV Ostrava	Ostrava hl.n.	Ostrava	ČD Cargo, a.s.	www.cdcargo.cz
6071	V	VÍTKOVICKÁ DOPRAVA	Ostrava střed, Ostrava-Vítkovice	Ostrava	VÍTKOVICKÁ DOPRAVA a.s.	www.vitkovice.cz
6072	V	LIBROS	Ostrava hl.n. - pravé nádraží	Ostrava	SLEZSKOMORAVSKÁ DRÁHA a.s.	www.slezskomoravskad raha.cz
6073	V	Manipulační kolej 2b, Ostrava - levé nádraží	Ostrava hl.n. - levé nádraží	Ostrava	PKP CARGO INTERNATIONAL a.s.	www.pkpcargointernational.com
6074	V	BorsodChem MCHZ, s.r.o. - vlečka Moravské chemické závody	Ostrava hl.n.	Ostrava	PKP CARGO INTERNATIONAL a.s.	www.pkpcargointernational.com
6075	V	Ridera Bohemia	Ostrava hl.n. - pravé nádraží	Ostrava	SLEZSKOMORAVSKÁ DRÁHA a.s.	www.slezskomoravskad raha.cz
6076	V	Ostravské opravny a strojírný, s.r.o., Ostrava	Ostrava hl.n.	Ostrava	Ostravské opravny a strojírný, s.r.o.	www.oossro.cz
6077	V	SLEZSKOMORAVSKÁ DRÁHA a.s. - Bdr	Ostrava hl.n.	Ostrava	SLEZSKOMORAVSKÁ DRÁHA a.s.	www.slezskomoravskad raha.cz
6078	V	TROJEK - Ostrava hl.n.-levé	Ostrava hl.n. - levé nádraží	Ostrava	SLEZSKOMORAVSKÁ DRÁHA a.s.	www.slezskomoravskad raha.cz
6079	V	Veolia Energie ČR - Třebovice	Ostrava-Svinov	Ostrava	PKP CARGO INTERNATIONAL a.s.	www.pkpcargointernational.com
6080	V	RAVEN Svinov	Ostrava-Svinov	Ostrava	VA Progres s.r.o.	www.vaprogres.cz
6081	V	Dopravní podnik Ostrava a.s. - Ostrava Třebovice	Ostrava-Třebovice	Ostrava	SLEZSKOMORAVSKÁ DRÁHA a.s.	www.slezskomoravskad raha.cz
6082	V	PORFIX Ostrava -Třebovice	Ostrava-Třebovice	Ostrava	SLEZSKOMORAVSKÁ DRÁHA a.s.	www.slezskomoravskad raha.cz
6083	V	MORSEVA OLOMOUC, čistící stanice osiv Háj ve Slezsku	Háj ve Slezsku	Ostrava	MORSEVA, spol. s r.o.	www.morseva.cz
6084	V	OPAVAN, Štítina u Opavy	Štítina	Ostrava	Česká republika - Správa státních hmotných rezerv	www.sshr.cz
6086	V	TEVA	Opava-Komárov	Ostrava	SLEZSKOMORAVSKÁ DRÁHA a.s.	www.slezskomoravskad raha.cz
6087	V	OSTROJ a.s.	Opava-východ	Ostrava	SLEZSKOMORAVSKÁ DRÁHA a.s.	www.slezskomoravskad raha.cz
6088	V	MODEL OBALY a.s., Opava	Opava-východ	Ostrava	SLEZSKOMORAVSKÁ DRÁHA a.s.	www.slezskomoravskad raha.cz
6089	V	Opavská lesní - Branka	Branka u Opavy	Ostrava	SLEZSKOMORAVSKÁ DRÁHA a.s.	www.slezskomoravskad raha.cz

1	2	3	4	5	6	7
6093	V	Gypstrend, s.r.o. Koberžice	Kravaře ve Slezsku	Ostrava	GYPSTREND s.r.o.	www.gypstrend.cz
6094	V	MSA Dolní Benešov	Dolní Benešov	Ostrava	SLEZSKOMORAVSKÁ DRÁHA a.s.	www.slezskomoravskad raha.cz
6096	V	Hospodářské družstvo Hlučín	Hlučín	Ostrava	VA Progres s.r.o.	www.vaprogres.cz
6098	V	OPAMETAL s.r.o. - Opava západ	Opava-západ	Ostrava	SLEZSKOMORAVSKÁ DRÁHA a.s.	www.slezskomoravskad raha.cz
6099	V	NAVOS, a.s. - vlečka Opava	Opava západ	Ostrava	Dr. ZENKL s.r.o.	www.drzenkl.cz
6100	V	Cukrovar Hrušovany nad Jevišovkou, a.s., závod Opava	Opava-západ	Ostrava	BF Logistics s.r.o.	www.bfl.cz
6101	V	Silo - Město Albrechtice	Město Albrechtice	Ostrava	Railway Capital a.s.	www.railwaycapital.cz
6102	V	KOS Krnov	Krnov	Ostrava	SLEZSKOMORAVSKÁ DRÁHA a.s.	www.slezskomoravskad raha.cz
6103	V	Veolia Energie ČR - Krnov	Krnov	Ostrava	PKP CARGO INTERNATIONAL a.s.	www.pkpcargointernatio nal.com
6105	V	Alfa Plastik, a.s. Bruntál	Bruntál	Ostrava	Alfa Plastik, a.s.	www.alfplastik.cz
6106	V	MACCO Bruntál	Bruntál	Ostrava	Petr Srůtek s.r.o.	petr.srutek@seznam.cz
6108	V	Větrovan	Bruntál - Malá Morávka	Ostrava	"STENO, v.o.s." - stavební a inženýrská činnost v kolejové dopravě	www.stenovos.cz
6109	V	AGROFOREST a.s.	Valšov	Ostrava	OLSPED, s.r.o.	www.olsped.cz
6110	V	KATR s.r.o. - vlečka Rýmařov	Rýmařov	Ostrava	KATR s.r.o.	www.katr.cz
6111	V	AL INVEST Břidličná a.s.	Břidličná	Ostrava	PELSPED, s.r.o.	pelsped@volny.cz
6112	V	DESPECTUS Investment s.r.o. - Dětřichov nad Bystřicí	Dětřichov nad Bystřicí	Ostrava	SLEZSKOMORAVSKÁ DRÁHA a.s.	www.slezskomoravskad raha.cz
6115	V	Vlečka TSR Polanka	Výhybna Polanka	Ostrava	"STENO, v.o.s." - stavební a inženýrská činnost v kolejové dopravě	www.stenovos.cz
6116	V	Českomoravský štěrk, a.s., vlečka překladiště Polanka	Výhybna Polanka	Ostrava	Českomoravský cement, a.s.	www.heidelbergcement. cz
6117	V	MSV Metal Studénka, a.s.	Studénka	Ostrava	Zdeněk Valchář - VA Progres	www.vaprogres.cz
6118	V	VSMS Studénka	Studénka	Ostrava	Ing. Petr Burian	petrburian@centrum.cz
6119	V	NAVOS, a.s. - vlečka Studénka	Studénka	Ostrava	Dr. ZENKL s.r.o.	www.drzenkl.cz
6121	V	Vlečka Sedlnice	Sedlnice	Ostrava	"STENO, v.o.s." - stavební a inženýrská činnost v kolejové dopravě	www.stenovos.cz
6122	V	TATRA TRUCKS a.s.	Kopřivnice	Ostrava	Zdeněk Valchář - VA Progres	www.vaprogres.cz
6123	V	Vlečka KOTOUČ ŠTRAMBERK	Štramberk	Ostrava	BPS-Prastav, s.r.o.	www.bps-prastav.cz
6124	V	NAVOS, a.s. - vlečka Suchdol nad Odrou	Suchdol nad Odrou	Ostrava	Dr. Zenkl s.r.o.	www.drzenkl.cz
6126	V	VOP CZ Šenov u Nového Jičína	Suchdol nad Odrou - Nový Jičín město	Ostrava	VA Progres s.r.o.	www.vaprogres.cz
6129	V	PARTR -Nový Jičín město	Nový Jičín město	Ostrava	VA Progres s.r.o.	www.vaprogres.cz
6130	V	Semperflex Optimit s.r.o.	Odry	Ostrava	Semperflex Optimit s.r.o.	lubomir.jindra@semperf lex.cz

1	2	3	4	5	6	7
6131	V	EUROVIA Jakubčovice	Odry - Heřmánky	Ostrava	SLEZSKOMORAVSKÁ DRÁHA a.s.	www.slezskomoravskad raha.cz
6132	V	Opavská lesní - Heřmánky	Odry - Heřmánky	Ostrava	SLEZSKOMORAVSKÁ DRÁHA a.s.	www.slezskomoravskad raha.cz
6136	V	RSPM Praha - vlečka Hranice	Hranice na Moravě	Olomouc	Ing. Miloslav Šmíd	vlecky.smid@seznam.cz
6137	V	ČEZ Distribuce, a.s. - rozvodna Hranice	Hranice na Moravě	Olomouc	SLEZSKOMORAVSKÁ DRÁHA a.s.	www.slezskomoravskad raha.cz
6138	V	Cement Hranice	Hranice na Moravě - Hranice na Moravě město	Olomouc	ČD Cargo, a.s.	www.cdcargo.cz
6139	V	DEZA Valašské Meziříčí	Lhotka nad Bečvou	Valašské Meziříčí	DEZA, a.s.	www.deza.cz
6140	V	Agropodnik a.s. Valašské Meziříčí	Valašské Meziříčí	Valašské Meziříčí	Agropodnik, a.s. Valašské Meziříčí	www.agropodnikas.cz
6141	V	CIE UNITOOLS PRESS a.s. Valašské Meziříčí	Valašské Meziříčí	Valašské Meziříčí	OLSPED, s.r.o.	www.olsped.cz
6144	V	Vlečka Loukov	Osíčko	Valašské Meziříčí	"STENO, v.o.s." - stavební a inženýrská činnost v kolejové dopravě	www.stenovos.cz
6145	V	Vojenská vlečka č. 21 - Loukov	Bystřice pod Hostýnem - Osíčko	Valašské Meziříčí	Armádní Servisní, příspěvková organizace	www.as-po.cz
6147	V	TON Bystřice pod Hostýnem	Bystřice pod Hostýnem	Valašské Meziříčí	TON a.s.	www.ton.eu
6150	V	ARPETA Hrachovec	Hrachovec	Valašské Meziříčí	VA Progres s.r.o.	www.vaprogres.cz
6151	V	Lesnicko-dřevařská firma, spol. s r.o. Rožnov pod Radhoštěm, vlečka Střítež nad Bečvou	Střítež nad Bečvou	Valašské Meziříčí	OLSPED, s.r.o.	www.olsped.cz
6156	V	VALSTEEL Bystřička	Bystřička	Valašské Meziříčí	ALLCORA, s.r.o.	www.allcora.cz
6157	V	Uhelné sklady Jablůnka	Jablůnka	Valašské Meziříčí	M.NAVY, s.r.o.	www.m-navy.cz
6158	V	DOLANKA Hovězí u Vsetína	Hovězí	Valašské Meziříčí	"STENO, v.o.s." - stavební a inženýrská činnost v kolejové dopravě	www.stenovos.cz
6159	V	OÚ Halenkov	Halenkov	Valašské Meziříčí	Ing. Jaroslav Vrba - obstaravatelské služby	vrbajaroslav@seznam.c z
6161	V	SYNOT REAL ESTATE - Karolinka	Karolinka	Valašské Meziříčí	"STENO, v.o.s." - stavební a inženýrská činnost v kolejové dopravě	www.stenovos.cz
6164	V	B.F.P., Lesy a statky T. Bati Vsetín	Vsetín	Valašské Meziříčí	OLSPED, s.r.o.	www.olsped.cz
6167	V	Kloboucká lesní s.r.o.	Bylnice	Valašské Meziříčí	PRODACH CZ, s.r.o.	prodach.sro@seznam.cz
6169	V	Českomoravský štěrk, a.s., vlečka Kamenolom Hrabůvka	Drahotuše	Olomouc	Českomoravský cement, a.s.	www.heidelbergcement. cz
6173	V	Hanácká potravinářská společnost s.r.o., cukrovar v Prosenicích	Prosenice	Olomouc	Mgr. Josef Tomeček	www.okridlenekolo.cz
6175	V	PRECHEZA Přerov	Přerov	Olomouc	PKP CARGO INTERNATIONAL a.s.	www.pkpcargointernatio nal.com
6176	V	Kazeto Přerov	Přerov	Olomouc	Petr Šrůtek s.r.o.	petr.srutek@seznam.cz

1	2	3	4	5	6	7
6177	V	Vlečka Rail Cargo Operator - CSKD s.r.o. Přerov	Přerov	Olomouc	DBV-ITL, s.r.o.	www.dbv-itl.cz
6178	V	OKV Přerov Lověšice	Přerov	Olomouc	ČD Cargo, a.s.	www.cdcargo.cz
6179	V	NAVOS, a.s. - vlečka Přerov	Přerov	Olomouc	Dr. ZENKL s.r.o.	www.drzenkl.cz
6180	V	Skladový areál MR Chropyně Rasina	Chropyně	Valašské Meziříčí	Česká republika - Správa státních hmotných rezerv	www.sshr.cz
6181	V	Energetika Chropyně, a.s.	Chropyně	Valašské Meziříčí	PRODACH CZ, s.r.o.	prodach.sro@seznam.cz
6182	V	Tereos TTD, a.s. Závod lihovar Kojetín	Kojetín	Valašské Meziříčí	BF Logistics s.r.o.	www.bfl.cz
6183	V	Českomoravský štěrk, a.s., vlečka štěrkopískovna Tovačov	Tovačov	Valašské Meziříčí	Českomoravský cement, a.s.	www.heidelbergcement.cz
6184	V	TOPOS PREFA Tovačov	Tovačov	Valašské Meziříčí	GJW Praha spol. s r.o.	www.gjw-praha.cz
6186	V	Cukrovar Brodek u Přerova	Brodek u Přerova	Olomouc	Dr. ZENKL s.r.o.	www.drzenkl.cz
6189	V	Vlečka ADM Olomouc	Olomouc hl.n.	Olomouc	IDS CARGO a.s.	www.ids-cargo.cz
6190	V	Čokoládovny a.s., o.z. ZORA Olomouc	Olomouc hl.n.	Olomouc	OLSPED, s.r.o.	www.www.olsped.cz
6191	V	Pošta Olomouc 02	Olomouc hl.n.	Olomouc	Česká pošta, s.p.	www.ceskaposta.cz
6192	V	SOLNĚ MLÝNY Olomouc	Olomouc hl.n.	Olomouc	OLSPED, s.r.o.	www.www.olsped.cz
6194	V	FARMAK Olomouc	Olomouc hl.n.	Olomouc	FARMAK, a.s.	www.farmak.cz
6195	V	Pivovar Litovel a.s. závod Olomouc	Olomouc hl.n.	Olomouc	Pivovar Litovel a.s.	www.litovel.cz
6197	V	Vlečka TSR Olomouc	Olomouc hl.n.	Olomouc	"STENO, v.o.s." - stavební a inženýrská činnost v kolejové dopravě	www.stenovos.cz
6200	V	ISH Olomouc, a.s.	Olomouc hl.n.	Olomouc	OLSPED, s.r.o.	www.www.olsped.cz
6202	V	STAMEDOP a.s., Olomouc	Olomouc hl.n.	Olomouc	OLSPED, s.r.o.	www.www.olsped.cz
6203	V	Teplárna Olomouc	Olomouc hl.n. - Olomouc-Nová Ulice	Olomouc	BPS-Prastav, s.r.o.	www.bps-prastav.cz
6207	V	Moravské železářny a.s. Olomouc	Olomouc-Řepčín	Olomouc	UNEX Servis, s.r.o.	www.unex.cz
6209	V	DELTA ARMY Horka nad Moravou	Horka nad Moravou	Olomouc	DELTA ARMY, s.r.o.	nadvornik.delta@tiscali.cz
6210	V	Ferona, a.s. vlečka Velká Bystřice	Velká Bystřice	Olomouc	Ferona, a.s.	www.ferona.cz
6211	V	ZEMPOMARKET a.s. Bečváry, oblastní sklad Velká Bystřice	Velká Bystřice	Olomouc	ZEMPOMARKET a.s. Bečváry	www.zempo.cz
6212	V	Vojenská vlečka č. 3 - Libavá	Hlubočky - Mariánské Údolí	Olomouc	Armádní Servisní, příspěvková organizace	www.as-po.cz
6213	V	MORA MORAVIA, s.r.o., Hlubočky - Mariánské Údolí	Hlubočky - Mariánské Údolí	Olomouc	ČD Cargo, a.s.	www.cdcargo.cz
6216	V	ZAPA beton a.s. Hrubá Voda	Hlubočky - Hrubá Voda	Olomouc	Vlastimil Miček s.r.o.	www.zapa.cz
6217	V	PVK Šternberk	Šternberk	Olomouc	Petr Šrůtek s.r.o.	petr.srutek@seznam.cz
6218	V	VOP Šternberk	Šternberk	Olomouc	Petr Šrůtek s.r.o.	petr.srutek@seznam.cz

1	2	3	4	5	6	7
6220	V	Pila Uničov	Uničov	Olomouc	LOKO ŠMÍD s.r.o.	www.loko-smid.webnode.cz
6221	V	UNEX a.s. Uničov	Uničov - Újezd u Uničova	Olomouc	UNEX Servis, s.r.o.	www.unex.cz
6222	V	PREFA Troubelice	Troubelice	Olomouc	PREFA Troubelice a.s.	www.prefatroubelice.cz
6223	V	KATR a.s.-vlečka Troubelice	Troubelice	Olomouc	KATR a.s.	www.katr.cz
6225	V	Pars nova a.s.	Šumperk	Olomouc	ŠKODA PARS a.s.	www.skoda.cz
6226	V	Cembrit Moravia a.s. Šumperk	Šumperk	Olomouc	Petr Leštinský	www.cembrit.cz
6227	V	Vlečka TSR Šumperk	Šumperk	Olomouc	"STENO, v.o.s." - stavební a inženýrská činnost v kolejové dopravě	www.stenovos.cz
6228	V	Metalšrot Tlumačov a.s. - vlečka Šumperk	Šumperk	Olomouc	OLSPED, s.r.o.	www.www.olsped.cz
6229	V	Vojenská vlečka č. 18 - Štěpánov	Štěpánov	Olomouc	Armádní Servisní, příspěvková organizace	www.as-po.cz
6230	V	ČEZ Distribuce, a.s. - rozvodna Červenka	Červenka	Olomouc	SLEZSKOMORAVSKÁ DRÁHA a.s.	www.slezskomoravskad raha.cz
6233	V	Litovelská cukrovarna	Litovel	Olomouc	BF Logistics s.r.o.	www.bfl.cz
6235	V	Pivovar Litovel a.s.	Litovel předměstí	Olomouc	Pivovar Litovel a.s.	www.litovel.cz
6236	V	MJM Litovel, a.s. provoz Litovel	Litovel předměstí	Olomouc	Petr Šrůtek s.r.o.	petr.srutek@seznam.cz
6237	V	ALIBONA Litovel	Litovel předměstí - Mladeč	Olomouc	Alibona, a.s.	www.alibona.cz
6239	V	Vápenka Vitoul Měrotín	Mladeč	Olomouc	VÁPENKA VITOUL s.r.o.	www.vitoul.cz
6240	V	MJM Litovel a.s., provoz Blatec	Blatec	Valašské Meziříčí	Petr Šrůtek s.r.o.	petr.srutek@seznam.cz
6241	V	Cukrovar Vrbátky	Vrbátky	Valašské Meziříčí	Cukrovar Vrbátky a.s.	www.cukrovarvrbatky.c z
6242	V	DT - Výhybkárna a strojírna	Prostějov hl.n.	Valašské Meziříčí	DT-Výhybkárna a strojírna, a.s.	www.dtpv.cz
6245	V	PV-RECYKLACE Prostějov	Prostějov hl.n.	Valašské Meziříčí	Dr. ZENKL s.r.o.	www.drzenkl.cz
6246	V	SLADOVNY SOUFFLET ČR, a.s. - vlečka Prostějov	Prostějov hl.n.	Valašské Meziříčí	SLADOVNY SOUFFLET ČR, a.s.	www.slad.cz
6247	V	Vlečka TOMI-REMONT a.s. Prostějov	Prostějov hl.n. - Prostějov místní nádraží	Olomouc	TOMI-REMONT a.s.	www.tomi-remont.cz
6248	V	Metalšrot Tlumačov a.s. - vlečka Prostějov	Prostějov místní nádraží	Olomouc	OLSPED, s.r.o.	www.www.olsped.cz
6249	V	Vlečka ŽPSV, závod Doloplazy	Nezamyslice	Valašské Meziříčí	Pirell s.r.o.	www.pirell.cz
6250	V	SIGMA Lutín a.s.	Třebčín	Olomouc	SIGMA DOPRAVA spol. s r.o.	www.sigma-doprava.cz
6251	V	Vlečka Čelechovice na Hané	Čelechovice na Hané	Olomouc	"STENO, v.o.s." - stavební a inženýrská činnost v kolejové dopravě	www.stenovos.cz
6252	V	Prodej paliva Kostelec na Hané	Kostelec na Hané	Olomouc	"STENO, v.o.s." - stavební a inženýrská činnost v kolejové dopravě	www.stenovos.cz
6253	V	FORTE a.s. Mostkovice	Kostelec na Hané	Olomouc	OLSPED, s.r.o.	www.www.olsped.cz
6254	V	Javořice - Ptenský Dvorek	Ptení	Olomouc	IDS CARGO a.s.	www.ids-cargo.cz

1	2	3	4	5	6	7
6255	V	NAVOS, a.s. - vlečka Dzbel	Dzbel	Olomouc	Dr. ZENKL s.r.o.	www.drzenkl.cz
6256	V	Siemens Elektromotory s.r.o. Mohelnice	Mohelnice	Olomouc	SART - stavby a rekonstrukce a.s.	www.sart.cz
6257	V	Vlečka Pískovna Mohelnice	Mohelnice	Olomouc	Pirell s.r.o.	www.pirell.cz
6257	V	Kámen Mohelnice	Mohelnice	Olomouc	PKP CARGO INTERNATIONAL a.s.	www.pkpcargointernational.com
6259	V	Balsac papermill s.r.o. Lukavice 21	Lukavice na Moravě	Olomouc	Balsac papermill s.r.o.	www.balsac.cz
6260	V	Vápenka Vitošov, s.r.o.	Zábřeh na Moravě	Olomouc	VÁPENKA VITOŠOV s.r.o.	www.vapenka-vitosov.cz
6261	V	SKLADY ZÁBŘEH 001, s.r.o.	Zábřeh na Moravě	Olomouc	OLSPED, s.r.o.	www.www.olsped.cz
6262	V	OLMA, a.s. - vlečka Zábřeh	Zábřeh na Moravě	Olomouc	Lovochemie, a.s.	www.lovochemie.cz
6264	V	MJM Litovel a.s. provoz Bludov	Bludov	Olomouc	Petr Šrůtek s.r.o.	petr.srutek@seznam.cz
6265	V	OP papírna, s.r.o. vlečka Olšany	Ruda nad Moravou - Bludov	Olomouc	SLEZSKOMORAVSKÁ DRÁHA a.s.	www.slezskomoravskadrahazaha.cz
6266	V	Papírna Aloisov a.s.	Ruda nad Moravou	Olomouc	Papírna Aloisov a.s.	www.melecky.cz
6269	V	Pivovar HOLBA a.s. Hanušovice	Hanušovice	Olomouc	Pivovar HOLBA, a.s.	www.holba.cz
6271	V	Omya CZ s.r.o., vlečka Pomezí	Lipová Lázně jeskyně	Olomouc	SART - stavby a rekonstrukce a.s.	www.sart.cz
6272	V	Omya CZ s.r.o., vlečka Vápenná	Vápenná	Olomouc	SART - stavby a rekonstrukce a.s.	www.sart.cz
6274	V	AO - vlečka Vápenná	Vápenná	Olomouc	BPS-Prastav, s.r.o.	www.bps-prastav.cz
6276	V	Patriot Javorník s.r.o. - NAVOS, a.s.	Javorník ve Slezsku	Olomouc	Dr. ZENKL s.r.o.	www.drzenkl.cz
6278	V	Řetězárna a.s.	Jeseník - Písečná	Olomouc	Řetězárna a.s.	www.retezarna.cz
6279	V	IKB Slévárna Písečná	Písečná	Olomouc	SART - stavby a rekonstrukce a.s.	www.sart.cz
6280	V	AO - vlečka Písečná	Písečná	Olomouc	BPS-Prastav, s.r.o.	www.bps-prastav.cz
6282	V	Vlečka DPOV Přerov	Přerov	Olomouc	DPOV, a.s.	www.dpov.cz
6283	V	ČD, a.s. - Vsetín	Vsetín	Valašské Meziříčí	České dráhy, a.s.	www.ceskedrahy.cz
6285	V	Vlečka RSM Studénka	Studénka	Ostrava	České dráhy, a.s.	www.ceskedrahy.cz
6286	V	Vlečka RSM Kopřivnice	Kopřivnice	Ostrava	České dráhy, a.s.	www.ceskedrahy.cz
6287	V	Vlečka RSM Přerov	Přerov	Olomouc	České dráhy, a.s.	www.ceskedrahy.cz
6288	V	Vlečka RSM Brodek u Přerova	Brodek u Přerova	Olomouc	IDS CARGO a.s.	www.ids-cargo.cz
6289	V	REGENA Hranice	Hranice na Moravě	Olomouc	REGENA, spol. s r.o.	www.regena.cz
6290	V	Vlečka RSM Bohumín	Bohumín	Český Těšín	České dráhy, a.s.	www.ceskedrahy.cz
6292	V	ČD, a.s. - Lipová Lázně	Lipová Lázně	Olomouc	České dráhy, a.s.	www.ceskedrahy.cz
6294	V	ČD, a.s. - Šumperk	Šumperk	Olomouc	České dráhy, a.s.	www.ceskedrahy.cz
6295	V	ČD, a.s. - Přerov	Přerov	Olomouc	České dráhy, a.s.	www.ceskedrahy.cz
6296	V	Vlečka RSM Olomouc, ŽST Lhotka n.Bečvou	Lhotka nad Bečvou	Valašské Meziříčí	České dráhy, a.s.	www.ceskedrahy.cz
6297	V	ČD, a.s. - Osoblaha	Osoblaha	Ostrava	České dráhy, a.s.	www.ceskedrahy.cz
6298	V	ČD, a.s. - Olomouc hl. n.	Olomouc hl.n.	Olomouc	České dráhy, a.s.	www.ceskedrahy.cz
6299	V	ČD, a.s. - CHV Olomouc	Olomouc hl.n.	Olomouc	České dráhy, a.s.	www.ceskedrahy.cz

1	2	3	4	5	6	7
6300	V	ČEZ, a.s., Rozvodný závod Přerov - sklad	Přerov	Olomouc	SLEZSKOMORAVSKÁ DRÁHA a.s.	www.slezskomoravskad raha.cz
6301	V	SVOR Skrochovice	Skrochovice	Ostrava	Petr Šrůtek s.r.o.	petr.srutek@seznam.cz
6302	V	ČD, a.s. - Valašské Meziříčí	Valašské Meziříčí	Valašské Meziříčí	České dráhy, a.s.	www.ceskedrahy.cz
6303	V	ČD, a.s. - Suchdol nad Odrou	Suchdol nad Odrou	Ostrava	České dráhy, a.s.	www.ceskedrahy.cz
6304	V	ČD, a.s. - Krnov	Krnov	Ostrava	České dráhy, a.s.	www.ceskedrahy.cz
6305	V	RSM Olomouc, ŽST Krnov	Krnov	Ostrava	České dráhy, a.s.	www.ceskedrahy.cz
6306	V	ČD, a.s. - Frýdek - Místek	Frýdek-Místek	Český Těšín	České dráhy, a.s.	www.ceskedrahy.cz
6307	V	ČD, a.s. - Opava	Opava-východ	Ostrava	České dráhy, a.s.	www.ceskedrahy.cz
6309	V	Vlečka NM LOKO - Litovel předměstí	Litovel předměstí	Olomouc	Rabbit Rail s.r.o.	www.rabrail.cz
6310	V	ČD, a.s. - Ostrava hl.n.	Ostrava hl.n.	Ostrava	České dráhy, a.s.	www.ceskedrahy.cz
6311	V	ČD, a.s. - CHV Valašské Meziříčí	Valašské Meziříčí	Valašské Meziříčí	České dráhy, a.s.	www.ceskedrahy.cz
6313	V	Bohumín terminál	Bohumín - Vrbice	Český Těšín	ČD Cargo, a.s.	www.cdcargo.cz
6314	V	Vlečka Vsetín	Vsetín	Valašské Meziříčí	Správa železnic, státní organizace	www.spravazeleznic.cz
6314	V	Vlečka Vsetín	Vsetín	Valašské Meziříčí	"STENO, v.o.s." - stavební a inženýrská činnost v kolejové dopravě	www.stenovos.cz
6316	V	TERMINÁL OSTRAVA MOŠNOV OAMP	Sedlnice	Ostrava	Terminál Mošnov, a.s.	www.innofreight.com
6903	V	SSHR Praha	Olomouc hl.n.	Olomouc	Česká republika - Správa státních hmotných rezerv	www.sshr.cz
6904	V	MORSEVA Olomouc	Olomouc hl.n.	Olomouc	MORSEVA, spol. s r.o.	www.morseva.cz
6903-6192	V	SSHR Praha - SOLNÉ MLÝNY Olomouc	Olomouc hl.n.	Olomouc	OLSPED, s.r.o.	www.www.olsped.cz
	C	Bohumín (1) - (OHV+OPJ+STP)	Bohumín	Český Těšín	České dráhy, a.s.	www.ceskedrahy.cz
	C	Bohumín (2) - (THÚ)	Bohumín	Český Těšín	České dráhy, a.s.	www.ceskedrahy.cz
	C	Bohumín (3) - seřadovací koleje	Bohumín	Český Těšín	České dráhy, a.s.	www.ceskedrahy.cz
	C	ŽST Bohumín-THÚ - Manipulační kolej č. 25, dopravní kolej č. 27 a spojovací kolej č. 95	Bohumín	Český Těšín	České dráhy, a.s.	www.ceskedrahy.cz
731 00	M	Místní dráha Čejč - Uhřice u Kyjova	Čejč	Břeclav	Railway Capital a.s.	www.railwaycapital.cz
	M	Nové Údolí - státní hranice/PJD	Červený Kříž - Nové Údolí	České Budějovice	Dr. ZENKL s.r.o.	www.drzenkl.cz
475 00	R	Regionální dráha Česká Kamenice - Kamenický Šenov	Česká Kamenice	Děčín	KŽC Doprava, s.r.o.	www.kzc.cz
	Z	Zkušební dráha CZ LOKO Česká Třebová	Česká Třebová	Česká Třebová	CZ Logistics, s.r.o.	www.czlog.cz
408 00	R	Regionální dráha Čížkovice - Obrnice	Čížkovice, Obrnice	Ústí nad Labem, Most	AŽD Praha s.r.o.	www.azd.cz
	C	Kolej ČD, a.s. - Děčín hl.n. (1)	Děčín hl.n.	Děčín	České dráhy, a.s.	www.ceskedrahy.cz

1	2	3	4	5	6	7
	C	Kolejiště ČD, a.s. - Děčín (2)	Děčín hl.n.	Děčín	České dráhy, a.s.	www.ceskedrahy.cz
	C	Kolejiště ČD, a.s. - Děčín (3)	Děčín hl.n.	Děčín	České dráhy, a.s.	www.ceskedrahy.cz
735 00	M	Místní dráha Hrušovany nad Jevišovkou - Hevlín	Hrušovany nad Jevišovkou - Šanov	Břeclav	Railway Capital a.s.	www.railwaycapital.cz
647 00	R	Jindřichův Hradec – Nová Bystřice, Jindřichův Hradec - Obrataň	Jindřichův Hradec	Tábor	Jindřichohradecké místní dráhy, a.s.	www.jhmd.cz
646 00	R	Regionální dráha Dolní Bousov - Kopidlno	Kopidlno, Dolní Bousov	Liberec	AŽD Praha s.r.o.	www.azd.cz
306 00	C	ČD, a.s. - Praha jih	Praha-Vršovice	Praha hl.n.	České dráhy, a.s.	www.ceskedrahy.cz
788 00	R	Šumperk - Petrov nad Desnou - Sobotín/ a Petrov nad Desnou - Kouty nad Desnou	Šumperk	Olomouc	SART - stavby a rekonstrukce a.s.	www.sart.cz
	Z	Železniční zkušební okruh Cerhenice	Velim	Kolín	Výzkumný Ústav Železniční, a.s.	www.cdvuz.cz

Annex "I"

Profile of the clearance Z-GB, Z-GC, Z-G2 and Z-GCZ3 and free walkable and manipulation space

1. Profile of the clearance Z-GB and free walkable and manipulation space (applies to straight track and curve with the radius greater than 250 m)

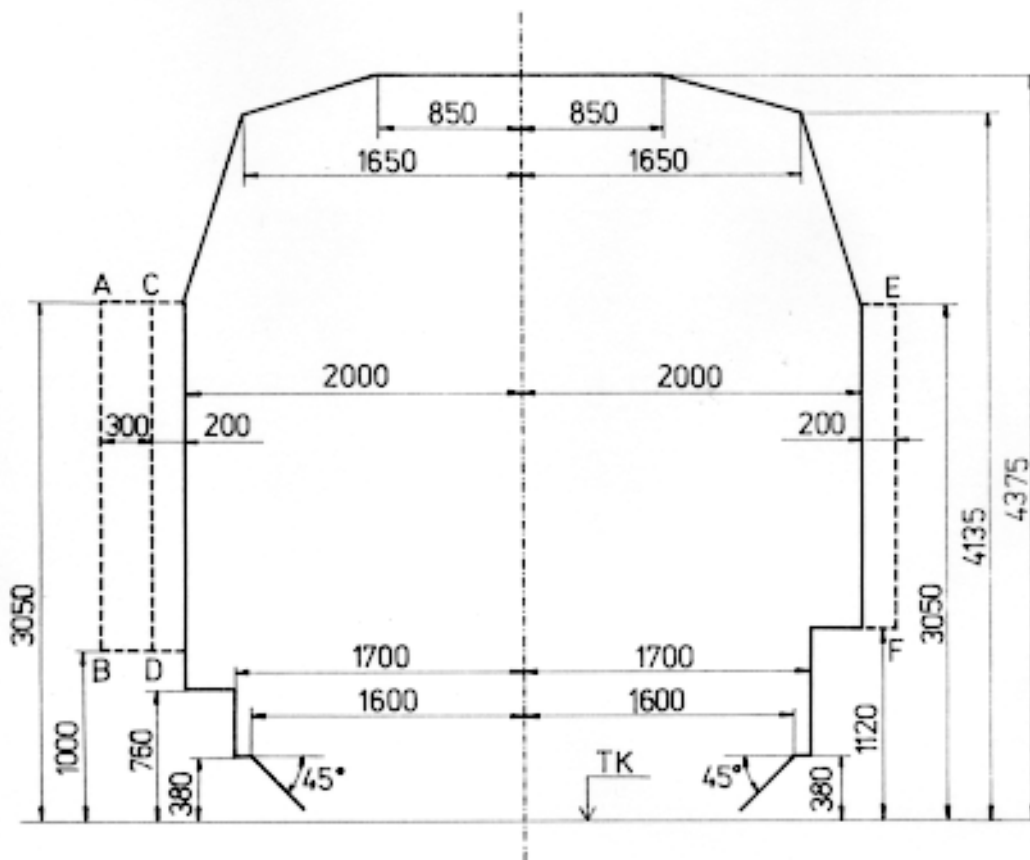

In figure:

Left side applies to

- track rails (in railway stops as well),
- main rails in stations and turnouts,
- transport rails for passenger trains,
- lateral free space

Right side applies to

- other rails in stations and turnouts,
- lateral free space,

2. Profile of the clearance Z-GC and free walkable and manipulation space (applies to straight track and curve with the radius greater than 250 m)

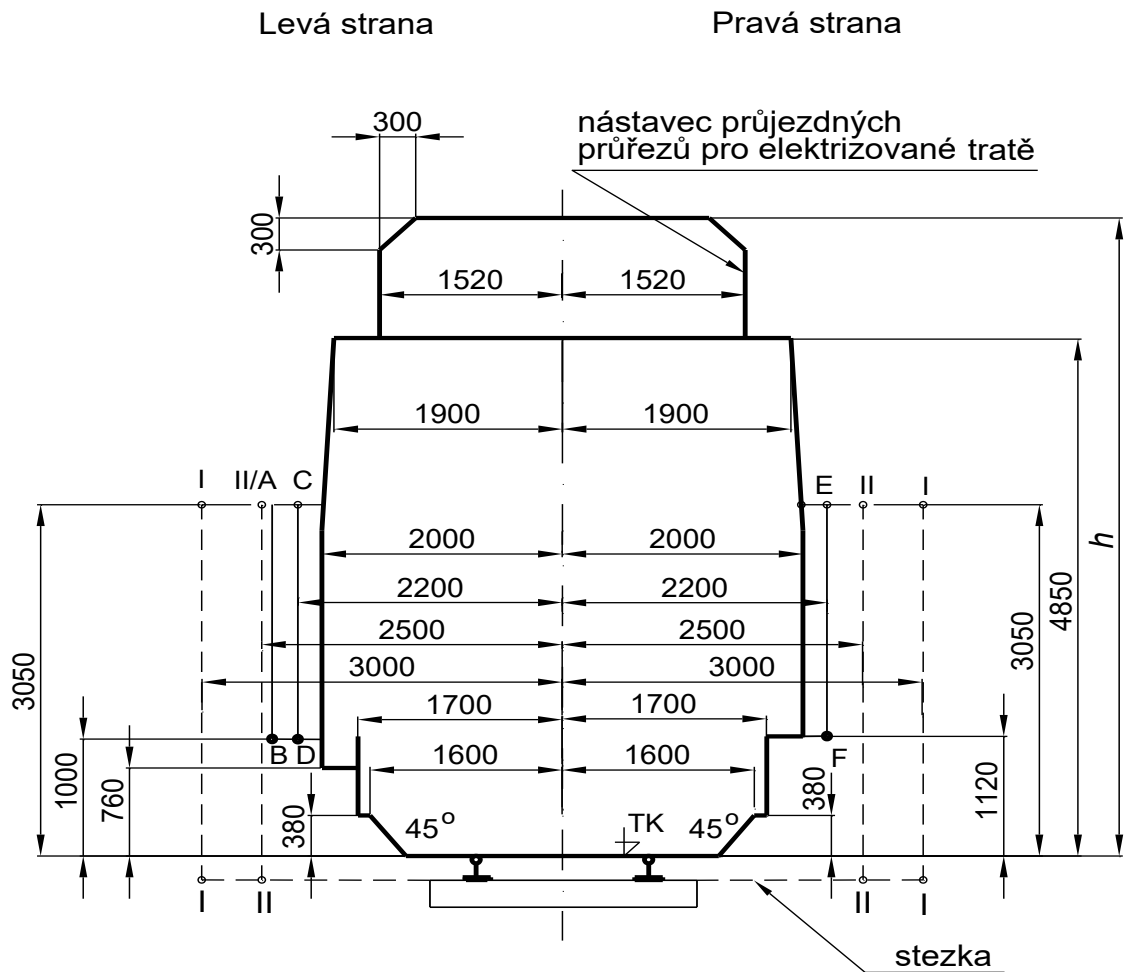

In Fig. 1

Left side applies - track rails (in railway stops as well),
to

- main rails in stations and turnouts,,
- transport rails for passenger trains,
- lateral free space

A - B to equipment on the outer side of the outer rail and constructions,
C - D to equipment between rails,

Right side applies - other rails in stations and turnouts,
to

- lateral free space,
- . E - F for all constructions and equipment.

I - I free walkable and manipulation space (basic),

II - II free walkable and manipulation space (narrowed),

h - height of the extension of the clearance for electrified tracks.

3. Profile of the clearance Z-G2 and free walkable and manipulation space (applies to straight rail and curve with the radius greater than or equal to 250 m)

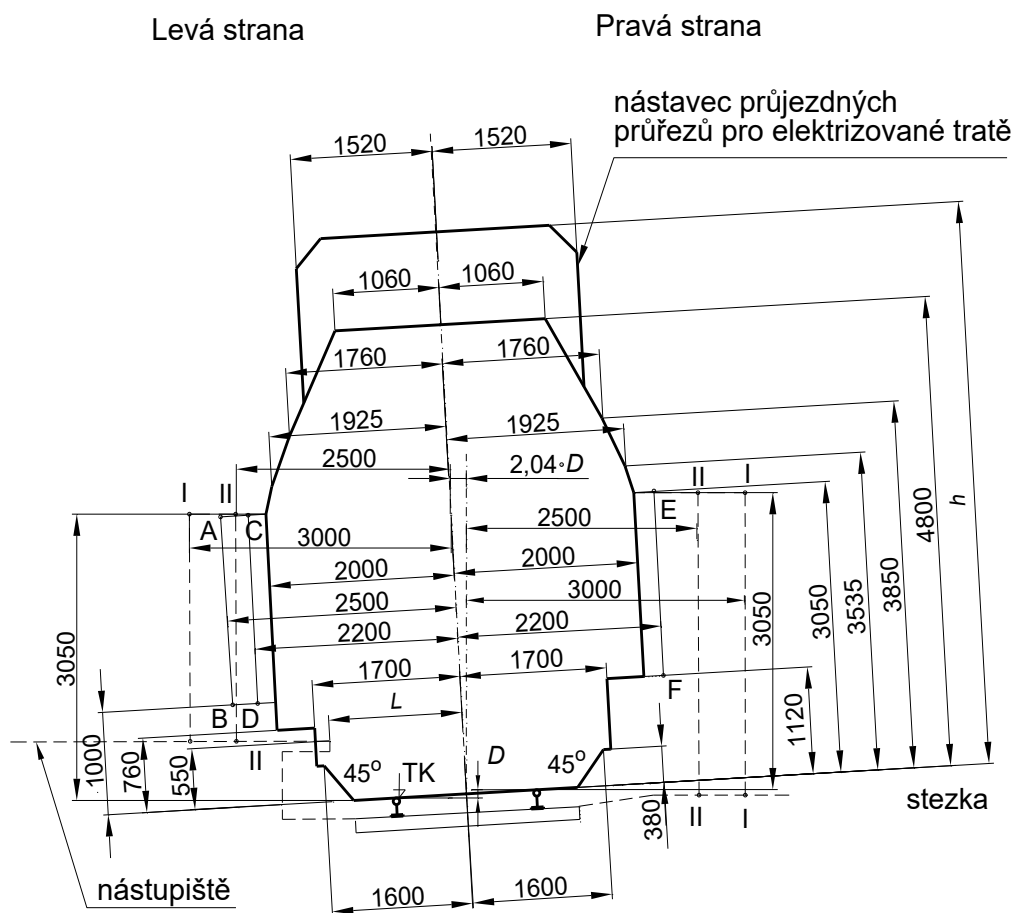

In Fig. 2:

Left side applies to

- track rails (in railway stops as well)
- main rails in stations and turnouts,
- transport rails for passenger trains,
- lateral free space

A - B to equipment on the outer side of the outer rail and constructions,
C - D to equipment between rails,

Right side applies to

- other rails in stations and turnouts,
- lateral free space,
- E - F for all constructions and equipment.,

I - I free walkable and manipulation space (basic),

II - II free walkable and manipulation space (narrowed),

L - distance of the platform edge with the height of 550 mm above TK (ČSN 73 4959),

h - height of the extension of the clearance for electrified tracks.

4. Profile of the clearance Z-GCZ3 and free walkable and manipulation space (applies to straight rail and curve with the radius greater than or equal to 250 m)

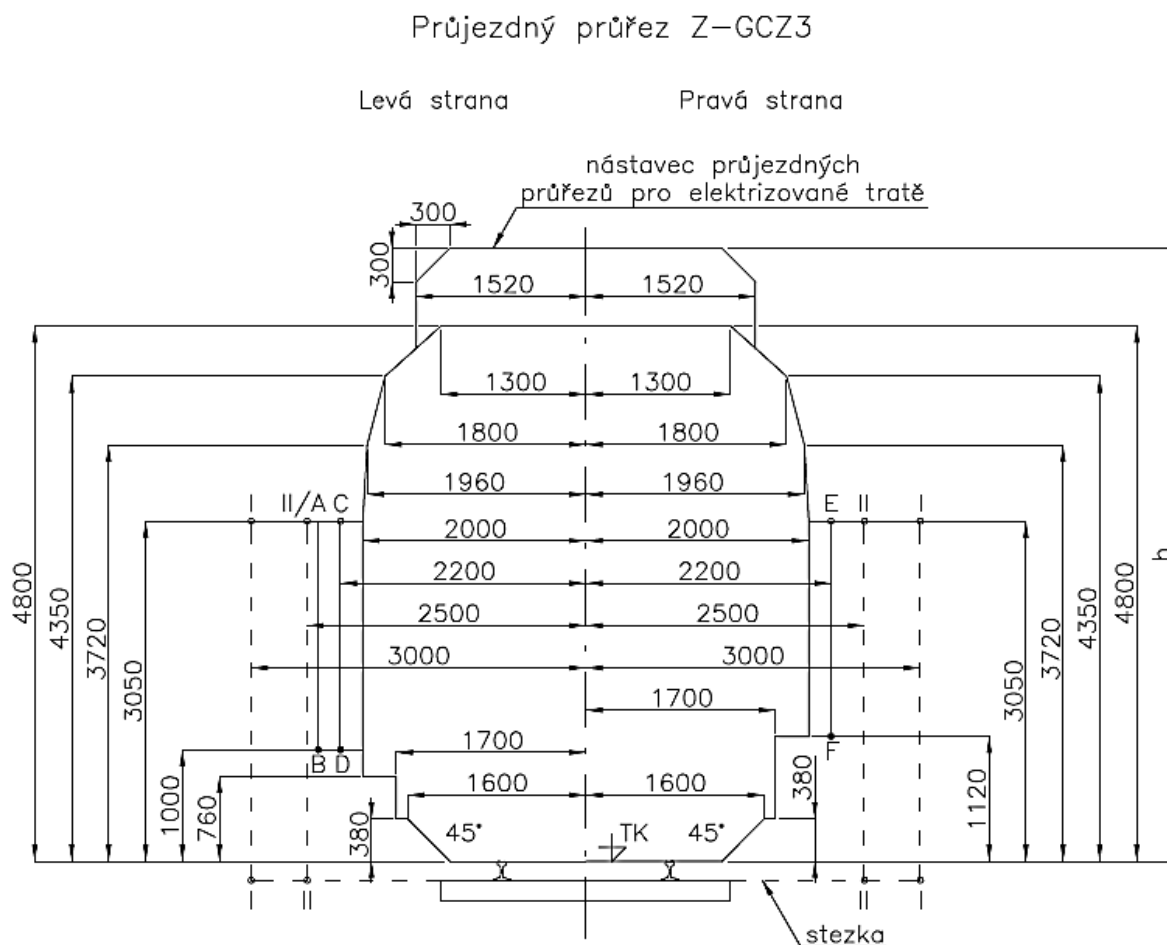

In Fig. 3:

Left side applies to

- track rails (in railway stops as well),
- main rails in stations and turnouts,
- transport rails for passenger trains,
- lateral free space

A - B to equipment on the outer side of the outer rail and constructions,
C - D to equipment between rails,

Right side applies to

- other rails in stations and turnouts,
- lateral free space,
- E - F for all constructions and equipment.

I - I free walkable and manipulation space (basic),

II - II free walkable and manipulation space (narrowed),

h - height of the extension of the clearance for electrified tracks

TK - top of rail string

Annex "J"

Devices for diagnosing defects of rolling stock vehicles

An integral part of the Správa železnic infrastructure is a device for diagnosing defects of rolling stock vehicles, which include hot roller indicators of bearings (IHL), hot tire and brake indicators (IHO), indicators of incorrect driving (INJ) and equipment for the monitoring of electric vehicle collectors (PMS). Devices diagnosing defects of rolling stock vehicles are set up to protect the railway infrastructure and ensure the safe operation of the track and rail transport.

The basic objectives of these systems are:

- Increasing traffic safety by disposing of a damaged vehicle using IHL and IHO where the IHL indicator is a part of the diagnostic system indicating the temperature of the axle pivots, and the IHO is part of the torch temperature wheels, brake blocks and disc brakes,
- ensuring the protection of the railway superstructure and other parts of the railway infrastructure, especially in the upgraded sections, from the impact of wheelchair buggies in the use of INJ, where the INJ is part of a diagnosis indicating wheel defects, wheel defects and other defects causing damage to the rails,
- Enhance the safety of the train running through the tunnel and meet the requirements for fire safety of railway tunnels by IHL + IHO,
- ensuring the protection of the overhead contact line and other components of the railway infrastructure from possible damage caused by improperly set or damaged electric vehicle trawlers (in particular damage to the lining of the tracks and improperly adjusted compressive force),
- compliance with the conditions of interoperability of the rail network of the Czech Republic included in the trans-European conventional rail system, IHL, IHO, INJ and PMS railway infrastructure equipment according to Directive 2008/57 / EC of the European Parliament and of the Council 2016 / 797) on the interoperability of the rail system in the Community,
- integration of installed IHL, IHO, INJ and PMS diagnostics into the on-board diagnostic information system for on-board vehicles.

Based on the above, the Správa železnic reserves the right to stop a train on which a fault has been indicated by the diagnostic device.

The rolling stock diagnosis equipment of the Czech Republic (IHL, IHO, INJ) is positioned so that it creates a connected system of indicators in a cascade arrangement at a distance according to the recommendation of UIC.

A list of devices for fault diagnostics of moving vehicles

Table Legend:

Number according to Directive no. 36 – Number of device for fault diagnostics of moving vehicles, according to Annexes 2 and 3 of the Directive SŽDC no. 36

Number of line according to TTP – Number of tracks under the TTP. According to this column table is sorted.

Line section – Specific line section where the device is located

km – Kilometre position location of device

Track – Number of the track with the location of device for the lines with two or more tracks. For single-track line cell is empty.

Comment – Another related comment for a particular device. For example, the name of the building within which the device will be built.

A list of devices for fault diagnostics of moving vehicles

Number according to Directive no. 36	Number of line according to TTP	Line section	km	Track	Comment
3.2	301A	Návsí - Bystřice	303,130	2	
2.8	301B	Petrovice u Karviné - odb. Závada	289,370	2	
2.1	305B	Jistebník - Studénka	250,337	2	
2.2	305B	Suchdol nad Odrou - Polom	228,280	1	
2.4	305B	Lipník nad Bečvou - Prosenice	197,355	2	
2.3	136A	Říkovice - Hulín	173,000	2	
280.1	308	Horní Lideč - Valašská Polanka	21,786	2	
3.1	309A	Grygov - Brodek u Přerova	196,130	1	
3.3	309A	Krasíkov - Hoštejn	29,090	1	
3.4	309A	Lukavice na Moravě - Mohelnice	49,760	2	
3.6	309A	Rudoltice v Čechách - Třebovice v Čechách	10,300	2	
300.2	315A	Vyškov - Ivanovice na Hané	51,556		
2.5	316A	Nedakonice - Moravský Písek	126,915	1	
2.6	316A	Lužice - Moravská Nová Ves	96,608	2	
1.1	320A	Podivín - Zaječí	97,041	1	
1.20	320A	Lanžhot st.hr. - Lanžhot	9,708	2	
1.2	320A	Hrušovany u Brna - Rajhrad	128,780	2	
2.7	320D	Břeclav st.hr. - Břeclav	78,230	2	
230.1	324	Světlá nad Sázavou - Okrouhlice	234,760	1	
230.2	324	Čáslav - Kutná Hora	283,810	2	
250.1	324	Ostrov nad Oslavou - Sklené nad Oslavou	74,138	1	
250.2	324	Říkonín - Vlkov u Tišnova	46,467	2	
250.3	324	Kuřim - Brno-Královo Pole	15,300	1	
250.4	324	Pohled - Přibyslav	104,417	2	
1.3	326A	Březová nad Svitavou - Letovice	207,842	1	
1.4	326A	Blansko - Rájec Jestřebí	181,401	2	
1.12, 1.14	501A	Český Brod - Úvaly	384,420	2, 0	
1.5	501A	Ústí nad Orlicí - Česká Třebová	254,670	1	
1.7	501A	Přelouč - Pardubice	313,224	1	
1.8	501A	Pardubice - Kostěnice	299,249	2	
1.9	501A	Poříčany - Pečky	368,655	1	
1.10	501A	Záboří nad Labem - Kolín	339,408	2	
1.6	501B	Svitavy - Opatov	231,813	2	
231.1	502A	Kostomlaty nad Labem - Nymburk	326,505	1	
072.1	503A	Mělník - Všetaty	370,250	1	
072.2	503A	Stará Boleslav - Dřísy	352,320	2	
072.4	503A	Velké Žernoseky - Sebzín	417,590	2	
130.1	504A	Chabařovice - Ústí nad Labem západ	9,250	1	
	504C	Úpořiny - Řehlovice	10,508	1	
130.2	504A	Bílina - Most	35,606	2	
020.1	505A	Káranice - Dobřenice	9,850		
024.1	512B	Lichkov st.hr. - Lichkov	112,560		
4.5	519A	Čerčany - Senohraby	149,150	1	
4.8	519A	Praha-Uhřetěves - Praha Hostivař	174,293	2	

Number according to Directive no. 36	Number of line according to TTP	Line section	km	Track	Comment
1.13	527A	Dolní Zálezly - Prackovice nad Labem	506,510	1	
1.16	527A	Roztoky u Prahy - Libčice nad Vltavou	428,710	2	
1.18	527A	Hrobce - Bohušovice nad Ohří	485,370	2	
1.11	527A	Nelahozeves - Vraňany	449,130	1	
140.1,140.2	533A	Karlovy Vary - Chodov	193,590	1,2	
1.15	544A	Děčín st.hr. - Dolní Žleb	11,800	1	
4.1	704	České Budějovice - Hluboká nad Vltavou-Zámostí	5,000		
4.3	704	Sudoměřice - Tábor	93,817	1	
4.4	704	Roudná - Planá nad Lužnicí	72,315	2	
4.6	704	Olbramovice - Benešov u Prahy	120,650	2	
4.2	706A	Včelná - Kamenný Újezd u Českých Budějovic	109,570		
190.1	709B	Zliv - Hluboká nad Vltavou	225,770		
190.2	709B	Katovice - Strakonice	278,000		
190.4	709B	Starý Plzenec - Nezvěstice	337,043		
183.1	711	Dobřany - Plzeň Valcha	85,500		
180.1	712A	Nýřany - Vejprnice	121,600		
3.8, 3.5	713A	Hořovice - Kařízek	62,891	1, 2	
3.10	713A	Plzeň Doubavka - Plzeň	101,342	2	
3.7	720A	Pňovany - Kozolupy	362,295		
3.12	720A	Planá u Mariánských Lázní - Chodová Planá	414,490		

Annex "K"

Draft sample arrangement on penalty payments for disruption of rail transport and non-using allocated railway infrastructure capacity

This Annex covers the model draft agreement on penalty payments for disruption of rail transport and non-using allocated railway infrastructure capacity.

Part A

Draft sample arrangement on the regional network operated by PKP CARGO INTERNATIONAL, a.s.

System odměňování výkonu

1. Smluvní strany se zavazují dodržovat systém odměňování výkonu stanovený provozovatelem v platném Prohlášení o dráze, podmínky pro uplatnění sankcí z tohoto systému a výši těchto sankcí.
2. Smluvní strany jsou povinny předem vzájemně projednat každé uplatnění sankce ze systému odměňování výkonu.
3. Smluvní strany se dohodly, že v případě vzniku sporu ve věci uplatnění sankce ze systému odměňování výkonu se nejdříve pokusí nalézt shodu smírnou cestou pomocí mimosoudního řešení sporu před nezávislým subjektem. Provozovatel dráhy zajistil pro případ mimosoudního řešení sporu ve věci uplatnění sankce ze systému odměňování výkonu jako nezávislý subjekt společnost **PDV RAILWAY a.s.** se sídlem Blahoslavova 937/62, Ústí nad Labem, PSČ 400 01 (IČ 227 92 597). V případě, že by měl dopravce pochybnosti o nezávislosti výše uvedeného provozovatelem zajištěného subjektu, je dopravce oprávněn zajistit jiný subjektu pro řešení předmětného sporu, který splňuje podmínku nezávislosti.

Smluvní strana, která námitku ve věci uplatnění sankce ze systému odměňování výkonu vznesne, písemně požádá druhou smluvní stranu o vyřešení sporu v rámci mimosoudního jednání před nezávislým subjektem. Nezávislý subjekt je následně neprodleně požádán o vyřešení sporu provozovatelem dráhy, v případě zajištění daného nezávislého subjektu provozovatelem dráhy, popř. dopravcem, v případě zajištění daného subjektu tímto dopravcem. Řešení sporu je písemné, odpověď musí být odeslána nejpozději 10 pracovních dnů po doručení žádosti o vyřešení sporu nezávislému subjektu.

Pokud kterákoliv ze stran nebude s rozhodnutím nezávislého subjektu souhlasit, nebo se na uplatnění sankce nejpozději do 10 pracovních dnů po doručení vyrozumění o sporu nezávislému subjektu neshodnou, nebo marně uplyne lhůta pro doručení rozhodnutí o sporu vydaného příslušným nezávislým subjektem, může být spor jednou ze smluvních stran předložen k řešení příslušnému soudu České republiky.

4. Projednané sankce dle systému odměňování výkonu fakturují smluvní strany měsíčně. Příslušná smluvní strana uhradí fakturovanou částku na účet druhé smluvní strany s použitím

čísla faktury jako variabilního symbolu. Splatnost faktury je 30 kalendářních dnů od jejího doručení.

5. Žádná ze smluvních stran není oprávněna provést úhradu sankcí ze systému odměňování výkonu formou jednostranného zápočtu.

Part B

Draft sample arrangement on the regional network operated by PDV RAILWAY a.s.

I. Systém odměňování výkonu

- Smluvní strany se zavazují dodržovat systém odměňování výkonu stanovený provozovatelem v platném Prohlášení o dráze, podmínky pro uplatnění sankcí z tohoto systému a výši těchto sankcí.
- Smluvní strany jsou povinny předem vzájemně projednat každé uplatnění sankce ze systému odměňování výkonu.
- Smluvní strany se dohodly, že v případě vzniku sporu ve věci uplatnění sankce za systému odměňování se pokusí nejdříve nalézt shodu smírnou cestou pomocí mimosoudního řešení sporu před nezávislým subjektem. Pro případ mimosoudního řešení sporu ve věci uplatnění sankce ze systému odměňování výkonu zajistil provozovatel dráhy jako nezávislý subjekt společnost PKP CARGO INTERNATIONAL, a.s. se sídlem Hornopolní 3314/38, Ostrava, Moravská Ostrava, PSČ 702 62 (IČ 476 75 977). V případě, že by měl dopravce pochybnosti o nezávislosti výše uvedeného provozovatelem dráhy zajištěného subjektu, je pak dopravce oprávněn zajistit jiný subjekt pro řešení předmětného sporu, který splňuje podmínky nezávislosti. Smluvní strana, která námitku ve věci uplatnění sankce ze systému odměňování výkonů vznesla, písemně požádá druhou smluvní stranu o vyřešení sporu v rámci mimosoudního jednání před nezávislým subjektem. Nezávislý subjekt řeší spor neprodleně a vyřešení sporu je písemné, odpověď musí být odeslána nejpozději 10 pracovních dnů po prokazatelném obdržení žádosti o vyřešení sporu k nezávislému subjektu. V případě, že kterákoliv ze stran nebude s rozhodnutím nezávislého subjektu souhlasit, nebo se na uplatnění sankce nejpozději do 10 pracovních dnů po doručení vyznění o sporu nezávislému subjektu neshodnou, nebo marně uplyne lhůta pro doručení rozhodnutí o sporu vydaného příslušným nezávislým subjektem, může být spor jednou ze smluvních stran předložen k řešení soudu České republiky.
- Projednané sankce dle systému odměňování výkonu fakturují smluvní strany měsíčně. Příslušná smluvní strana uhradí fakturovanou částku na účet druhé smluvní strany s použitím čísla faktury jako variabilního symbolu. Splatnost faktury je 30 kalendářních dnů od jejího doručení.
- Žádná ze smluvních stran není oprávněna provést úhradu sankcí ze systému odměňování výkonu formou jednostranného zápočtu.

Part C

Draft sample arrangement on the regional network operated by Správa železniční dopravní cesty, státní organizace

The contract on the operation of railway transport on the national railway and regional railways, concluded between Správa železnic and the RU, contains the following arrangements:

Článek 16

Sankce za narušení provozování drážní dopravy

1. Smluvní strany se zavazují dodržovat systém sankcí za narušení provozování drážní dopravy stanovený provozovatelem v platném prohlášení o dráze, podmínky pro uplatnění sankcí z tohoto systému a výši těchto sankcí. Smluvní strany jsou povinny každé uplatnění sankce z tohoto systému předem vzájemně projednat.
2. Smluvní strany si předávají podrobné informace o narušení provozování drážní dopravy prostřednictvím SPIS. Do sankčního režimu jsou zahrnuty vlaky uvedené v platném prohlášení o dráze. Vyhodnocování a kalkulace narušení provozování drážní dopravy probíhá ve dvou fázích:

A. Vyhodnocování jednotlivých jízd dopravce, výpočet výše sankce:

- a. Každý vlak daného dopravce zahrnutý do sankčního režimu je vyhodnocován samostatně.
- b. U každého vlaku se sečtou zvlášť přírůstky zpoždění vzniklé po dobu jízdy vlaku z odpovědnosti provozovatele a zvlášť přírůstky zpoždění vzniklé po dobu jízdy vlaku z odpovědnosti dopravce. Přírůstky zpoždění vzniklé po dobu jízdy vlaku z ostatních příčin se nezohledňují.
- c. Výše sankce se vypočítá jako sazba za minutu zpoždění vynásobená kladným rozdílem mezi sumou přírůstků zpoždění vzniklých po dobu jízdy vlaku z odpovědnosti jedné smluvní strany a sumou přírůstků zpoždění vzniklých po dobu jízdy vlaku z odpovědnosti druhé smluvní strany.
- d. Kalkulačním obdobím je kalendářní měsíc. Účetním obdobím je jeden kalendářní rok.

B. Vyhodnocování všech jízd dopravce, stanovení míry odpovědnosti:

- a. Počet vlaků dopravce zahrnutých v sankčním režimu je porovnán s celkovým počtem vlaků dopravce (tj. počtem vlaků celkem z informačního systému KAPO pro účely stanovení ceny za použití dráhy jízdou vlaku pro daný kalendářní měsíc).
- b. Pokud je počet vlaků zahrnutých v sankčním režimu vyšší nebo roven 20% z celkového počtu vlaků, uhradí smluvní strana, která je odpovědná za 60 a více % minut všech přírůstků zpoždění všech vlaků zahrnutých do sankčního režimu v daném kalendářním měsíci, druhé smluvní straně sankci. Pro uplatnění sankce musí být splněny obě limitující podmínky.
- c. Kalkulačním obdobím je kalendářní měsíc. Účetním obdobím je jeden kalendářní rok.

Sazby sankcí dle předcházejících bodů A. a B. jsou uvedeny v platném prohlášení o dráze.

3. Smluvní strany se dohodly, že v případě vzniku sporu ve věci uplatnění sankce za narušení provozování drážní dopravy se nejdříve pokusí nalézt shodu smírnou cestou. Sporné případy jsou provozovatelem průběžně předávány arbitrovi uvedenému v platném prohlášení o dráze. Lhůta pro řešení sporných případů arbitrem je 10 pracovních dnů. Podrobný technický postup řešení sporných případů je uveden v platném prohlášení o dráze.
4. Provozovatel uhradí arbitrovi za každý rozhodnutý sporný případ sankci dle platného prohlášení o dráze. V případě že je sporný případ rozhodnutý arbitrem ve prospěch provozovatele, uhradí tutéž sankci dopravce provozovateli. Pokud rozhodnutí arbitra není ve prospěch dopravce nebo provozovatele jednoznačné, uhradí dopravce provozovateli jen 1/2 této sankce. Pokud arbitr z vlastní viny sporný případ ve lhůtě 10 pracovních dnů nerozhodne, arbitr uhradí provozovateli sankci ve výši dvojnásobku sankce dle platného prohlášení o dráze a provozovatel uhradí 1/2 z této částky dopravci. Kalkulačním obdobím je kalendářní měsíc.
5. Pokud arbitr sporný případ ve lhůtě 10 pracovních dnů nerozhodne bez vlastního zavinění, žádná sankce se nehradí. Arbitr je však v takovém případě povinen doložit provozovateli i dopravci důvody, které mu znemožnily vydat rozhodnutí.

6. Pokud kterákoliv ze smluvních stran nebude s rozhodnutím arbitra souhlasit, nebo se smluvní strany na uplatnění sankce nejpozději do 10 pracovních dnů po doručení vyrozumění o sporu arbitrovi neshodnou, nebo marně uplyne lhůta pro doručení rozhodnutí o sporu vydaného příslušným arbitrem, může být spor jednou ze smluvních stran předložen k řešení příslušnému soudu České republiky.
7. Vzájemně projednané sankční částky vyplývající ze sankčního systému fakturují smluvní strany do 15. dne čtvrtého kalendářního měsíce po skončení kalendářního měsíce, ve kterém důvod k uplatnění sankce vznikl. Daňový doklad zahrnuje celkovou výslednou cenu za všechny odsouhlasené sankce v příslušném kalendářním měsíci. Příslušná smluvní strana uhradí fakturovanou částku na účet druhé smluvní strany s použitím variabilního symbolu uvedeného na daňovém dokladu. Splatnost daňového dokladu je 30 kalendářních dnů od jeho vystavení. V případě prodlení s úhradou fakturované částky je příslušná smluvní strana povinna uhradit kromě dlužné částky i úrok z prodlení ve výši dané platnou právní úpravou.
8. Žádná ze smluvních stran není oprávněna provést úhradu sankcí za narušení provozování drážní dopravy formou jednostranného zápočtu.

Annex "L"

Common Template for Service Facilities

Czech version

Článek 5 odstavec 2 Prováděcího nařízení Komise (EU) 2017/2177 ze dne 22. listopadu 2017 o přístupu k zařízením služeb a k službám souvisejícím s železniční dopravou říká, že provozovatelé infrastruktury poskytnou společný vzor, jenž mohou provozovatelé zařízení služeb používat pro předložení informací a který do 30. června 2018 vypracuje železniční odvětví ve spolupráci s regulačními subjekty. Vzor bude podle potřeby revidován a aktualizován.

Tento společný vzor pro popis zařízení služeb je výsledkem řešení navrženého asociací RNE a IRG-Rail ve spolupráci a železničním sektorem a je zaměřen na podporu provozovatelů zařízení služeb při vytváření popisu zařízení služeb v souladu s požadavky Prováděcího nařízení Komise (EU) 2017/2177. Provozovatelé zařízení služeb mohou použít tento společný vzor pro popis zařízení služeb nebo mohou vytvořit svůj vlastní vzor pro publikaci informace o zařízení služeb na svých webových stránkách nebo na společném webovém portálu v souladu s požadavky platné legislativy.

Pro použití tohoto společného vzoru pro popis zařízení služeb platí následující vysvětlivky:

- Uvedení údajů psaných standardním písmem je vždy povinné podle článku 4 odst. 2 Prováděcího nařízení Komise (EU) 2017/2177;
- Uvedení údajů psaných kurzívou je povinné podle Prováděcího nařízení Komise (EU) 2017/2177;
- Písmena v závorkách odkazují na příslušné odstavce článku 4 nebo jiná ustanovení Prováděcího nařízení Komise (EU) 2017/2177;
- Na uvedení údajů označených * mohou být uděleny výjimky regulačními úřady;
- Všechny ostatní informace jsou nepovinné.

Společný vzor pro popis zařízení služeb

Číslo kapitoly	Nadpis	Implementační příručka	Doporučený text
	ZÁZNAM O ZMĚNÁCH	Zde se uvedou všechny přechozí změny tohoto popisu zařízení včetně krátkého popisu obsahu těchto změn	
	OBSAH		
1	Obecné informace		
1.1	Úvod	<ul style="list-style-type: none"> Vysvětlíte účel tohoto dokumentu Uveďte název a typ zařízení služeb podle přílohy II. Směrnice 2012/34 Uveďte stručnou prezentaci zařízení služeb Uveďte, kde je dokument zveřejněn 	<p>[Provozovatel zařízení služeb] vytvořil tento popis zařízení služeb v souladu s požadavky Prováděcího nařízení Komise (EU) 2017/2177.</p> <p>[název zařízení služeb] je (vyber jedno nebo více kategorií od a) po i) z přílohy II Směrnice 2012/34)</p> <p>[Provozovatel zařízení služeb] je společnost, která se věnuje (uveďte stručnou prezentaci provozovatele zařízení služeb).</p> <p>Tento popis zařízení služeb je zveřejněn na www.xxxxxx.xx</p>
1.2	Provozovatel zařízení služeb	Jméno, adresa a kontaktní údaje všech provozovatelů zařízení služeb (b) Pokud je zařízení služeb provozováno více jak jedním provozovatelem nebo kde jsou služby poskytovány více jak jedním poskytovatelem musí být uvedeno, zda je nutno podat samostatné žádosti o využití zařízení služeb nebo poskytnutí služeb (g)*	
1.3	Platnost a změny	<ul style="list-style-type: none"> Uveďte datum platnosti dokumentu Popište, jak je dokument aktualizován 	<p><i>Příklady:</i></p> <ul style="list-style-type: none"> <i>Tento dokument je aktualizován jednou ročně v čase publikace prohlášení o dráze, pokud změny v jeho obsahu nevyžadují mimořádné aktualizace.</i> <i>Tento dokumenty je aktualizován každý rok dne XX.YY pokud změny jeho obsahu nevyžadují mimořádnou změnu.</i> <i>Tento dokument je aktualizován podle potřeby.</i>
2	Služby		
2.X	Název služby	<ul style="list-style-type: none"> Popis služeb souvisejících s železniční dopravou, které jsou poskytovány na zařízení služeb a jejich typ (doplňkové, pomocné) (d). viz také příloha II Směrnice 2012/34/EU <i>Alternativně je také možno uvést odkaz na webové stránky, kde jsou všechny relevantní informace publikovány</i> <p>X znamená počet poskytovaných služeb</p>	
3	Popis zařízení služeb		
3.1	Seznam všech lokalit	<ul style="list-style-type: none"> Pokud je to účelné, uveďte seznam všech lokalit kde jsou služby související s železniční dopravou poskytovány (a) <p>[Pozn.: Pokud je možné integrovat všechny informace z podkapitol 3.X do jedné tabulky uvnitř kapitoly 3.1 (každý řádek odpovídá jedné lokalitě a různé sloupce odkazující na "Umístění", "Otevírací hodiny", "Technické charakteristiky" a "Plánované změny v technických charakteristikách"), není zapotřebí zahrnutí podkapitol 3.X]</p>	<p>V případě, že zařízení služeb je jen v jedné lokalitě:</p> <ul style="list-style-type: none"> Toto zařízení služeb se vyskytuje jen v jedné lokalitě. <p>V případě složitých zařízení služeb, jejichž provozovatelé již zveřejnili informace, splňují požadavky Prováděcího nařízení Komise (EU) 2017/2177 se uvede::</p> <ul style="list-style-type: none"> Seznam lokalit je uveden na www.xxxxxxxxxx <p>Popis těchto lokalit je uveden na www.xxxxxxxx [v tomto případě kapitoly 3.2 až 3.X mohou být vynechány]</p>

Číslo kapitoly	Nadpis	Implementační příručka	Doporučený text
3.X	Název lokality X	<ul style="list-style-type: none"> X je zástupný symbol, takže kapitoly o každé lokalitě mohou být očíslovány konzistentně. <p>Pokud je zařízení služeb pouze v jedné lokalitě, číslování kapitoly bude ukončeno 3.2.4. Pokud je zařízení služeb ve dvou lokalitách, číslování kapitol skončí 3.3.4.</p>	
3.X.1	Lokalita	<ul style="list-style-type: none"> Popis lokality, kde je umístěno zařízení služeb 	<p>Příklady:</p> <ul style="list-style-type: none"> GPS souřadnice lokality Popis cesty k zařízení služeb Popis cesty po silnici Místo, kde je zařízení služeb napojeno na železniční síť, včetně názvu stanice pokud je napojeno ve stanici
3.X.2	Provozní doba	<ul style="list-style-type: none"> Provozní doba zařízení služeb v dané lokalitě 	<p>Příklady:</p> <ul style="list-style-type: none"> Provozní doba <ul style="list-style-type: none"> Pondělí – Pátek Sobota – Neděle Provozní doba o dnech pracovního volna <ul style="list-style-type: none"> Státní svátky Provozní doba jednotlivých služeb (a) <ul style="list-style-type: none"> Pondělí – Pátek Sobota – Neděle prázdninová otevírací doba státní svátky
3.X.3	Technické vybavení	<ul style="list-style-type: none"> Tam kde je to účelné se uvede technický popis zařízení služeb v dané lokalitě 	<p>Příklady:</p> <ul style="list-style-type: none"> Technické charakteristiky Soukromá dráha: Počet a délka kolejí (TEN-T parametry) Vlečky: Počet s délkou kolejí (TEN-T parametry) Koleje pro posun a sestavu vlaků: Počet a délka kolejí (TEN-T parametry) Technické zařízení pro nakládku a vykládku: Vybavení (jeřáby, rampy, zdvihací zařízení) Technické zařízení pro mytí a čištění Technické zařízení pro údržbu Skladovací plocha (m²)
3.X.4	Plánované změny technického vybavení	<ul style="list-style-type: none"> Informace o změnách technických charakteristik a dočasných kapacitních omezeních zařízení služeb, které by mohly mít významný dopad na provoz zařízení služeb, včetně plánovaných prací (I)* 	<p>Příklady:</p> <ul style="list-style-type: none"> Podrobnosti o oznámených investicích <ul style="list-style-type: none"> Seznam projektů Umístění Charakter projektu Datum zahájení a ukončení prací
4	Ceny		
4.1	Informace o cenách	<ul style="list-style-type: none"> informace o cenách za přístup k zařízením služeb a za využití každé služby související s železniční dopravou, která je v nich poskytována (m) 	
4.2	Informace o slevách	<ul style="list-style-type: none"> informace o zásadách systémů slev nabízených žadatelům při dodržení požadavků na obchodní tajemství (n)* 	
5	Podmínky přístupu		

Číslo kapitoly	Nadpis	Implementační příručka	Doporučený text
5.1	<i>Právní podmínky</i>	<ul style="list-style-type: none"> • <i>Informace o tom, zda je nutné uzavírat smlouvu, mít nějaké potvrzení nebo pojištění</i> • <i>Vzorové smlouvy o přístupu a obecné smluvní podmínky (přínejmenším v případech zařízení služeb provozovaných a služeb souvisejících s železniční dopravou poskytovaných provozovateli přímo nebo nepřímo ovládanými kontrolujícím subjektem) (i)*</i> 	
5.2	<i>Technické podmínky</i>	<ul style="list-style-type: none"> • <i>Tam kde je to vhodné se uvede popis technických podmínek, které musí splňovat drážní vozidla pro přístup k zařízení služeb</i> 	<i>Příklady:</i> <ul style="list-style-type: none"> • <i>Typ drážního vozidla</i> • <i>Maximální délka vlaku, rozchod, hmotnost</i>
5.3	Samoobslužný způsob využití služeb souvisejících s železniční dopravou	<ul style="list-style-type: none"> • možnost využití služeb souvisejících s železniční dopravou samoobslužným způsobem a podmínky, které pro ni platí (e)* 	
5.4	IT systémy	<ul style="list-style-type: none"> • informace o podmínkách používání IT systémů provozovatele, musí-li žadatelé tyto systémy používat, a pravidla týkající se ochrany citlivých a obchodních údajů (j)* 	
6	Přidělování kapacity		
6.1	Žádosti o přístup k zařízení služeb nebo o služby	<ul style="list-style-type: none"> • <i>Informace o postupech pro podání žádosti o přístup k zařízení služeb nebo ke službám poskytnutým v zařízení služeb nebo k obojímu, včetně lhůt pro podání žádostí a lhůt pro vyřízení těchto žádostí f)* a (článek 8)*</i> • <i>u zařízení služeb provozovaných více než jedním provozovatelem nebo v případě, že služby související s železniční dopravou jsou poskytovány více než jedním provozovatelem, musí být uvedeno, zda je třeba předložit samostatné žádosti o přístup k zařízením služeb a o tyto služby; g) *</i> • <i>informace o minimálním obsahu a formátu žádosti o přístup k zařízení služeb a ke službám souvisejícím se železniční dopravou nebo vzor pro takovou žádost (h) *</i> 	
6.2	Vyřízení žádosti	<ul style="list-style-type: none"> • <i>Popis vyřízení žádosti (Článek 9)*</i> • <i>Popis způsobu koordinace žádostí a regulačních opatření uvedených v článku 10 a prioritních kritérií uvedených v článku 11 (k)*</i> 	
6.3	Informace o dostupné kapacitě a dočasných omezeních kapacity	<ul style="list-style-type: none"> • <i>Informace o dočasných kapacitních omezeních zařízení služeb, které by mohly mít významný dopad na provoz zařízení služeb, včetně plánovaných prací (l)*</i> 	

English version

Article 5 (2) of Implementing Regulation 2017/217 states that 'Infrastructure managers shall provide a common template to be developed by the railway sector in cooperation with regulatory bodies by 30 June 2018 that operators of service facilities may use to submit the information.'

This Common Template for Service Facilities is the result of a solution developed by RNE and IRG-Rail in cooperation with the railway sector and is aimed at supporting the Service Facilities Operators (SFO) in producing the information documents according to the requisites of Implementing Regulation 2017/2177. SFOs can choose to adopt this common template or develop their own specific template, to be published on their own website or a common portal, as long as the legal requisites are met.

While using this template, the following legend is applicable (this segment is for the consideration of the editor only and should not be featured in the SF document):

Requirements in standard font are mandatory in any case according to Article 4 (2) IR 2017/2177

Requirements in italics are mandatory where applicable according to IR 2017/2177

Letters in brackets refer to the IR 2017/2177 applicable paragraphs of article 4 or other identified articles.

Exemptions may be granted by the Regulatory Bodies (RBs) on a case by case basis for requirements marked with *

All the rest of the information is optional.

Common Template for Service Facilities

Chapter number	Heading	Implementation guide	Suggested text
	VERSION CONTROL	All previous versions of this information should be identified, together with a short description of the changes	
	TABLE OF CONTENTS		
1	General Information		
1.1	Introduction	<ul style="list-style-type: none"> Explain the purpose of this document Identify the SF name and type according to Directive 2012/34 Annex II Give a brief presentation of the SF State where the document is published 	<p>SF name] produced this SF document as required by EC Implementing Regulation 2017/2177. [SF name] is a (choose one or more categories from a) to i) from Directive 2012/34 Annex II) [SF name] is a company dedicated to ... (give a brief presentation of the SF)</p> <p>This SF document is published at www.xxxxxx.xx</p>
1.2	Service Facility operator	<ul style="list-style-type: none"> Name, address and contact details for all SF operators (b) If the SF is operated by more than one operator or where rail-related services are provided by more than one operator, an indication shall be given as to whether separate requests for access to the facilities and for those services need to be submitted (g)* 	
1.3	Validity period and updating process	<ul style="list-style-type: none"> State the dates of the period of validity of the SF document Describe how the SF document is updated 	<p><i>Examples:</i></p> <ul style="list-style-type: none"> <i>This document is updated yearly at the time of the Network Statement publication, unless changes in its content require extraordinary updates</i> <i>This document is updated yearly at XX of XXXXX, unless changes in its content require additional updates</i> <i>This document is updated when necessary.</i>
2	Services		
2.X	Name of service	<ul style="list-style-type: none"> Description of all rail-related services, which are supplied in the SF, and their type (basic, additional or ancillary) (d). See also Annex II of Directive 2012/34/EU Alternatively, publish a link to a website which provides all relevant information X refers to the number of provided services 	
3	Service Facility description		
3.1	List of all installations	<ul style="list-style-type: none"> Where relevant, the list of all installations in which rail-related services are supplied (a) <p>[Note: If it is possible to integrate all information of the 3.X subchapters into a single table inside 3.1 (each line corresponding to an installation and the different columns referring to 'Location', 'Opening hours', 'Technical characteristics' and 'Planned changes in technical characteristics'), then the inclusion of subchapters 3.X shall not be necessary]</p>	<p>In the case of a SF with just one installation:</p> <ul style="list-style-type: none"> This SF consists of only one installation. <p>In the case of highly complex SFs that have already published information for their SFs meeting the requirements of IR 2017/2177:</p> <ul style="list-style-type: none"> The list of installations is published at www.xxxxxxxxxxxx <p>The description of these installations is published at www.xxxxxxxxxx [in this case chapters 3.2 to 3.X may be omitted]</p>

Chapter number	Heading	Implementation guide	Suggested text
3.X	Name of installation X	<ul style="list-style-type: none"> • X is a placeholder, so the chapters per installation can be numbered in a consistent way. • If the SF has only one installation, the chapter numbering will end with 3.2.4. If the SF has two installations, the chapter numbering will end with 3.3.4. 	
3.X.1	Location	<ul style="list-style-type: none"> • Installation location 	<p>Examples:</p> <ul style="list-style-type: none"> • GPS coordinates of the installation • How to find the installation • Road access • Location of the connection to the main railway infrastructure, including where relevant the name of the connecting railway station
3.X.2	Opening hours	<ul style="list-style-type: none"> • Installation opening hours 	<p>Examples:</p> <ul style="list-style-type: none"> • Opening hours <ul style="list-style-type: none"> ○ Monday – Friday ○ Saturday – Sunday ○ Holiday opening hours ○ Festive period, bank holidays • Operating times of particular services (a) <ul style="list-style-type: none"> ○ Opening hours ○ Monday – Friday ○ Saturday – Sunday ○ Holiday opening hours ○ Festive period, bank holidays
3.X.3	Technical characteristics	<ul style="list-style-type: none"> • Where relevant, a description of the technical characteristics of the installation 	<p>Examples:</p> <ul style="list-style-type: none"> • Technical Parameters • Private branch line: Number and length of tracks (TEN-T parameters) • Sidings: Number and length of tracks (TEN-T parameters) • Shunting and marshalling tracks: Number and length of tracks (TEN-T parameters) • Technical equipment for loading and unloading: Equipment (cranes, ramps, stackers) • Technical equipment for washing • Technical equipment for maintenance • Storage area (m2)
3.X.4	Planned changes in technical characteristics	<ul style="list-style-type: none"> • Information on changes in technical characteristics and temporary capacity restrictions of the service facility, which could have a major impact on the service facility's operation, including planned works (I)* 	<p>Examples:</p> <ul style="list-style-type: none"> • Details of indicative investments <ul style="list-style-type: none"> ○ List of projects ○ Location ○ Nature of project ○ Start/End date of the works
4	Charges		
4.1	Information on charges	<ul style="list-style-type: none"> • Information on charges for getting access to SFs and charges for the use of each rail-related service supplied therein (m) 	

Chapter number	Heading	Implementation guide	Suggested text
4.2	Information on discounts	<ul style="list-style-type: none"> Information on principles of discount schemes offered to applicants, while respecting commercial confidentiality requirements (n)* 	
5	Access conditions		
5.1	<i>Legal requirements</i>	<ul style="list-style-type: none"> <i>Information stating whether a contract, certificates or insurance are necessary</i> Model access contracts and general terms and conditions (at least in the case of SFs operated and rail-related services provided by operators under the direct or indirect control of a controlling entity) (i)* 	
5.2	<i>Technical conditions</i>	<ul style="list-style-type: none"> <i>Where relevant, description of technical conditions to be satisfied by the rolling stock entering the SF</i> 	<p><i>Examples:</i></p> <ul style="list-style-type: none"> <i>Rolling stock type</i> <i>Maximum train length, gauge, weight</i>
5.3	Self-supply of rail-related services	<ul style="list-style-type: none"> Information on the possibility for self-supply of rail-related services and conditions applying thereto (e)* 	
5.4	IT systems	<ul style="list-style-type: none"> Where relevant, information on the terms of use of the operator's IT systems, if applicants are required to use such systems, and the rules concerning the protection of sensitive and commercial data (j)* 	
6	Capacity allocation		
6.1	Requests for access or services	<ul style="list-style-type: none"> Information on procedures for requesting access to the SF or services supplied in the SF, or both, including deadlines for submitting requests, and time limits for handling those requests (f)* and (Article 8)* In SFs operated by more than one operator or where rail-related services are provided by more than one operator, an indication shall be given as to whether separate requests for access to the facilities and for those services need to be submitted (g)* Information on the minimum content and format of a request for access to the SF and rail-related services, or a template for such a request (h)* 	
6.2	Response to requests	<ul style="list-style-type: none"> Description of the response to requests (Article 9)* A description of the coordination procedure and regulatory measures referred to in Article 10 and priority criteria referred to in Article 11 (k)* 	
6.3	Information on available capacity and temporary capacity restrictions	<ul style="list-style-type: none"> Information on temporary capacity restrictions of the SF, which could have a major impact on the SF's operation, including planned works (l)* 	

Annex "M"

Use of codes in justifying train delays on railways operated by Správa železnic and dispute resolution procedures

Use of codes in justifying train delays on railways operated by Správa železnic

This appendix explains how to use timetable violation codes when justifying train delays.

The timetable violation code is assigned to three basic groups based on the responsibility for its origin:

- a. railway operator (SŽ) = codes D, S, Z;
- b. carrier = codes V, K;
- c. other and secondary reasons (third party influence, force majeure, transfer delay) = codes O, X;

All timetable violation codes apply to all train types. The meaning of individual timetable violation codes is based on the name itself, however, some timetable violation codes have multiple meanings. The detailed meaning of individual timetable violation codes is described in the table below. If there is a case where it is not possible to select the appropriate type of disruption to the timetable, the assigning employee of the railway operator proceeds by assigning the type of disruption corresponding to the basic division group (railway operator, carrier, external reasons) and consults the case with the relevant workplace of the operational dispatcher, or analyzes of the CDP timetable, in whose area of competence the employee falls according to the Implementing Regulations to the Regulation for the operative management of the operation of part A. An increase in train delay of 1 minute (or less) is always justified when the reason for the increased train delay is known or obvious. If the cause of the increase in such delay is not known or obvious, entering a train disturbance is not mandatory.

Description of the railway operator's timetable violation codes

Violation code	UIC code	Legislation code ¹⁴	Description of the cause of the violation
Timetabling and operational reasons			
D0	10	1 a) 1	Sestava jízdního řádu
D1	11	1 a) 5	Sestava vlaku provozovatelem dráhy
D2	12	1 a) 2	Závady v provozních procesech
D3	13	1 a) 4	Pořadí vlaků z důvodu chybného řízení provozu
D4	18	1 a) 3	Zpoždění zaviněné zaměstnanci provozu
D9	19	1 a) 5	Dispozice provozovatele dráhy, dispečera řízení provozu
Infrastructural reasons			
Z0		1 b) 1	Vliv zabezpečovacích zařízení (pro příjem od dopravců)
Z1	20	1 b) 1	Vliv staničních zabezpečovacích zařízení
Z2	20	1 b) 1	Vliv traťových zabezpečovacích zařízení
Z3	21	1 b) 2	Vliv přejezdových zabezpečovacích zařízení
Z4	22	1 b) 3	Vliv sdělovacích zařízení

¹⁴ Vyhláška 76/2017 Sb., o obsahu a rozsahu služeb poskytovaných dopravci provozovatelem dráhy a provozovatelem zařízení služeb, § 4

Violation code	UIC code	Legislation code ¹⁴	Description of the cause of the violation
Z5	23	1 b) 4	Vliv trakčního vedení a zásobování elektrickou energií
Z6	24	1 b) 5	Závady na železničním svršku
Z7	25	1 b) 6	Závady staveb železničního spodku
Z8	28	1 b) 7	Zpoždění zaviněné zaměstnanci infrastruktury
Z9	29	1 b) 9	Ostatní závady infrastruktury
Maintenance and construction			
S1	30	1 c) 1	Vliv plánovaných výluk
S2	31	1 c) 2	Vliv nepředpokládaných výluk, pozdě zahájených a ukončených výluk
S3	32	1 c) 3	Omezení rychlosti z důvodu stavu koleje
S8	38	1 c) 4	Zpoždění způsobené zaměstnanci infrastruktury SŽ a zhotovitele stavebních prací
S9	39	1 c) 4	Ostatní závady ve výlukové činnosti

Description of the RU's timetable violation codes

Violation code	UIC code	Legislation code ¹⁴	Description of the cause of the violation
Transport and commercial reasons			
K1	54	2 a) 5	Pozdní doručení přepravních dokladů
K2	52	2 a) 3	Nakládka, vykládka
K3	50	2 a) 1	Prodloužení plánovaného pobytu, zvýšená frekvence cestujících
K4	53	2 a) 2 2 a) 4	Úprava nákladu, zpoždění způsobené přepravovanou zásilkou
K5	51	2 a) 2 2 a) 5	Dispozice dopravce
K6	58	2 a) 6	Zpoždění zaviněné obsluhou vlaku a komerčními zaměstnanci dopravce
K9	59	2 a) 7	Ostatní přepravní závady
Vehicles and train composition			
V0	60	2 b) 1	Použití jiné řady železničního vozidla, nedodržení řazení podle jízdního řádu
V1	61	2 b) 2	Sestava vlaku dopravcem
V2	62	2 b) 3	Technické závady osobních vozů
V3	63	2 b) 4	Technické závady nákladních vozů
V4	64	2 b) 5	Technické závady hnacích vozidel
V5	68	2 b) 6	Zpoždění zaviněné lokomotivní četou
V9	69	2 b) 7	Ostatní závady vozidel

Description of other and secondary reason violation codes

Violation code	UIC code	Legislation code ¹⁴	Description of the cause of the violation
other and secondary reasons			
O0	95	3 n)	Ihned nerozlišitelné důvody narušení (ostatní blíže nespecifikované události)
O1	90	3 e)	Vliv mimořádných událostí
O2	83	3 c)	Povětrnostní vlivy
O3	94	3 i)	Čekání na přípoj v rámci čekacích dob
O4	81	3 b)	Opatření státních orgánů
O5	84	3 d)	Zpoždění z jiných příčin na síti sousedního provozovatele
O6	82	3 j) 3 k) 3 l) 3 m)	Zásah policie, IZS
O7	80	3 a)	Stávka
O8	92	3 f) 3 g)	Pořadí vlaků (křižování, sled, předjíždění, provozní intervaly, následná mezidobí)
O9	93	3 h)	Zpožděný obrat v konečné stanici
X1	40	1 d) 1	Zpoždění následujícím provozovatelem dráhy
X2	41	1 d) 2	Zpoždění předchozím provozovatelem dráhy
X3	70	2 c) 1	Zpoždění způsobené přebírajícím dopravcem
X4	71	2 c) 2	Zpoždění způsobené předchozím dopravcem

Rules for working with the Train ready message

In accordance with the internal regulations of the railway operator Správa železnic and the provisions of TSI TAF and TSI TAP, the carrier is obliged to provide the railway operator with information about the composition of the train and the time when it is ready to depart before the departure of each train. Information about the time when its train is ready to depart is transmitted by the carrier with the message Train ready. With the Train ready message, the carrier announces that it has met all the necessary conditions for the departure of the train from the specified transport point at the time specified in this message and that it is ready to depart immediately after the train path has been constructed. This information is the basis for assigning the responsibility of the carrier and the railway operator for the delay at the initial transport point before the departure of the train or at the transport point where the carrier is obliged to obtain the Train ready report.

If the train is not ready at the time specified in the Train ready message, the carrier **must**:

- **cancel the previously sent information** by sending a new message Train ready with status 3 - cancellation, if all the necessary conditions for the departure of the train from the specified transport point are not met.
- **modify previously sent information** by sending a new message Train ready with status 2 - correction if the train will be ready for departure later than the carrier stated in the previously sent message

The Správa železnic will, if the immediate operating conditions permit, allow the train to depart at the time indicated in the Train Ready message if it receives this message at least 10 minutes before the time indicated in the Train Ready message. Otherwise, within 10 minutes of receiving the message.

Waiting for a connection within the waiting times

The use of the O3 code " Čekání na přípoj v rámci čekacích dob " is tied to the processed technology at the given transport point. In this case, the RU is obliged to state its requirements for connections between trains as part of the timetable (see chapter 4.2.2 of this Network Statement). The use of the O3 code is not possible for ad hoc connections between trains that are not processed in the timetable. In this case, the code K5 " Dispozice dopravce " is used.

Delayed turnaround at the final station

The use of the code O9 " Zpožděný obrat v konečné stanici " is tied to the processed technology at the destination transport point of the train. In this case, the RU is obliged to indicate its requirements for turns at the final station as part of the timetable (see chapter 4.2.2 of this Network Statement). The use of the O9 code is not possible for ad hoc turns that are not processed in the timetable, or for turns that take place outside the track operated by the Správou železnic. In these cases, the code K5 " Dispozice dopravce " is used.

Defect indication on the RU's train by diagnostic equipment

Codes V2, V3, V4 or V9 is used in this case. Code Z9 is used in the case of proven malfunction of the diagnostic equipment.

Change of place of execution of a change of driving vehicle or replacement of a locomotive crew within a node

In the event that, following the agreement of the RU with the railway operator, the operation "Přepřah HVI" or " Výměna lokomotivní čety – osa" is performed at a different point within the node than is planned in the timetable, but there is no increase in the stay within the node (there will be no occurrence of a delay within the node) is used to justify the disturbance at the point where the action actually took place, code O0. The individual nodes for the application of this rule are defined as follows:

Nod Beroun:

- 730747 Beroun os.n.
- 780007 Beroun seř.n.

Nod Bohumín:

- 341248 Bohumín os.n.
- 380006 Bohumín přednádraží

Nod Břeclav:

- 334250 Břeclav os.n.
- 380014 Břeclav přednádraží

Nod Česká Třebová

- 539130 Česká Třebová
- 580019 Č.Třebová odj.sk.
- 580027 Č.Třebová vjezd.sk.

Nod Český Těšín:

- 332346 Český Těšín
- 380030 Český Těšín nákl. n.

Nod Děčín:

- 556597 Děčín hl.n.
- 580035 Děčín hl.n.nákl.n.
- 556092 Děčín-Prostřed. Žleb

Nod Nymburk:

- 532143 Nymburk hl.n.
- 580837 Nymburk předjízd.n.

Nod Olomouc:

- 343624 Olomouc hl. n.
- 380048 Olomouc přednádraží

Nod Ostrava:

- 343640 Ostrava hl.n.
- 380246 Ostrava pravé n.
- 380147 Ostrava levé n.
- 380055 Ostrava hl.n. OMH
- 380709 Ostrava hl.n. ONV

Nod Plzeň

- 732750 Plzeň hl.n.os.n.
- 780031 Plzeň hl.n.lobez.k.

Nod Přeřov:

- 346627 Přeřov os. n.
- 380220 Přeřov přednádraží

Examples of model situations

Timetable violation codes filled in automatically:

- a) D2 – after 24 hours from the end of the train unless the delay is justified,
- b) O5 – immediately at the entry point of the "state border" or "infrastructure border".

Defect of driving vehicle or wagon → following train:

- a) of the same RU = O8,
- b) other RU = O8.

Recorded replacement transport, driving on a diversion / detour route, prohibition disposition:

- a) due to infrastructure = Z1 - Z9,
- b) for lockout and construction reasons = S1 - S9,
- c) due to an accident = O1,
- d) due to weather conditions = O2,
- e) due to the intervention of the police, the integrated rescue system (hereinafter referred to as "IZS") and theft or intentional damage to equipment = O6,
- f) for a reason contained in the "V" series of codes= V1 - V9 (if they are the same RU),
- g) for transport and commercial reasons = K1 - K9 (if they are the same RU),
- h) due to the fault of another RU = O0,
- i) if the reason for granting the prohibition order is not known = D9.

Exceeding the agreed time of shunting including PMD disrupted by trains:

- a) due to the fault of the RU = O8,
- b) due to the fault of the employees of the Správa železnic = D4,
- c) due to infrastructure device fault= Z1 – Z9,
- d) due to the fault of IM employees = Z8,
- e) due to an accident = O1,
- f) due to weather conditions = O2,
- g) due to the intervention of the police, the IZS and theft or intentional damage to equipment = O6.

Infrastructure equipment failures:

- a) due to theft or intentional damage, etc. = O6,
- b) unintentional damage (e.g. cable kicked over during construction work) = Z1 – Z9, S1 – S9,
- c) due to failure = Z1 – Z9, S1 – S9.

ETCS faults:

- a) the dispatcher has an indication of failure of the ETCS track section – Z2,
- b) the train driver reports a failure of the vehicle part – V4,
- c) the dispatcher has an indication of a failure of the ETCS track part and at the same time the train driver reports a failure of the vehicle part - Z2,
- d) no known cause – O0.

track blocking:

- a) due to the fault of the locomotive crew = V5 (for the own train), O8 (for the affected train),

- b) due to the fault of employees of the Správa železnic = D4,
- c) due to the RU's incorrectly stated train composition = K9.

Using the emergency brake:

- a) due to unknown causes = K9,
- b) misuse of emergency brake = K9,
- c) when the cause of use is found = code according to the cause.

Transportation of employees of the Správa železnic:

- a) to/from the shift = D9,
- b) to remove a defect in infrastructure equipment, obstacles, etc. = Z9, S9.

Late termination of track closure:

- a) for construction-technological and transport reasons = S2,
- b) due to the fault of the infrastructure employees of the Správa železnic = S2 (S8),
- c) due to the fault of the contractor = S2,
- d) due to the fault of employees of the operation management of the Správa železnic = D4,
- e) due to an accident = O1,
- f) due to weather conditions = O2,
- g) due to the intervention of the police, the IZS and theft or intentional damage to equipment = O6.

Waiting for a connection within the waiting times:

- a) according to the document „Přípoje mezi vlaky“ = O3,
- b) modified by Výlukový rozkaz = O3,
- c) according to the RU's disposition = K5.

Procedure for impartial dispute resolution system

As part of the impartial dispute resolution system, the person who ensures this activity for the Správa železnic is provided with all the information that is provided both by the Správa železnic and by the RU as part of the dispute in IS ISOŘ. In the event that it is necessary to provide additional documents for a decision within the framework of impartial dispute resolution system, these will be provided through the Správa železnic. The Správa železnic shall ensure that both parties to the dispute (both the Správa železnic and the RU) are made available to all additional documents provided to the arbitrator for the decision of the dispute, with the exception of information involving trade secrets of third parties. The RU can report to the Správa železnic at the contact e-mail for the sanctioning system (see chapter 1.6 of this Network Statement) the contact of the person who will act on behalf of the RU in this regard.

Annex "N"

Conditions for granting permission to occupy tracks

A. Short-term technological parking of railway vehicles on the tracks with a special regime

Common condition

The special conditions specified in this appendix apply to the granting of approval for the occupation of tracks with a special regime for short-term technological parking of railway vehicles. The list of tracks with a special regime is published on the Railway Operation Portal.

The Správa železnic operates the KAZAS web application for submitting requests for approval to occupy tracks with a special regime. This application is available at <https://kazas.spravazeleznic.cz>.

The RU shall submit in electronic form to the Správa železnic a list of the names of its employees who are authorized to submit requests for granting approval for the occupation of tracks with a special regime via the KAZAS web form, and is obliged to update this list in time to the Správa železnic in the event of any change. To submit the name list, the RU will use the form " Žádost o vytvoření nových přístupů na Portál PD a IS pro uživatele " published on the Railway Operation Portal (<http://provoz.spravazeleznic.cz>) in the Portal section. The completed form will be sent by the RU to the e-mail address

In the event that the KAZAS web form is unavailable, the RU submits requests for approval to occupy tracks with a special regime via the e-mail listed in the list of tracks with a special regime published on the Railway Operation Portal.

Submitting a request for approval to occupy a track with a special regime

Requests for granting consent to occupy a track with a special regime are submitted electronically by the RU via the KAZAS web application (<https://kazas.spravazeleznic.cz>). The request must be submitted in the Czech language.

Requests for approval to occupy a track with a special regime must be submitted no later than three working days before the start date of occupation. The Správa železnic will accept the request even in a shorter period, but does not guarantee its timely processing. The time of submission of the request means the time of receipt of the request via the web application. The Správa železnic will handle the request no later than two working days after its submission.

Granting consent to occupy a track with a special regime

The Správa železnic will grant approval for the occupation of a track with a special regime on the condition that:

- the requested track is operational;
- there is no planned restriction of track operation on the requested track for the entire requested period;
- consent has not already been granted to another RU for the entire required period.

In the event that the above conditions are met only for part of the required time, it is possible to grant consent only for the period during which the above conditions are met, in agreement with the RU.

When granting approval for the occupation of tracks with a special regime, the Správa železnic proceeds in a non-discriminatory manner towards all RU. In case of conflicts between two or more requirements, the Správa železnic will first try to reach an agreement with the RUs. In the event that an agreement is not reached, the Správa železnic will preferentially grant consent to the RU that submitted the request earlier.

When coordinating the requirements according to the previous paragraph, the Správa železnic may, to the extent necessary, deviate from the required scope of the granting of consent, if it is suitable for more efficient use of the track, while making sure that the purpose for which the consent to occupy the track with a special regime by the RU is preserved required. If it is expedient and technically possible, the Správa železnic can grant permission to occupy these tracks simultaneously to several RUs. In such a case, the Správa železnic has the right to determine the technology of cooperation between RUs and to demand the technical provision of this cooperation (e.g. the presence of a driving vehicle for movement of railway vehicles).

The right to occupy a track with a special regime arises for the RU only after the approval of the Správa železnic. If the RU does not intend to occupy a track with a special regime to the full extent of the consent granted, it is obliged to cancel its request via the KAZAS web form at least 24 hours in advance. If he does not do so, he is responsible for all damage that both the Správa železnic and third parties incur due to the failure to grant consent to another applicant.

Revocation of consent

The Správa železnic is entitled to cancel the consent granted for the occupation of tracks with a special regime in cases where it is necessary to carry out activities ensuring the operability of the railway, especially due to unplanned restrictions on the operation of the railway and periodic inspections, or in cases where it is necessary for the fulfillment of the obligations of the Správa železnic arising from the applicable legislation (e.g. Act No. 222/1999 Sb., o zajišťování obrany České republiky).

In cases where the RU has repeatedly grossly violated the conditions for occupying tracks with a special regime or has repeatedly failed to release these tracks in accordance with the consent granted, it will call the RU to rectify the situation. If the RU continues to grossly violate the conditions or repeatedly does not clear the tracks in accordance with the consent granted, the Správa železnic reserves the right to cancel the consent granted to the RU and not to grant any further consent in the following 30 days from the date of cancellation of the consent.

In the case of cancellation of approval for the occupation of special-purpose tracks, the Správa železnic is always obliged to immediately inform the RU of this fact and of the reasons that led to the cancellation of approval. The Správa železnic will notify the cancellation of consent, unless serious circumstances prevent it (e.g. extraordinary event, state administration decision, technical condition of the railway, etc.), no later than 72 hours in advance. In this case, the RU is obliged to release the relevant track within the specified period.

Vacating the track with a special régime

The RU is obliged to vacate the track and enter the date and time of the vacating of the track in the KAZAS web application after the expiry of the period of consent to occupy the track, within 96 hours of the release at the latest. If he does not do so, the track will not be vacated and the RU is responsible for all damage caused to both the Správa železnic and third parties as a result of the failure to vacate the track, and is obliged to pay a sanction to the Správa železnic. A track with a special regime is considered to be freed at the moment when all railway vehicles are removed by the RU, any material is cleared, the track is freed of all dirt and the release of the track is entered in the KAZAS web application.

Sanctions for not releasing a track with a special regime

If the RU does not vacate the track after the expiry of the consent to occupy the track with the special regime, it is responsible for all damage that both the Správa železnic and third parties incur due to the non-vacation of the track, and is obliged to pay the Správa železnic a contractual penalty in the amount according to the following paragraph for each such track until the track is released. The Správa železnic is not entitled to demand payment of the penalty if the RU could not vacate the track due to reasons on the part of the Správa železnic that the RU could not foresee.

The penalty for not vacating a track with a special regime is calculated for each started hour of exceeding the granted approval. The amount of the hourly penalty rate increases with the length of time of exceeding the granted consent. The rates for individual started hours of exceeding the granted consent are listed in the following table:

	Amount the sanction [CZK/started hour]
The amount of the penalty for each started hour in the period from the 1 st to the 24 th hour	50,-
The amount of the penalty for each started hour in the period from the 25 th to the 48 th hour	100,-
The amount of the penalty for each started hour in the period from the 49 th to the 72 th hour	150,-
The amount of the penalty for each started hour in the period from the 73 th to the 96 th hour	200,-
The amount of the penalty for each started hour in the period from the 97 th hour	250,-

The RU is obliged to pay the sanction according to the previous paragraph even in the case of failure to enter data on track clearance or incorrect or false data on track clearance in the KAZAS web form (e.g. the site is not cleared of all dirt), until the correct data on track clearance is entered or until it is actually released in accordance with the rules set out in this Annex.

B. Short-term technological parking of railway vehicles on other tracks

Submitting a request for approval to occupy a track

For the short-term technological parking of railway vehicles, the RU applies to the Správa železnic through a request submitted electronically by e-mail to the address of the technology department of the relevant operating district of the Railway Správa železnic. A map of the operational district and a list of e-mail addresses of the technology department are available on the Railway Operation Portal (<https://provoz.spravazeleznic.cz>). The request must be submitted in the Czech language.

The request for short-term technological parking of railway vehicles outside the service facilities Parking Sidings must contain at least:

- a) Identification of the RU;
- b) Designation of the track (transportation point, track) where the RU wants to perform a short-term technological parking of railway vehicles;
- c) Determination of the period from when (date and time) until (date and time) the RU wants to parking the railway vehicles;
- d) Information on whether it is a one-time or repeated short-term technological parking of railway vehicles (in the case of repeated use, specify its frequency);
- e) Total length of parked railway vehicles;

- f) Contact details of the employee of RU authorized to submit a request for the short-term technological parking of railway vehicles outside the service facilities Parking Sidings. The person authorized to submit the request is the person listed in the commercial register or the person designated by the RU in accordance with the contract between the RU and the Správa železnic.

Requests for the short-term technological parking of railway vehicles outside the service facilities Parking Sidings submitted in connection with the request for the capacity to the annual timetable and its regular changes (regular request to the timetable, late request to the timetable, request to change the timetable) must be submitted no later than 60 calendar days before the deadline for the allocation of capacity to the annual timetable or its regular changes specified in this Network statement. Requests for ad hoc short-term technological parking of railway vehicles outside the service facilities Parking Sidings in connection with long-term ad hoc requests for track capacity must be submitted no later than 20 working days before the date of the first requested short-term technological parking of railway vehicles outside the service facilities Parking Sidings. Requests for ad hoc short-term technological parking of railway vehicles outside the service facilities Parking Sidings submitted in connection with other ad hoc requests for track capacity or unrelated to the request for capacity must be submitted no later than 3 working days before the date of the first requested short-term technological parking of railway vehicles outside the service facilities Parking Sidings. The Správa železnic will accept the request even in a shorter period, but does not guarantee its timely processing. The time of submission of the request is understood as the time of delivery of the e-mail with the request to the relevant e-mail box. If an e-mail request is sent with incomplete data, the request will be returned to the RU for completion. The time of submission of the request is then understood as the time of delivery of the request with complete data.

In the case of long-term requests for the short-term technological parking of railway vehicles outside the service facilities Parking Sidings submitted in connection with the request for capacity in the annual timetable and its regular changes (regular request for the timetable, late request for the timetable, request for a change in the timetable) Správa železnic handle the request no later than the deadline for the allocation of capacity to the timetable and its regular changes specified in this Network Statement. In the event of a request for short-term technological parking of railway vehicles outside the service facilities Parking Sidings submitted in connection with a long-term ad hoc request for track capacity, the Správa železnic will handle the request within 15 working days. In other cases, Správa železnic will handle the request no later than three working days after the request is submitted.

Granting consent to occupy a track

In the event of a request for a short-term technological parking of railway vehicles outside the service facilities Parking Sidings, consent will be granted on the condition that:

- the required track is intended for short-term technological parking of railway vehicles;
- the requested track is operational;
- there is no planned restriction of track operation on the requested track for the entire requested period;
- for the entire required period, another RU has not already been granted permission to park railway vehicles on this track;
- occupation of the track by short-term technological parking of railway vehicles will not have a negative effect on the required capacity of the respective track.

In the event that the above conditions are met only for part of the required time, it is possible to grant consent only for the period during which the above conditions are met, after agreement with the RU.

If there is a conflict between two or more requests, approval will be given preferentially to the request that is linked to the route that has been allocated track capacity for a higher frequency of trips. In the event of a match in the frequency of rides, approval will be given in priority to the request that was submitted earlier.

Cancellation of consent to occupy a track

The Správa železnic is entitled to cancel the already granted consent to occupy the track in cases where it is necessary to carry out activities ensuring the operability of the track, especially for reasons of limiting the track's operation and periodic inspections.

In the event of the cancellation of an already granted approval to occupy a track, the Správa železnic is always obliged to immediately inform the RU of this fact and of the reasons that led to the cancellation of the approval. The Správa železnic will announce the withdrawal of capacity, unless serious circumstances prevent it (e.g. an extraordinary event, state administration decision, technical condition of service equipment, etc.), no later than 72 hours in advance. In this case, the RU is obliged to release the track in accordance with the remaining period of approval.

Sanctions for not releasing the track

The RU is authorized to park railway vehicles on the track only with the prior consent of the Správa železnic and only for the period of validity of the given consent. The RU is obliged to vacate the track and remove all parked railway vehicles after the expiry of the period of consent to the parking of railway vehicles.

If the RU does not clear the track after the expiry of the period of consent to the technological parking of railway vehicles outside the service facilities Parking Sidings and does not remove all parked railway vehicles, it is responsible for all damage caused to both the Správa železnic and third parties due to the non-clearance of the track and is obliged to pay the Správa železnic a contractual sanction for every track and for every 24 hours that have started, exceeding the consent period until the time when the track is released and all railway vehicles are removed. The Správa železnic is not entitled to demand payment of the sanction if the RU could not clear the track for reasons on the part of the Správa železnic. The RU is obliged to pay the same sanction to the Správa železnic in the event that it carries out a short-term technological parking of railway vehicles outside the service facilities Parking Sidings without the consent of the Správa železnic.

The amount of the sanction for not vacating a track intended for short-term technological parking of railway vehicles outside the service facilities Parking Sidings is shown in the following table:

Sanctions for not releasing the track	Amount of sanction [CZK/started 24 hour]
Sanction for every started 24 hours	50,-

C. Operational short-term parking of railway vehicles

Submitting a request for approval to occupy a track

For the operational short-term parking of railway vehicles, the RU requests the relevant chief dispatcher of the Správa železnic by telephone and then also by means of a request submitted electronically by e-mail. A map of the scope of individual chief dispatchers and a list of their contacts (phone numbers and e-mail addresses) are available on the Railway Operation Portal (<https://provoz.spravazeleznic.cz>). The request must be submitted in the Czech language.

The request for short-term operational shutdown of railway vehicles outside the service facilities Parking Sidings must contain at least:

- a. Identification of the RU;

- b. Designation of the track (transportation point, track) where the RU wants to perform a operational short-term parking of railway vehicles;
- c. Determination of the period from when (date and time) until (date and time) the RU wants to park the railway vehicles;
- d. Total length of parked railway vehicles;
- e. e. Contact details of the employee of RU authorized to submit a request for the operational short-term parking of railway vehicles outside the service facilities Parking Sidings. The person authorized to submit the request is the person listed in the commercial register or the person designated by the RU in accordance with the contract between the RU and the Správa železnic.

Granting consent to occupy a track

In the event of a request for a operational short-term parking of railway vehicles outside the service facilities Parking Sidings, consent will be granted on the condition that:

- the required track is listed in the Prováděcím nařízením k předpisu pro operativní řízení provozu Správy železnic D7, part A, as a track intended for operational short-term parking of railway vehicles,
- the requested track is operational,
- there is no planned restriction of track operation on the required track for the entire required time,
- for the entire required period, another RU has not already been granted permission to park railway vehicles on this track,
- occupation of the track by operational short-term parking of railway vehicles will not have a negative effect on the required capacity of the respective track,
- occupation of the track by railway vehicles will not have a limiting effect on the station's work technology (running of trains, moving parts and possible manipulations) for the entire required time.

In the event that the above conditions are met only for part of the required time, it is possible to grant consent only for the period during which the above conditions are met, after agreement with the RU. If the track requested by the RU does not allow operational short-term parking of rail vehicles for the entire required time, the operational dispatcher can offer the RU another suitable track for operational short-term parking of rail vehicles, even in another station.

If there is a conflict between two or more requests, consent will be given in preference to the request that was submitted earlier.

Cancellation of consent to occupy a track

The Správa železnic is entitled to cancel the already granted consent to occupy the track in cases where it is necessary to carry out activities ensuring the operability of the track, especially for reasons of limiting the track's operation and periodic inspections.

In the event of the cancellation of an already granted approval to occupy a track, the Správa železnic is always obliged to immediately inform the RU of this fact and of the reasons that led to the cancellation of the approval. The Správa železnic will announce the withdrawal of capacity, unless serious circumstances prevent it (e.g. an extraordinary event, state administration decision, technical condition of service equipment, etc.), no later than 72 hours in advance. In this case, the RU is obliged to release the track in accordance with the remaining period of approval.

Sanctions for not releasing the dormitory

The RU is authorized to park railway vehicles on the track only with the prior consent of the Správa železnic and only for the period of validity of the given consent. The RU is obliged to vacate the track and remove all parked railway vehicles after the expiry of the period of consent to the parking of railway vehicles.

If the RU does not clear the track after the expiry of the period of consent to the operational parking of railway vehicles outside the service facilities Parking Sidings and does not remove

all parked railway vehicles, it is responsible for all damage caused to both the Správa železnic and third parties as a result of the failure to clear the track and is obliged to pay the Správa železnic a contractual sanction for every track and for every 24 hours that have started, exceeding the consent period until the time when the track is released and all railway vehicles are removed. The Správa železnic is not entitled to demand payment of the sanction if the RU could not clear the track for reasons on the part of the Správa železnic. The RU is obliged to pay the same sanction to the Správa železnic in the event that it carries out a operational short-term parking of railway vehicles outside the service facilities Parking Sidings without the consent of the operational dispatcher.

The amount of the sanction for not vacating a track intended for operational short-term parking of railway vehicles outside the service facilities Parking Sidings is shown in the following table:

Sanctions for not releasing the track	Amount of sanction [CZK/started 24 hour]
Sanction for every started 24 hours	50,-

Annex "O"

Internal regulations of the railway operator Správa železnic binding for RU and non-RU applicants

Internal regulations of the railway operator Správa železnic binding for non-RU applicants

List of internal regulations of the railway operator Správa železnic binding for non-RU applicants

Marking	Name	Link	Comment
SŽ D1 ČÁST PRVNÍ	Dopravní a návěstní předpis pro tratě nevybavené evropským vlakovým zabezpečovačem	Portál provozování dráhy	Rozsah znalostí: Kapitola I Díl 1 a Díl 2, Kapitola VIII., Kapitola IX, Kapitola XX
SŽ D7/2	Organizování výlukových činností	Portál provozování dráhy	Rozsah znalostí jako Zaměstnanci dopravce zpracovávající dílčí opatření do VR, zaměstnanci podílející se na koordinaci opatření při výlukách na základě smluvního vztahu se Správou železnic
SŽDC D31	Mimořádné zásilky	Portál provozování dráhy	Rozsah znalostí jako osoby dopravce odpovědné za projednávání přepravy MZ
SŽDC (ČD) D40	Předpis pro organizování drážní dopravy na tratích Liberec - Tanvald - Železný Brod; Tanvald - Harrachov; Smržovka - Josefův Důl	Portál provozování dráhy	Rozsah znalostí jako ostatní zaměstnanci, kteří vykonávají dopravní službu na tratích dle předpisu ČD D40
SŽ Is10	Předpis pro užívání souboru provozních informačních systémů provozovatele dráhy (SPIS)	Portál provozování dráhy	Rozsah znalostí jako dopravce
Směrnice SŽ SM069	Směrnice pro tvorbu jízdního řádu a přidělování a využívání kapacity dráhy	Portál provozování dráhy	Rozsah znalostí jako zaměstnanci dopravců a žadatelů podílející se na přípravě JŘ, podávající žádosti o kapacitu dráhy a mající znalost této Směrnice na základě smluvního vztahu se SŽ
Směrnice SŽ SM071	Protipožární opatření při provozování parních lokomotiv na železniční dopravní cestě, kterou provozuje státní organizace Správa železnic	Portál provozování dráhy	Rozsah znalostí viz vnitřní předpis
Směrnice SŽ SM100	Směrnice pro poskytování informací cestujícím ve stanicích a na zastávkách prostřednictvím provozovatele dráhy	Portál provozování dráhy	Rozsah znalostí jako dopravci osobní dopravy – zaměstnanci pověřeni poskytováním podkladů ve věci objednávání služby informování cestujících

Internal regulations of the railway operator Správa železnic binding for RU

List of internal regulations of the railway operator Správa železnic binding for RU

Marking	Name	Link	Comment
SŽ Bp1	Pokyny provozovatele dráhy k zajištění bezpečnosti a k ochraně zdraví osob při činnostech a pohybu v jeho prostorách a v prostorách železniční dráhy provozované státní organizací Správa železnic	Portál provozování dráhy	Rozsah znalosti viz vnitřní předpis
SŽ D1 ČÁST PRVNÍ	Dopravní a návěštní předpis pro tratě nevybavené evropským vlakovým zabezpečovačem	Portál provozování dráhy	Rozsah znalosti viz vnitřní předpis
SŽDC (ČD) D2/1	Doplněk s technickými údaji k Dopravním předpisům	Portál provozování dráhy	Rozsah znalosti viz vnitřní předpis
SŽ D3	Předpis pro zjednodušené řízení drážní dopravy	Portál provozování dráhy	Rozsah znalosti viz vnitřní předpis
SŽ D4	Předpis pro řízení drážní dopravy na tratích vybavených radioblokem	Portál provozování dráhy	Rozsah znalosti viz vnitřní předpis
SŽDC D7	Předpis pro operativní řízení provozu	Portál provozování dráhy	Rozsah znalosti viz vnitřní předpis
SŽ D7/2	Organizování výlukových činností	Portál provozování dráhy	Rozsah znalosti viz vnitřní předpis
SŽDC D31	Mimořádné zásilky	Portál provozování dráhy	Rozsah znalosti viz vnitřní předpis
SŽDC D33	Vojenské přepravy	Portál provozování dráhy	Rozsah znalosti viz vnitřní předpis
SŽDC (ČD) D40	Předpis pro organizování drážní dopravy na tratích Liberec - Tanvald - Železný Brod; Tanvald - Harrachov; Smržovka - Josefův Důl	Portál provozování dráhy	Rozsah znalosti viz vnitřní předpis
SŽ Is10	Předpis pro užívání souboru provozních informačních systémů provozovatele dráhy (SPIS)	Portál provozování dráhy	Rozsah znalosti viz vnitřní předpis
SŽDC T1	Telefonní provoz	Portál provozování dráhy	Rozsah znalosti viz vnitřní předpis
SŽDC T7	Rádiový provoz	Portál provozování dráhy	Rozsah znalosti viz vnitřní předpis
SŽ T100	Předpis pro provozování zabezpečovacích zařízení	Portál provozování dráhy	Rozsah znalosti viz vnitřní předpis
SŽDC (ČSD) T108	Obsluha vlakového zabezpečovacího zařízení	Portál provozování dráhy	Rozsah znalosti viz vnitřní předpis
SŽDC (ČD) V65/1	Předpis pro provozování diagnostiky závad jedoucích vozidel	Portál provozování dráhy	Rozsah znalosti viz vnitřní předpis
SŽDC (ČD) Z1	Předpis pro obsluhu staničních a traťových zabezpečovacích zařízení	Portál provozování dráhy	Rozsah znalosti viz vnitřní předpis
SŽDC TR2 (Z1)	Typové rozšíření k předpisu SŽDC (ČD) Z1 Předpis pro obsluhu staničních a traťových zabezpečovacích zařízení - Radioblok	Portál provozování dráhy	Rozsah znalosti viz vnitřní předpis
SŽDC (ČD) Z2	Předpis pro obsluhu přejezdových zabezpečovacích zařízení	Portál provozování dráhy	Rozsah znalosti viz vnitřní předpis
SŽ Z8 díl IV (prozatímní)	Evropský vlakový zabezpečovač ETCS (prozatímní)	Portál provozování dráhy	Rozsah znalosti viz vnitřní předpis
SŽDC (ČD) Z11	Předpis pro obsluhu rádiových zařízení	Portál provozování dráhy	Rozsah znalosti viz vnitřní předpis
Směrnice SŽDC č. 35	kteou se stanovují technické specifikace vlakových rádiových zařízení a zásady pro jejich přípravu a realizaci na železniční dopravní cestě ve vlastnictví státu	Portál provozování dráhy	Rozsah znalosti viz vnitřní předpis

Marking	Name	Link	Comment
Směrnice SŽ SM069	Směrnice pro tvorbu jízdního řádu a přidělování a využívání kapacity dráhy	Portál provozování dráhy	Rozsah znalosti viz vnitřní předpis
Směrnice SŽDC č. 92	Provoz a užívání informačního systému Registr vozidel	Portál provozování dráhy	Rozsah znalosti viz vnitřní předpis
Směrnice SŽ SM071	Protipožární opatření při provozování parních lokomotiv na železniční dopravní cestě, kterou provozuje státní organizace Správa železnic	Portál provozování dráhy	Rozsah znalosti viz vnitřní předpis
Směrnice SŽ SM083	Tvorba a používání Tabulek traťových poměrů Správy železnic	Portál provozování dráhy	Rozsah znalosti viz vnitřní předpis
Směrnice SŽ SM100	Směrnice pro poskytování informací cestujícím ve stanicích a na zastávkách prostřednictvím provozovatele dráhy	Portál provozování dráhy	Rozsah znalosti viz vnitřní předpis
Směrnice SŽ SM103	Řešení ekologických škodních událostí	Portál provozování dráhy	Rozsah znalosti viz vnitřní předpis

Annex "P"

Uniform terms and conditions of the Správa železnic

Jednotné smluvní podmínky

pro provozování drážní dopravy
na celostátní dráze a regionálních dráhách

provozovaných Správou železnic, státní organizací

Preamble

Předmětem těchto Jednotných smluvních podmínek pro provozování drážní dopravy na celostátní dráze a regionálních dráhách (dále též "JSP"), které provozuje Správa železnic, státní organizace (dále též „Správa železnic“), je úprava vzájemných práv a povinností provozovatele drážní dopravy (dále též „dopravce“) oprávněného k provozování drážní dopravy dle Zákona č. 266/1994 Sb., o dráhách (dále též „zákon o dráhách“) a Správy železnic při

- a) přidělování kapacity dráhy na celostátní dráze a regionálních dráhách, na nichž je Správa železnic podle zákona o dráhách přidělcem;
- b) provozování drážní dopravy na celostátní dráze a regionálních dráhách provozovaných Správou železnic;
- c) použití zařízení služeb provozovaných Správou železnic a využití služeb, které bezprostředně souvisí s provozováním drážní dopravy na celostátní dráze nebo regionálních dráhách, poskytovaných Správou železnic.

Správa železnic provozuje celostátní dráhu a regionální dráhy na základě platných a účinných úředních povolení a osvědčení provozovatele dráhy, to vše vydané Drážním úřadem.

Dopravce provozuje drážní dopravu na celostátní dráze a regionálních dráhách na základě a v rozsahu platné a účinné licence k provozování drážní dopravy a osvědčení dopravce, to vše vydané příslušným drážním správním úřadem nebo Agenturou Evropské unie pro železnice.

V souladu se zákonem o dráhách zpracovává a vydává Správa železnic, jako přidělcem, pro každé období ročního jízdního řádu Prohlášení o dráze celostátní a regionální (dále též „prohlášení o dráze“), které zveřejňuje způsobem umožňujícím dálkový přístup. Prohlášení o dráze stanoví, v souladu s právní úpravou, jednotné a nediskriminační podmínky pro přidělování a odebrání kapacity dráhy, pro přístup na dráhu, její užití, pro výpočet ceny za toto užití a uplatnění sankcí za narušení provozování drážní dopravy, které jsou závazné a pro všechny žadatele o kapacitu dráhy společné a shodné. Jakékoli ustanovení těchto JSP je nutno vykládat prostřednictvím a v souladu s prohlášením o dráze.

Kapitola I. Provozování drážní dopravy

Článek 1 Přidělování kapacity dráhy

1. Správa železnic přiděluje kapacitu dráhy dopravci na jeho žádost. Správa železnic a dopravce přitom postupují v souladu se zákonem o dráhách a závazným právem Evropské unie.

2. Správa železnic si vyhrazuje právo odebrat dopravci přidělenou kapacitu dráhy z důvodů uvedených v prohlášení o dráze, stanovených právními předpisy či na základě pravomocného rozhodnutí orgánu veřejné moci.

Článek 2

Jízdní řád a plánování jízd vlaků

1. Každý vlak dopravce jede podle jízdního řádu a před jízdou musí být zaveden do informačních systémů Správy železnic.
2. Žádosti dopravce o přidělení kapacity dráhy a vlakové trasy mohou podávat pouze dopravcem určené osoby.
3. Každá žádost dopravce o přidělení kapacity dráhy a vlakové trasy musí být podána v souladu s podmínkami uvedenými v prohlášení o dráze.
4. Pravidla pro podávání a zpracování žádostí v režimu ad hoc a pro využívání přidělené kapacity dráhy stanoví směrnice SŽ SM069 a prohlášení o dráze.
5. Před jízdou každého vlaku dopravce musí být v souboru provozních informačních systémů Správy železnic (dále též „SPIS“) zavedeny skutečné parametry vlaku a údaje o připravenosti vlaku k odjezdu. Dopravce je proto povinen před odjezdem vlaku z výchozího dopravního bodu a v dalších určených případech předat Správě železnic prostřednictvím SPIS údaje o složení tohoto vlaku a o času, ve kterém bude vlak připraven okamžitě odjet.
6. Podmínky provozu SPIS a kompletní postupy pro zadávání a odesílání informací o vlaku stanovuje předpis SŽ Is10.
7. Dopravce předá v elektronické podobě Správě železnic jmenný seznam osob, které jsou oprávněny podávat jeho jménem žádosti o přidělení kapacity dráhy a vlakové trasy a předávat prostřednictvím SPIS informace týkající se vlaků dopravce. Tento seznam je dopravce povinen v případě jakékoliv změny Správě železnic bezodkladně aktualizovat.
8. Na základě požadavku dopravce umožní Správa železnic datovou výměnu mezi SPIS a certifikovaným informačním systémem dopravce, a to za podmínek uvedených v předpisu SŽ Is10.
9. Správa železnic umožní dopravci přístup k datům z informačního systému Electronic Timetable Display (dále též „ETD“). Dopravce smí data získaná z informačního systému ETD používat výhradně pro svou provozní potřebu a pouze pro účely jejich zpracování, distribuce a zobrazení na zařízeních dopravce nebo na zařízeních hnacích vozidel dopravce, pro účely školení zaměstnanců dopravce a pro užití dispečerským aparátem dopravce.
10. Tabelární jízdní řády vydané na základě žádosti dopravce o přidělení kapacity dráhy a vlakové trasy předává Správa železnic dopravci v elektronické podobě prostřednictvím příslušné aplikace SPIS.

Článek 3

Omezení provozování dráhy

1. Správa železnic organizuje stavební a technologické práce na údržbě, opravě, výstavbě, modernizaci a rekonstrukci železniční infrastruktury tak, aby byl minimalizován případný negativní dopad na rozsah a plynulost železniční dopravy a na oprávněné zájmy dopravce i Správy železnic.
2. V případech omezení provozování dráhy podle tohoto článku umožní Správa železnic dopravci, po vzájemné dohodě a s ohledem na aktuální dopravní situaci, jízdy jeho vlaků v rozsahu podle článku 1 těchto JSP přidělením náhradní kapacity dráhy na plánované trase v náhradních termínech nebo přidělením náhradní kapacity dráhy odklonovou trasou v rámci platné licence, podle podmínek zveřejněných v prohlášení o dráze.
3. Při plánování dočasných omezení kapacity dráhy (dále též „DOK“) postupuje Správa železnic podle podmínek daných platnou právní úpravou a lhůt v ní stanovených. V rámci projednávání DOK Správa železnic stanoví a sdělí dopravci způsob určení vlivu tohoto omezení na provozování dráhy a drážní dopravy, způsob vypořádání případných konfliktů

tras vzniklých v souvislosti s aktivací předmětného DOK a dále předpokládaný způsob organizace výlukové dopravy nebo dopravních opatření, jsou-li Správě železnic s ohledem na stupeň projednávání DOK známy. Správa železnic může po dohodě se všemi zainteresovanými dopravci v konkrétních případech projednávání DOK přistoupit ke kratším lhůtám projednání DOK.

4. Postup při úpravě přidělené kapacity dráhy a přidělení náhradní kapacity dráhy, včetně termínů jednotlivých fází tohoto postupu, zveřejňuje Správa železnic v prohlášení o dráze.
5. Dopravce pro zpracovávání výlukových rozkazů na vyžádání Správy železnic vypracuje dílčí opatření k dopravě, kterou v předmětném úseku provozuje, nebo Správě železnic oznámí, že z pohledu dopravce není nutno dílčí opatření k výlukovému rozkazu zpracovávat. Postupy pro zpracovávání výlukových rozkazů stanoví předpis SŽ D7/2. Pro tyto účely používá dopravce a Správa železnic informační systém Centrální systém výluk (CSV), který Správa železnic zpřístupní určeným zaměstnancům dopravce.
6. V souladu s předpisem SŽ D7/2 zveřejňuje Správa železnic příslušný platný plán DOK na internetovém portálu Správy železnic pro provozování dráhy <https://provoz.spravazeleznic.cz> (dále též „portál“) v termínu stanoveném tímto předpisem.
7. Správa železnic dodržuje zveřejněný plán DOK. Případný požadavek na změnu v tomto plánu, která bude mít vliv na jízdu vlaků dopravce, musí Správa železnic s dopravcem předem projednat.
8. Správa železnic bez zbytečného odkladu prokazatelně oznámí dopravci každé odřeknutí zmocněné výluky.
9. Případný požadavek na změnu v rozsahu a harmonogramu realizované výluky vyvolané činností Správy železnic nebo jejich smluvních partnerů (třetích stran, případně zhotovitelů díla), který má vliv na jízdu vlaků dopravce, je Správa železnic povinna bez zbytečného odkladu prokazatelně oznámit dopravci spolu s odůvodněním, informací o stanoveném novém rozsahu výluky, jakož i o návrhu náhradního opatření pro zajištění provozování drážní dopravy v dotčeném úseku.
10. Mimořádné přerušení provozu na trati nebo jeho výrazné omezení s vlivem na jízdu vlaků dopravce vyšším než 10 minut prokazatelně oznámí Správa železnic dopravci neprodleně po zjištění překážky nebo po rozhodnutí o konání nepředpokládané výluky, a to včetně předpokládané doby trvání přerušení provozu a důvodu či příčiny vzniku mimořádného přerušení provozu.
11. Správa železnic, s ohledem na lhůty předprodeje jízdních dokladů, projedná s dopravcem ve veřejné osobní dopravě i zahájení a dobu trvání předpokládané výluky nezahrnuté v informacích poskytovaných Správou železnic v rámci dlouhodobého plánování výluk v souladu s Rozhodnutím komise v přenesené pravomoci (EU) 2017/2075 a neprojednávané podle § 23b) zákona o dráhách, včetně předpokládaného dopadu výluky do činností dopravce, takto:
 - výluky na trati, na níž je provozována veřejná mezistátní osobní doprava a/nebo veřejná vnitrostátní dálková osobní doprava, v předstihu nejméně 90 kalendářních dnů před zahájením výluky,
 - výluky na ostatních tratích v předstihu nejméně 60 kalendářních dnů.
12. Úhradu oprávněných vícenákladů dopravce souvisejících s jízdou vlaků veřejné osobní dopravy vzniklých v důsledku DOK konaného ve prospěch cizího právního subjektu (dále též „CPS“) zprostředkuje Správa železnic na základě smluvního vztahu Správy železnic s CPS. Vyúčtování vícenákladů předloží dopravce Správě železnic formou daňového dokladu nejpozději do 5. dne druhého měsíce následujícího po měsíci, kdy byly související výluky ukončeny. Tento doklad Správa železnic přiloží do celkové fakturace vůči CPS. Pro úhradu platí doba splatnosti uvedená v článku 14 těchto JSP obdobně.
13. Správa železnic v případě omezení provozování dráhy s nutností zavedení náhradní dopravy za vlaky veřejné osobní dopravy zabezpečí v místech jí spravovaných železničních stanic a zastávek označení zastávek náhradní dopravy.

14. Správa železnic zajistí v železničních stanicích a zastávkách zveřejnění informací pro cestující o termínech výluk, a to u předpokládaných výluk nejpozději 5 dnů před jejich zahájením, u nepředpokládaných výluk, které jsou oznámeny v předstihu alespoň 48 hodin, pak nejpozději den před jejich zahájením.

Článek 4 **Předpisové podmínky**

1. Dopravce je povinen:
 - a) dodržovat vnitřní předpisy provozovatele dráhy uvedené v příloze 1 smlouvy o provozování drážní dopravy uzavřené mezi Správou železnic a dopravcem (dále též „smlouva o PDD“) a v příloze „O“ prohlášení o dráze,
 - b) respektovat údaje tabulek traťových poměrů,
 - c) dodržovat ustanovení základní dopravní dokumentace,
 - d) dodržovat ustanovení pohraničních ujednání při přechodu na dráhy na území sousedních států.
2. Ve vztahu k přepravovaným věcem dopravce respektuje kromě obecně platných právních norem pro ochranu životního prostředí i Řád pro mezinárodní železniční přepravu nebezpečných věcí (RID – Přípojek C k úmluvě COTIF).
3. Dopravce nese odpovědnost za závady v ložení a zajištění přepravovaných věcí, které ohrožují nebo narušují bezpečnost drážní dopravy, bezpečnost osob, bezpečnou funkci staveb nebo zařízení nebo životní prostředí. Správa železnic není povinna správnost ložení přepravovaných věcí a jejich zajištění kontrolovat, zjistí-li však takovéto závady v ložení a zajištění přepravovaných věcí, je oprávněna odmítnout jízdu z důvodu vadně loženého vlaku nebo vozu.
4. Správa železnic je povinna umožnit dopravci přístup na portál k elektronické podobě:
 - a) svých vnitřních předpisů podle bodu 1 písm. a) tohoto článku,
 - b) tabulek traťových poměrů,
 - c) základní dopravní dokumentace,
 - d) pohraničních ujednání,
 - e) dalších výnosů a opatření nezbytných k provozování drážní dopravy,včetně jejich změn.
5. S výjimkou případů bezprostředně ohrožujících plynulé a bezpečné provozování dráhy a drážní dopravy Správa železnic zveřejňuje všechny dokumenty a jejich změny podle bodu 4. tohoto článku v dostatečném předstihu, nejméně však 21 kalendářních dnů před nabytím jejich účinnosti, aby dopravce mohl dostát svým závazkům z nich vyplývajícím. V případě nesplnění této povinnosti Správa železnic nenesे dopravce odpovědnost za porušení dotčených ustanovení bodu 1. tohoto článku a za následky takového porušení včetně újmy vzniklé v přímé souvislosti s nesplněním této povinnosti Správě železnic a/nebo třetím osobám.
6. Dopravce je povinen včas se seznámit se zveřejněnými dokumenty podle bodu 4. tohoto článku a vyzoomět o nich své zaměstnance.
7. Na změny dokumentů podle bodu 4. tohoto článku je Správa železnic povinna dopravce upozornit prostřednictvím elektronické pošty na dopravcem určenou e-mailovou adresu (tzv. Novinky s potvrzením). Dopravce je povinen kliknutím na příslušný odkaz potvrdit skutečnost, že vzal tyto změny na vědomí.
8. Údaje převzaté z portálu může dopravce použít výhradně pro svou provozní potřebu. Poskytování dat jiným subjektům a jejich použití pro jiné než provozní účely se považuje za porušení smlouvy o PDD a těchto JSP, ledaže jde o plnění zákonné povinnosti či pro účely řízení před orgány veřejné moci nebo na základě jejich pravomocného rozhodnutí.
9. Pomůcky k jízdnímu řádu v tištěné podobě (jsou-li ze strany Správy železnic vydávány) je dopravce oprávněn objednat na portálu svým určeným zaměstnancem, kterému Správa

železnic umožní přístup k příslušné aplikaci. Ceny těchto pomůcek k jízdniému řádu a jejich změn se stanoví podle výše nákladů na tisk a distribuci. Ostatní pomůcky k jízdniému řádu vydávané Správou železnic pro potřeby dopravce v elektronické podobě zveřejňuje Správa železnic na portálu.

Článek 5 Zaměstnanci dopravce

1. Na základě licence udělené dopravci jsou zaměstnanci dopravce oprávněni vstupovat do celé sítě provozované železniční dopravní cesty. Pro vstup musí být vybaveni průkazy zaměstnance dopravce, příp. jiným dokladem tyto průkazy nahrazujícím, s opravňující doložkou uvedenou v českém jazyce.
2. Dopravce odpovídá za odbornou a zdravotní způsobilost svých zaměstnanců podle zákona o dráhách.
3. Zaměstnanci dopravce jsou povinni uposlechnout pokynů, které dávají v zájmu zachování bezpečnosti a plynulosti provozu zaměstnanci Správy železnic, jejichž pracovní činnost přímo souvisí s provozováním dráhy a organizováním drážní dopravy. V případě ohrožení bezpečnosti osob nebo majetku mohou tito zaměstnanci Správy železnic další činnost zaměstnanců dopravce nebo další provoz na nezbytně nutnou dobu zastavit. O tomto postupu a jeho důvodech Správa železnic dopravce neprodleně informuje.
4. Zaměstnanci dopravce v prostorech veřejnosti nepřístupných a zaměstnanci dopravce při výkonu dopravní služby musí na požádání oprávněných zaměstnanců Správy železnic předložit průkaz zaměstnance dopravce. Na požádání zaměstnanců Správy železnic ve výkonu pracovní činnosti, kteří se prokáží průkazem nehodové pohotovosti nebo průkazem s oprávněním ke kontrolní činnosti na úseku řízení provozu a provozování dráhy, se osoby řídící drážní vozidlo navíc prokáží osvědčením strojvedoucího a licencí strojvedoucího. Členové obsluhy vlaku osobní dopravy musí mít viditelné služební označení, jehož podobu oznámí dopravce Správě železnic.
5. Správa železnic si vyhrazuje právo zabránit ve výkonu práce zaměstnancům dopravce, u nichž zjistí závažné důvody bránící jim v bezpečném výkonu práce (porušení předpisů pro provoz na celostátní dráze a regionálních dráhách, podezření z práce pod vlivem alkoholu či jiných návykových látek, neplatnost průkazu zaměstnance dopravce, osvědčení strojvedoucího nebo licence strojvedoucího, neschopnost prokázat se těmito doklady ap.). O tomto postupu Správa železnic dopravce neprodleně informuje.
6. Dopravce předá v elektronické podobě Správě železnic seznam svých určených zaměstnanců a jejich kontaktních údajů pro účely oznamování mimořádných událostí a komunikace v rámci operativního řízení drážní dopravy, řízení přístupů do SPIS, potvrzování změn dokumentů na portálu, projednávání DOK, objednávání využití zařízení služeb nebo služby a řešení kvality datové výměny. Tento seznam je dopravce povinen v případě jakékoliv změny Správě železnic bezodkladně aktualizovat.
7. Ve vztahu k osobním údajům zaměstnanců dopravce předávaným podle smlouvy o PDD a/nebo těchto JSP má Správa železnic postavení dalšího správce, nikoliv zpracovatele.

Článek 6 Drážní vozidla

1. Dopravce poskytuje Správě železnic údaje o jím používaných drážních vozidlech povolených k provozu na celostátní dráze a regionálních dráhách provozovaných Správou železnic. Pro tyto účely Správa železnic dopravci zpřístupní na portálu informační systém Registr vozidel (dále též „REVOZ“). Dopravce vkládá do informačního systému REVOZ aktuální údaje o hnacích vozidlech, elektrických a motorových jednotkách, speciálních hnacích vozidlech a jakýchkoli drážních vozidlech, zejména těch, která z důvodu své konstrukce či pevné výbavy vyžadují uplatnění zvláštních cen za použití dráhy nebo za spotřebu trakční elektrické energie, a o všech vozidlech, která nemají ukončen schvalovací proces pro celou železniční síť České republiky. Poskytnuté údaje budou sloužit pro potřeby Správy železnic a ke kalkulaci ceny za použití dráhy jízdou vlaku nebo ceny za spotřebu trakční elektrické energie. Správa železnic umožní dopravci k takto poskytnutým údajům trvalý přístup.

Pravidla pro provozování informačního systému REVOZ a práva a povinnosti jeho uživatelů stanoví Směrnice SŽDC č. 92.

2. Dopravce je při označování drážních vozidel povinen používat jednoznačnou identifikaci podle obecně závazných právních předpisů Evropské unie a České republiky. Při označování hnacích vozidel respektuje též ČSN 28 0082 „Kolejová vozidla železniční - Číselné označování hnacích kolejových vozidel“, kromě vnějšího označení historických vozidel, nestanoví-li rozhodnutí Drážního úřadu, mezinárodní smlouva nebo závazné právo Evropské unie jinak. Pro účely předávání informací o vozidlech vlaku a záznamů o jednotlivých vozidlech v informačním systému REVOZ musí dopravce používat plné dvanáctimístné číselné označení vozidel. Vozidlům, která dvanáctimístné číselné označení nemají, zajistí dopravce jeho přidělení prostřednictvím Drážního úřadu. Případné výjimky povoluje Správa železnic; Správa železnic není oprávněna bezdůvodně odmítnout poskytnutí výjimky.
3. Dopravce odpovídá za to, že všechna jím používaná drážní vozidla splňují podmínky stanovené pro provozování drážních vozidel zákonem o dráhách, vyhláškou č. 173/1995 Sb., kterou se vydává dopravní řád drah, a z těchto obecně platných norem vycházejících vnitřních předpisů dopravce (pravidelná technická kontrola, vykonané prohlídky a zkoušky brzd ap.).
4. Dopravce odpovídá za přechodnost drážních vozidel na použité dráze.
5. Při použití parních lokomotiv je dopravce povinen zajistit požární bezpečnost a dodržovat Směrnici SŽ SM071.
6. V případě použití hnacích vozidel elektrické trakce je dopravce povinen sjednat s poskytovatelem trakční elektrické energie, který je uveden v prohlášení o dráze, podmínky jejího odběru samostatným smluvním ujednáním. Toto samostatné smluvní ujednání musí být účinné nejpozději dnem, kdy dopravce hnací vozidlo elektrické trakce poprvé použije.
7. Při použití hnacích vozidel elektrické trakce je ve Správě železnic určených traťových úsecích při brzdění dovoleno použití rekuperace. Dopravce je v tomto případě povinen dodržovat vztahná ustanovení vnitřních předpisů Správy železnic a dále podmínky stanovené Správou železnic vydanými pokyny k provozu rekuperace na příslušné trakční proudové soustavě. Pokyny k provozu rekuperace zveřejňuje Správa železnic dopravci v souladu s článkem 4 těchto JSP na portálu.
8. Specifikace rádiových systémů pro dodržování předpisu SŽDC (ČD) Z11 je uvedena v prohlášení o dráze.
9. K zajištění bezpečného provozování drážní dopravy používá Správa železnic indikátory síťového diagnostického systému železničních vozidel, které indikují závady na jedoucích železničních vozidlech. Podmínky provozu indikátorů a postup při indikaci závad stanoví předpis SŽDC (ČD) V65/1.

Článek 7 Mimořádné zásilky

1. Mimořádné zásilky je dopravce povinen předem projednat s oddělením URMIZA (ústřední registr mimořádných zásilek) Správy železnic v plném rozsahu podle předpisu SŽDC D31.
2. Ceny za projednání a zveřejnění podmínek přepravy mimořádné zásilky jsou zveřejněny v souladu s prohlášením o dráze.

Článek 8 Omezení jízdy vlaků

1. Správa železnic a dopravce organizují provoz vlaků dopravce po sjednané trase tak, aby doprava vlaků probíhala bezpečně a s dodržením platného jízdního řádu. Správa železnic a dopravce jsou povinni bez zbytečného odkladu se vzájemně informovat o jakékoliv skutečnosti mající vliv na bezpečný a plynulý provoz.

2. Dojde-li k omezení jízdy vlaku dopravce, nezaviněnému Správou železnic, poskytne Správa železnic dopravci všechny dostupné podklady, jimiž sama disponuje, a které jsou potřebné pro prokázání odpovědnosti za toto omezení.
3. Dopravce uhradí Správě železnic její prokazatelné náklady vzniklé v přímé souvislosti s odvozem uvázaného vlaku dopravce v případech, kdy odvoz tohoto vlaku do místa odstavení zajistí Správa železnic hnacím vozidlem jiného dopravce.
4. Správa železnic uhradí dopravci jeho prokazatelné náklady vzniklé v přímé souvislosti s odvozem uvázaného vlaku jiného dopravce v případech, kdy odvoz tohoto vlaku do místa odstavení zajistí Správa železnic hnacím vozidlem dopravce.
5. V případě odvozu uvázaného posunového dílu platí ustanovení bodu 3. nebo 4. tohoto článku obdobně.

Článek 9 Mimořádné události

1. Dopravce je povinen bezodkladně ohlásit na příslušné ohlašovací pracoviště Správy železnic:
 - vznik mimořádných událostí podle § 49 zákona o dráhách, které zjistil sám nebo se o nich věrohodně dozvěděl;
 - vznik pracovních úrazů podle zákona č. 262/2006 Sb., zákoníku práce, a nařízení vlády č. 201/2010 Sb., o způsobu evidence úrazů, hlášení a zasílání záznamu o úrazu, souvisejících s provozováním dráhy či drážní dopravy, pokud má na nich účast.

Potřebné kontaktní údaje jsou uvedeny na portálu.

2. Při vzniku mimořádné události v drážní dopravě postupují Správa železnic a dopravce v souladu s vyhláškou č. 376/2006 Sb., o systému bezpečnosti provozování dráhy a drážní dopravy a postupech při vzniku mimořádných událostí na dráhách.
3. Odstraňování následků mimořádné události řídí Správa železnic. Na její požádání je dopravce povinen vypomáhat svým zařízením a odborně způsobilými zaměstnanci. Náklady na odstraňování následků mimořádné události se považují za součást škody.
4. Pracovní úrazy vzniklé v souvislosti s provozováním dráhy či drážní dopravy se šetří podle zákona č. 262/2006 Sb., zákoníku práce, a nařízení vlády č. 201/2010 Sb., o způsobu evidence úrazů, hlášení a zasílání záznamu o úrazu, a šetří je příslušný zaměstnavatel (Správa železnic nebo dopravce), ve spolupráci s druhou smluvní stranou smlouvy o PDD.

Kapitola II Zpoplatnění výkonů a služeb

Článek 10 Ceny za přidělení kapacity dráhy

1. Za přidělení kapacity dráhy uhradí dopravce Správě železnic ceny uvedené v prohlášení o dráze.
2. Pravidla pro využití přidělené kapacity dráhy a postup v případě jejího nevyužití jsou uvedeny v prohlášení o dráze.

Článek 11 Ceny za použití dráhy

1. Za použití dráhy jízdou vlaku uhradí dopravce Správě železnic ceny uvedené v prohlášení o dráze.
2. Zpoplatnění použití dráhy podléhají všechny jízdy vlaků v rámci provozování drážní dopravy na celostátní dráze a regionálních dráhách, a to za podmínek uvedených v těchto JSP.

3. Zpoplatnění použití dráhy nepodléhá:
 - a) jízda drážních vozidel při posunu,
 - b) jízda drážních vozidel z přilehlé stanice na vyloučenou kolej nebo na pracovní místo na trati a zpět do přilehlé stanice.

Článek 12

Zařízení služeb a ceny za poskytnuté služby

1. Správa železnic umožní dopravci použití zařízení služeb provozovaných Správou železnic a využití služeb, které bezprostředně souvisí s provozováním drážní dopravy na celostátní nebo regionální dráze, poskytovaných Správou železnic. Podmínky pro využití těchto zařízení služeb a služeb zveřejňuje Správa železnic v souladu s platnou legislativou v popisu zařízení služeb. Popisy zařízení služeb zveřejňuje Správa železnic na portálu. Objednávku mohou podávat pouze dopravcem určené osoby. Poskytnutí služby může být podmíněno uzavřením samostatné smlouvy.
2. Informace o cenách za použití zařízení služeb a za služby bezprostředně související s provozováním drážní dopravy na celostátní nebo regionální dráze zveřejňuje Správa železnic v popisu zařízení služeb.
3. Cena za doplňkovou službu spočívající v dodávce trakční elektrické energie je předmětem samostatného smluvního ujednání dle článku 6 bodu 6. těchto JSP.

Článek 13

Evidence výkonů a služeb

1. Správou železnic je dopravci pro potřeby číselné identifikace přiděleno šestimístné evidenční číslo, které je v rámci SPIS jedinečné.
2. Pro kalkulaci cen za přidělení kapacity dráhy používá Správa železnic podklady z informačních systémů, které jsou součástí SPIS. Odsouhlasování přidělené kapacity dráhy provádějí určení zaměstnanci Správy železnic a dopravce podle pravidel uvedených v předpisu SŽ Is10.
3. Pro kalkulaci cen za použití dráhy jízdou vlaku a sankcí za nevyužití nebo odřeknutí přidělené kapacity dráhy používá Správa železnic informační systém KAPO, který je součástí SPIS. Tento systém na základě údajů z dalších (zdrojových) informačních systémů v rámci SPIS eviduje výkony dopravce, provádí jejich ocenění podle ustanovení prohlášení o dráze a vytváří výstupní doklady sloužící jako podklad pro fakturaci.
4. Odsouhlasování evidovaných výkonů provádějí určení zaměstnanci Správy železnic a dopravce prostřednictvím elektronických výstupů z informačního systému KAPO (pracovního dodacího listu nebo webové aplikace) podle pravidel uvedených v prohlášení o dráze a v předpisu SŽ Is10.
5. Pro stanovení ujeté vzdálenosti jsou určující údaje číselníků jednotného popisu sítě Správy železnic zveřejněné na portálu v aplikaci DYPOD.
6. V případě, že dopravce nedodržel ustanovení uvedená v předpisu SŽ Is10 a nedoručil do SPIS kompletní informace o celkové hmotnosti vlaku potřebné k výpočtu ceny za užití dráhy tímto vlakem, použije Správa železnic při výpočtu celkovou hmotnost vlaku 5 000 t.
7. Správa železnic zasílá dopravci spolu s daňovým dokladem sumární přehled ve formátu PDF, z něž jsou zřejmé ceny výkonů realizovaných v rámci jednotlivých produktových faktorů. Sumární přehled je výstupem z informačního systému KAPO a je generován z odsouhlaseného dodacího listu.
8. Kalkulaci cen za použití zařízení služeb a za využití služeb bezprostředně souvisejících s provozováním drážní dopravy na celostátní nebo regionální dráze provádí Správa železnic na základě předem odsouhlasené objednávky dopravce. Předmětné postupy jsou součástí cenových podmínek zveřejněných Správou železnic v souladu s prohlášením o dráze.
9. Správa železnic a dopravce určí odpovědné zástupce pro řešení sporných případů v evidenci výkonů a služeb a sdělí si je včetně kontaktních údajů a případných změn.

Článek 14 Fakturace

1. Cenu za přidělenou kapacitu dráhy fakturuje Správa železnic do 15 kalendářních dnů po skončení kalendářního měsíce, v němž byla kapacita dráhy přidělena. Sankci za nevyužitou nebo odřeknutou přidělenou kapacitu dráhy fakturuje Správa železnic čtvrtletně, tzn. po skončení příslušného čtvrtletí, v němž byla přidělená kapacita nevyužita nebo odřeknuta. Cenu za použití dráhy jízdou vlaku fakturuje Správa železnic do 15 kalendářních dnů po skončení kalendářního měsíce, v němž byla jízda příslušného vlaku ukončena. Dopravce uhradí fakturované částky na účet Správy železnic s použitím variabilního symbolu uvedeného na daňovém dokladu.
2. V mimořádném případě, kdy z důvodu výpadku informačních systémů Správy železnic nebude mezi Správou železnic a dopravcem možné do 10. dne po uplynutí příslušného kalendářního měsíce, v němž byly výkony dopravce na železniční dopravní cestě provedeny, postupovat v odsouhlasení ceny za použití dráhy jízdou vlaku dle pravidel uvedených v předpisu SŽ Is10, vystaví Správa železnic daňový doklad za cenu za použití dráhy jízdou vlaku na částku ve stejné výši, která byla uplatněna za předchozí vzájemně odsouhlasené období (kalendářní měsíc). Po obnovení funkčnosti informačních systémů provedou Správa železnic a dopravce neprodleně dodatečné odsouhlasení ceny za použití dráhy jízdou vlaku, po němž vystaví Správa železnic dopravci do 3 pracovních dnů opravný daňový doklad.
3. Ceny za použití zařízení služeb a za služby bezprostředně související s provozováním drážní dopravy na celostátní nebo regionální dráze fakturuje Správa železnic samostatně.
4. Náklady vzniklé v přímé souvislosti s odvozem uvázlého vlaku nebo posunového dílu ve smyslu článku 8 bodu 3. těchto JSP fakturuje Správa železnic do 15 kalendářních dnů po obdržení faktury od jiného dopravce, jehož hnací vozidlo bylo k tomuto odvozu použito. Dopravce uhradí fakturovanou částku na účet Správy železnic s použitím variabilního symbolu uvedeného na daňovém dokladu.
5. Náklady vzniklé v přímé souvislosti s odvozem uvázlého vlaku nebo posunového dílu ve smyslu článku 8 bodu 4. těchto JSP fakturuje dopravce do 15 kalendářních dnů po uplynutí kalendářního měsíce, v němž byl odvoz uvázlého vlaku nebo posunového dílu uskutečněn. Správa železnic uhradí fakturovanou částku na účet dopravce s použitím variabilního symbolu uvedeného na daňovém dokladu.
6. Splatnost daňových dokladů dle bodů 1. až 5. tohoto článku činí 30 kalendářních dnů. V případě prodloužení s úhradou fakturovaných částek je příslušný plátce (Správa železnic nebo dopravce) povinen kromě dlužné částky uhradit dodavateli i úrok z prodloužení ve výši dané platnou právní úpravou.
7. Daňový doklad, který obsahuje nesprávné nebo neúplné údaje je plátce oprávněn vrátit k opravě do 10 pracovních dnů od jeho doručení, v takovém případě počíná lhůta splatnosti daňového dokladu běžet až dnem, kdy je plátcovi doručen řádně opravený daňový doklad.
8. Neuhradí-li dopravce částky fakturované dle bodu 1. až 3. tohoto článku ve lhůtě podle bodu 6. tohoto článku, vyhrazuje si Správa železnic právo po předchozím písemném upozornění odebrat dopravci již přidělenou kapacitu dráhy a neumožnit mu předkládání dalších požadavků na přidělení kapacity dráhy, a to do doby úhrady dlužných částek.
9. Stane-li se Správa železnic nespolehlivým plátcem nebo daňový doklad Správy železnic bude obsahovat číslo účtu, na který má být plněno, aniž by bylo uvedeno ve veřejném registru spolehlivých účtů, je dopravce oprávněn z finančního plnění uhradit daň z přidané hodnoty přímo věcně a místně příslušnému správci daně Správy železnic.
10. Stane-li se dopravce nespolehlivým plátcem nebo daňový doklad dopravce bude obsahovat číslo účtu, na který má být plněno, aniž by bylo uvedeno ve veřejném registru spolehlivých účtů, je Správa železnic oprávněna z finančního plnění uhradit daň z přidané hodnoty přímo věcně a místně příslušnému správci daně dopravce.
11. Správa železnic a dopravce nejsou oprávněni provést úhradu daňových dokladů podle tohoto článku formou jednostranného zápočtu.
12. Úřední měnou pro účtování a platby dle těchto JSP je koruna česká.

13. Správa železnic a dopravce jsou povinni si vzájemně poskytovat potřebné podklady a informace pro řádné a včasné plnění závazků vyplývajících ze smlouvy o PDD a těchto JSP.
14. Dopravce smí využívat pro zasílání daňových dokladů Správě železnic pouze jednu z uvedených možností:
 - a) v elektronické podobě výlučně na e-mailovou adresu:
ePodatelnaCFU@spravazeleznic.cz
 - b) v elektronické podobě datovou zprávou na identifikátor datové schránky:
uccchjm
 - c) v listinné podobě na adresu:
Správa železnic, státní organizace
Centrální finanční účtárna Čechy
Náměstí Jana Pernera 217, 530 02 Pardubice
15. Správa železnic zasílá dopravci daňové doklady v listinné podobě na adresu sídla společnosti dopravce (případně na dopravcem určenou fakturační adresu) nebo v elektronické podobě na e-mailovou adresu, oznámenou dopravcem na předepsaném formuláři, doručeném Správě železnic. Formulář je uveřejněn na webových stránkách Správy železnic (<https://www.spravazeleznic.cz/o-nas/vnitri-predpisy-spravy-zeleznic>).
16. V případě zasílání daňových dokladů v elektronické podobě (formát PDF) vystavují Správa železnic a dopravce daňové doklady v souladu se zákonem č. 235/2004 Sb., o dani z přidané hodnoty. Při zasílání daňových dokladů v elektronické podobě nebudou tyto zasílány současně v listinné podobě.

Kapitola III **Další podmínky**

Článek 15

Odpovědnost za škody nebo jiné újmy

1. Správa železnic a dopravce organizují pohyb a pobyt vozidel na dráze tak, aby nedocházelo ke škodám na majetku, k ohrožení životního prostředí, k újmám na životech nebo zdraví osob nebo k jiným újmám, a aby nebyly poškozovány oprávněné zájmy Správy železnic, dopravce ani třetích osob. Správa železnic a dopravce si vzájemně poskytují potřebnou součinnost.
2. Dopravce nese odpovědnost za újmy, které vzniknou Správě železnic nebo třetím osobám, zapříčiněné jeho provozováním drážní dopravy a zapříčiněné jeho provozováním drážních vozidel včetně újmy ze střetu s vozidly jiných dopravců.
3. Správa železnic nese odpovědnost za újmy vzniklé dopravci v souvislosti s provozováním dráhy, vyjma těch, které dopravci vznikly v souvislosti s omezením provozování dráhy, pokud toto omezení bylo realizováno v souladu s platnou právní úpravou nebo dle pravomocného rozhodnutí orgánu veřejné moci. Tím není dotčen nárok dopravce podle § 36 odst. 2 zákona o dráhách.
4. Právo Správy železnic a dopravce na náhradu újmy není dotčeno uplatněním nároku na úhradu sjednaných smluvních sankcí.
5. Dopravce je povinen mít uzavřenou platnou a účinnou pojistnou smlouvu o pojištění své odpovědnosti za újmy způsobené provozováním drážní dopravy, a to tak, aby bylo zajištěno pojistné plnění za každou pojistnou událost minimálně ve výši stanovené v prohlášení o dráze. Na požádání je povinen předložit Správě železnic platnou a účinnou pojistnou smlouvu nebo pojišťovnou vydaný doklad o platném pojištění k ověření trvání tohoto pojištění. Nesplní-li tyto povinnosti ani po opakované výzvě, je Správa železnic oprávněna odstoupit od smlouvy o PDD a účinnost smlouvy o PDD zaniká dnem následujícím po dni doručení oznámení dopravci o odstoupení.

Článek 16 Sankce za narušení provozování drážní dopravy

1. Správa železnic a dopravce jsou povinni dodržovat systém sankcí za narušení provozování drážní dopravy stanovený Správou železnic v prohlášení o dráze, podmínky pro uplatnění sankcí z tohoto systému a výši těchto sankcí. Správa železnic a dopravce jsou povinni každé uplatnění sankce z tohoto systému předem vzájemně projednat.
2. Správa železnic a dopravce si předávají podrobné informace o narušení provozování drážní dopravy prostřednictvím SPIS. Do sankčního režimu jsou zahrnuty vlaky uvedené v prohlášení o dráze. Vyhodnocování a kalkulace narušení provozování drážní dopravy probíhá ve dvou fázích:

C. Vyhodnocování jednotlivých jízd dopravce, výpočet výše sankce:

- e. každý vlak daného dopravce zahrnutý do sankčního režimu je vyhodnocován samostatně;
- f. u každého vlaku se sečtou zvláště přírůstky zpoždění vzniklé po dobu jízdy vlaku z odpovědnosti Správy železnic a zvláště přírůstky zpoždění vzniklé po dobu jízdy vlaku z odpovědnosti dopravce. Přírůstky zpoždění vzniklé po dobu jízdy vlaku z ostatních příčin se nezohledňují;
- g. výše sankce se vypočítá jako sazba za minutu zpoždění vynásobená kladným rozdílem mezi sumou přírůstků zpoždění vzniklých po dobu jízdy vlaku z odpovědnosti jedné strany (Správy železnic nebo dopravce) a sumou přírůstků zpoždění vzniklých po dobu jízdy vlaku z odpovědnosti druhé (opačné) strany;
- h. kalkulačním obdobím je kalendářní měsíc. Účetním obdobím je jeden kalendářní rok.

D. Vyhodnocování všech jízd dopravce, stanovení míry odpovědnosti:

- a) počet vlaků dopravce zahrnutých v sankčním režimu je porovnán s celkovým počtem vlaků dopravce (tj. počtem vlaků celkem z informačního systému KAPO pro účely stanovení ceny za použití dráhy jízdou vlaku pro daný kalendářní měsíc);
- b) pokud je počet vlaků zahrnutých v sankčním režimu vyšší nebo roven 20 % z celkového počtu vlaků, uhradí ta strana, která je odpovědná za 60 a více % minut všech přírůstků zpoždění všech vlaků zahrnutých do sankčního režimu v daném kalendářním měsíci, druhé straně sankci. Pro uplatnění sankce musí být splněny obě limitující podmínky;
- c) kalkulačním obdobím je kalendářní měsíc. Účetním obdobím je jeden kalendářní rok.

Sazby sankcí dle předcházejících bodů A. a B. jsou uvedeny v prohlášení o dráze.

3. V případě vzniku sporu ve věci uplatnění sankce za narušení provozování drážní dopravy se Správa železnic a dopravce nejdříve pokusí nalézt shodu smírnou cestou. Sporné případy jsou Správou železnic průběžně předávány arbitrovi uvedenému v prohlášení o dráze. Lhůta pro řešení sporných případů arbitrem je 10 pracovních dnů. Podrobný technický postup řešení sporných případů je uveden v prohlášení o dráze.
4. Správa železnic uhradí arbitrovi za každý rozhodnutý sporný případ sankci dle prohlášení o dráze. V případě že je sporný případ rozhodnutý arbitrem ve prospěch Správy železnic, uhradí tutéž sankci dopravce Správě železnic. Pokud rozhodnutí arbitra není ve prospěch dopravce nebo Správy železnic jednoznačné, uhradí dopravce Správě železnic jen 1/2 této sankce. Pokud arbitr z vlastní viny sporný případ ve lhůtě 10 pracovních dnů nerozhodne, arbitr uhradí Správě železnic sankci ve výši dvojnásobku sankce dle prohlášení o dráze a Správa železnic uhradí 1/2 z této částky dopravci. Kalkulačním obdobím je kalendářní měsíc.
5. Pokud arbitr sporný případ ve lhůtě 10 pracovních dnů nerozhodne bez vlastního zavinění, žádná sankce se nehradí. Arbitr je však v takovém případě povinen doložit Správě železnic i dopravci důvody, které mu znemožnily vydat rozhodnutí.

6. Pokud Správa železnic nebo dopravce nebude s rozhodnutím arbitra souhlasit, nebo se Správa železnic a dopravce na uplatnění sankce nejpozději do 10 pracovních dnů po doručení vyrozumění o sporu arbitrovi neshodnou, nebo marně uplyne lhůta pro doručení rozhodnutí o sporu vydaného příslušným arbitrem, může být spor jednou z jeho stran předložen k řešení příslušnému soudu České republiky.
7. Vzájemně projednané sankční částky vyplývající ze sankčního systému fakturují Správa železnic a dopravce do 15. dne čtvrtého kalendářního měsíce po skončení kalendářního měsíce, ve kterém důvod k uplatnění sankce vznikl. Daňový doklad zahrnuje celkovou výslednou cenu za všechny odsouhlasené sankce v příslušném kalendářním měsíci. Fakturovaná částka se hradí na účet příslušné strany s použitím variabilního symbolu uvedeného na daňovém dokladu. Splatnost daňového dokladu je 30 kalendářních dnů. V případě prodlení s úhradou fakturované částky je příslušný plátcе sankce povinen uhradit kromě dlužné částky i úrok z prodlení ve výši dané platnou právní úpravou.
8. Správa železnic a dopravce nejsou oprávněni provést úhradu sankcí za narušení provozování drážní dopravy formou jednostranného zápočtu.

Článek 17

Ukončení smlouvy o PDD uzavřené mezi Správou železnic a dopravcem

1. Smlouva o PDD je standardně uzavírána na dobu neurčitou. Ukončení platnosti a účinnosti této smlouvy lze pak provést následujícími způsoby:
 - a) písemnou dohodou smluvních stran;
 - b) písemnou výpovědí kteroukoliv ze smluvních stran. Výpovědní doba činí 3 měsíce a počíná běžet prvním dnem kalendářního měsíce následujícího po doručení výpovědi druhé smluvní straně. Pokud však dopravce nejpozději do konce prvního měsíce výpovědní doby písemně požádá Správu železnic o uzavření nové smlouvy o PDD, je Správa železnic povinna dopravci zaslat do 15 kalendářních dnů od obdržení této žádosti návrh nové smlouvy o PDD. Nedojde-li mezi dopravcem a Správou železnic k dohodě o obsahu nové smlouvy o PDD do konce výpovědní doby dosavadní smlouvy o PDD a zároveň požádá-li kterákoli ze smluvních stran Úřad pro přístup k dopravní infrastruktuře (dále též „ÚPDI“) před koncem výpovědní doby dosavadní smlouvy o PDD, aby rozhodl o obsahu nové smlouvy o PDD ve smyslu ustanovení § 34g odst. 6) zákona o dráhách, pak platí, že výpovědní doba dosavadní smlouvy o PDD se staví a neběží ode dne, kdy byla prokazatelně odeslána tato žádost o rozhodnutí ÚPDI, a skončí nejdříve 15 kalendářních dnů po dni, kdy nabylo právní moci rozhodnutí ÚPDI dle ustanovení § 34g odst. 6) zákona o dráhách;
 - c) písemným odstoupením od smlouvy jednou ze smluvních stran, ztratí-li Správa železnic způsobilost k provozování celostátní dráhy a regionálních drah, které jsou předmětem smlouvy o PDD, nebo ztratí-li dopravce způsobilost k provozování drážní dopravy na celostátní dráze a regionálních dráhách, které jsou předmětem smlouvy o PDD. Odstoupení od smlouvy nabývá účinnosti v den následující po dni jeho doručení druhé smluvní straně nebo v den, kterým je v předstihu stanovena drážním správním orgánem ztráta této způsobilosti Správy železnic nebo dopravce.
2. Správa železnic si dále vyhrazuje právo ukončit smlouvu o PDD cestou odstoupení od smlouvy také v případě dle článku 15 bodu 5. těchto JSP.
3. Správa železnic a dopravce jsou povinni do 30 kalendářních dnů po skončení smluvního vztahu vypořádat vzájemné závazky.

Článek 18

Ostatní ustanovení

1. Ke dni účinnosti smlouvy o PDD se ruší veškerá případná ujednání a dohody, které by se týkaly shodného předmětu plnění a tyto jsou v plném rozsahu nahrazeny ujednáními obsaženými ve smlouvě o PDD a/nebo v těchto JSP, tj. neexistuje žádné jiné ujednání, které by smlouvu o PDD a/nebo JSP doplňovalo nebo měnilo.
2. Jakékoliv písemnosti předvídané ve smlouvě o PDD a/nebo v těchto JSP musí být učiněny, není-li ve smlouvě o PDD a/nebo v JSP nebo v nich uvedených závazných dokumentech

výslovně stanoveno jinak, písemně v listinné podobě a musí být s vyloučením ustanovení § 566 zákona č. 89/2012 Sb., občanského zákoníku (dále též „občanský zákoník“), řádně podepsány oprávněnými osobami. Jakékoliv jiné písemnosti, včetně e-mailové korespondence, jsou bez právního významu, není-li ve smlouvě o PDD a/nebo v těchto JSP výslovně stanoveno jinak. Na roveň písemné listinné podobě je postavena komunikace prostřednictvím datové schránky v souladu se zákonem č. 300/2008 Sb., o elektronických úkonech a autorizované konverzi dokumentů.

3. Veškeré změny nebo doplnění smlouvy o PDD musí být učiněny formou písemného dodatku podepsaného oprávněnými zástupci obou smluvních stran, jinak je taková změna nebo doplnění smlouvy o PDD neplatné. Za písemnou formu se považuje pouze forma listinná. Písemná forma není zachována při právním jednání učiněném elektronickými nebo technickými prostředky ve smyslu ustanovení § 562 občanského zákoníku.
4. Za den doručení listinné písemnosti prostřednictvím poštovních služeb učiněné na základě smlouvy o PDD a/nebo těchto JSP se s vyloučením ustanovení § 573 občanského zákoníku považuje den skutečného doručení uvedené písemnosti.
5. V případě omezení licence nebo osvědčení dopravce si Správa železnic vyhrazuje právo okamžitě omezit plnění předmětu smlouvy o PDD a těchto JSP ve shodě s omezením těchto dokumentů.
6. V případě prokázaného opakovaného porušení smluvních podmínek si Správa železnic vyhrazuje právo po předchozím písemném upozornění okamžitě přerušit plnění předmětu smlouvy o PDD a těchto JSP. Obnovení plnění předmětu smlouvy o PDD a těchto JSP je možné po odstranění důvodu či příčiny přerušování plnění.
7. Všechny ve smlouvě o PDD a/nebo v těchto JSP citované právní normy, předpisy Správy železnic, prohlášení o dráze, úřední povolení k provozování dráhy, osvědčení provozovatele dráhy, licence k provozování drážní dopravy a osvědčení dopravce se rozumějí v platném znění. Správa železnic a dopravce se bezodkladně vzájemně informují o všech změnách úředních povolení, licencí nebo osvědčení, o kterých v preambuli smlouvy o PDD prohlašují, že jsou platná a účinná. Dále si Správa železnic a dopravce na požádání druhé strany toto platné a účinné úřední povolení, licenci a/nebo osvědčení vzájemně předloží.
8. Správa železnic a dopravce si vzájemně předloží písemný přehled vyhledaných rizik možného ohrožení života a zdraví svých zaměstnanců, která vyplynou z pracovních činností zaměstnanců obou smluvních stran (viz § 101 odst. 3 zákona č. 262/2006 Sb., zákoníku práce). Správa železnic je pověřena koordinováním provádění opatření k bezpečnosti a ochraně zdraví zaměstnanců a postupů k jejich zajištění.
9. V souladu s § 22 odst. 2 písm. f) a § 35 odst. 2 písm. f) zákona o dráhách Správa železnic a dopravce dodržují zavedené systémy zajišťování bezpečnosti drážní dopravy, svými činnostmi nesmí ohrožovat bezpečné provozování dráhy nebo drážní dopravy a při zjištění rizik vyplývajících z provozování dráhy nebo drážní dopravy přijmou taková opatření, která povedou k jejich eliminaci a prevenci, to vše ve vzájemné součinnosti.
10. Správa železnic a dopravce nejsou oprávněni dát do zástavy či postoupit pohledávky vůči druhé straně smlouvy o PDD, vzniklé ze smlouvy o PDD a/nebo z těchto JSP, bez jejího předchozího písemného souhlasu.
11. Dopravce umožní pověřeným zaměstnancům Správy železnic jízdu na stanovišti strojvedoucího hnacího vozidla (příp. řídicího vozu) dopravce za účelem kontroly železniční dopravní cesty a za účelem nutného umožnění plnění povinností provozovatele dráhy. Nedohodne-li se dopravce se Správou železnic jinak, oprávnění k takové jízdě udělí dopravce jednotlivě v závislosti na konkrétním případě.
12. Bude-li dopravce vykonávat činnosti podle smlouvy o PDD a/nebo těchto JSP jinými osobami než svými zaměstnanci, mají tyto osoby stejná práva a povinnosti podle smlouvy o PDD a těchto JSP jako zaměstnanci dopravce.

Článek 19

Závěrečná ustanovení

1. Právní vztahy neupravené smlouvou o PDD a/nebo těmito JSP se řídí platnými obecně závaznými právními předpisy České republiky a prohlášením o dráze, pokud s nimi nejsou v rozporu.
2. Správa železnic a dopravce jsou povinni dodržovat prohlášení o dráze. Vznikne-li rozpor některého ustanovení smlouvy o PDD a/nebo těchto JSP s ustanovením prohlášení o dráze, platí příslušné ustanovení prohlášení o dráze, leda by bylo v rozporu s obecně závazným právním předpisem.
3. K řešení sporů vyplývajících z realizace smlouvy o PDD a/nebo těchto JSP jsou příslušné soudy České republiky. Tím není dotčena rozhodovací pravomoc ÚPDI stanovená zákonem o dráhách.
4. Smlouva o PDD podléhá povinnosti uveřejnění v registru smluv podle zákona č. 340/2015 Sb. o zvláštních podmínkách účinnosti některých smluv, uveřejňování těchto smluv a o registru smluv (dále jen „zákon o registru smluv“). Smlouvu v registru smluv v souladu s ustanovením zákona o registru smluv uveřejňuje Správa železnic.
5. Při uzavírání smlouvy o PDD Správa železnic a dopravce jednájí a postupují čestně a transparentně. Stejně tak jednájí i při plnění smlouvy o PDD a/nebo těchto JSP a při veškerých činnostech s nimi souvisejících. Správa železnic i dopravce jednájí v souladu se zásadami, hodnotami a cíli compliance programů a etických hodnot druhé smluvní strany, pakliže těmito dokumenty dotčená smluvní strana disponuje, a jsou uveřejněny na webových stránkách této smluvní strany (společnosti).

Annex "R"

Procedures for capacity allocation on Rail Freight Corridor

Harmonized text for timetable 2024

1 Introduction

This annex describes the procedures for capacity allocation by the Corridor One Stop Shop (C-OSS) of a Rail Freight Corridor (Corridor).

All rules concerning applicants, the use of the C-OSS and its products — Pre-arranged Paths (PaPs) and Reserve Capacity (RC) — and how to order them are explained here. The processes, provisions and steps related to PaPs and RC refer to Regulation (EU) No. 913/2010 (Regulation) and are valid for all applicants. For all other issues, the relevant conditions presented in other parts of the Network Statement of the Infrastructure Manager (IMs)/Allocation Body(ABs) concerned are applicable.

This annex is revised and updated for each timetable year. Changes in the legal basis of this annex (e.g. changes in EU regulations, Framework for Capacity Allocation or national regulations) will be implemented with each revision.

Any changes during the running allocation process will be communicated directly to the applicants through publication on the website of the concerned Corridor.

2 Corridor OSS

According to Article 13 of the Regulation, the Management Board (MB) of the Corridor has established a C-OSS. The tasks of the C-OSS are carried out in a non-discriminatory way and it maintains confidentiality regarding applicants.

2.1 Function

The C-OSS is the only body where applicants may request and receive dedicated infrastructure capacity for international freight trains on the Corridor. The handling of the requests takes place in a single place and a single operation. The C-OSS is exclusively responsible for performing all the activities related to the publication and allocation decision with regard to requests for PaPs and RC on behalf of the IMs / ABs concerned.

2.2 Contact

For the contact details to the relevant C-OSS refer to the main body of this Network Statement.

2.3 Language of the C-OSS

The official language of the C-OSS for correspondence is English.

2.4 Tasks of the C-OSS

The C-OSS executes the tasks below during the following processes:

- Collection of international capacity wishes:
 - Consult all interested applicants in order to collect international capacity wishes and needs for the annual timetable by having them fill in a survey. This survey is sent by the C-OSS to the applicants and/or published on the Corridor's website. The results of the survey will be one part of the inputs for the predesign of the PaP offer. It is important to stress that under no circumstances the

Corridor can guarantee the fulfilment of all expressed capacity wishes, nor will there be any priority in allocation linked to the provision of similar capacity.

- Predesign of PaP offer:
 - Give advice on the capacity offer, based on input received from the applicants, and the experience of the C-OSS and IMs/ABs, based on previous years and the results of the Transport Market Study
- Construction phase:
 - Monitor the PaP/RC construction to ensure harmonised border crossing times, calendar days and train parameters
- Publication phase:
 - Publish the PaP catalogue at X-11 in the Path Coordination System (PCS)
 - Inspect the PaP catalogue in cooperation with IMs/ABs, perform all needed corrections of errors detected by any of the involved parties until X-10.5
 - Publish offer for the late path request phase (where late path offer is applicable) in PCS
 - Publish the RC at X-2 in PCS
- Allocation phase: annual timetable (annual timetable process)
 - Collect, check and review all requests for PaPs including error fixing when possible
 - Create a register of the applications and keep it up-to-date (see 2.4.1)
 - Manage the resolution of conflicting requests through consultation where applicable
 - In case of conflicting requests, take a decision on the basis of priority rules adopted by the Executive Board along the Corridor (see 3.1 Framework for Capacity Allocation (FCA))
 - Propose alternative PaPs, if available, to the applicants whose applications have a lower priority value (K value) due to a conflict between several path requests
 - Transmit path requests that cannot be treated to the IM/AB concerned, in order for them to elaborate tailor-made offers
 - Pre-book capacity and inform applicants about the results at X-7.5
 - Allocate capacity (PaPs) in conformity with the relevant international timetabling deadlines (see 3.12) and processes as defined by RailNetEurope (RNE) and according to the allocation rules described in the FCA
 - Monitor the construction of feeder and/or outflow paths by sending these requests to the IMs/ABs concerned and obtain their responses/offers. In case of non-consistent offers (e.g. non-harmonised border times), ask for correction
 - Send the responses/offers (draft offer and final offer including feeder and outflow) to the applicants on behalf of the IMs/ABs concerned
 - Keep the PaP catalogue updated
- Allocation phase: late path requests (annual timetable process)
 - Collect, check and review all requests for the late path request phase including error fixing when possible
 - Allocate capacity for the late path request phase where applicable
 - Monitor the construction of feeder and/or outflow paths by sending these requests to the IMs/ABs concerned and obtain their responses/offers. In case of non-consistent offers (e.g. non-harmonised border times), ask for correction
 - Send the responses/offers to the applicants on behalf of the IMs/ABs concerned
 - Keep the catalogue concerned updated
- Allocation phase: ad-hoc requests (RC) (running timetable process)
 - Collect, check and review all requests for RC including error fixing when possible
 - Create a register of the applications and keep it up-to-date
 - Allocate capacity for RC
 - Monitor the construction of feeder and/or outflow paths by sending these requests to the IMs/ABs concerned and obtain their responses/offers. In case of non-consistent offers (e.g. non-harmonised border times), ask for correction
 - Send the responses/offers to the applicants on behalf of the IMs/ABs concerned
 - Keep the RC catalogue updated

2.4.1 Path register

The C-OSS manages and keeps a path register up-to-date for all incoming requests, containing the dates of the requests, the names of the applicants, details of the documentation supplied and of incidents that have occurred. A path register shall be made freely available to all applicants concerned without disclosing the identity of other applicants, unless the applicants concerned have agreed to such a disclosure. The contents of the register will only be communicated to them on request.

2.5 Tool

PCS is the single tool for publishing the binding PaP and RC offer of the Corridor and for placing and managing international path requests on the Corridor.

Applications for PaPs/RC can only be made via PCS to the involved C-OSS. If the application is made directly to the IMs/ABs concerned, they inform the applicant that they have to place a correct PaP/RC request in PCS via the C-OSS according to the applicable deadlines. PaP/RC capacity requested only through national tools will not be allocated.

In other words, PaP/RC applications cannot be placed through any other tool than PCS.

3 Capacity allocation

The decision on the allocation of PaPs and RC on the Corridor is taken by the C-OSS on behalf of the IMs/ABs concerned. As regards feeder and/or outflow paths, the allocation decision is made by the relevant IMs/ABs and communicated to the applicant by the C-OSS. Consistent path construction containing the feeder and/or outflow sections and the corridor-related path section has to be ensured.

All necessary contractual relations regarding network access have to be dealt with bilaterally between the applicant and each individual IM/AB.

3.1 Framework for Capacity Allocation

Referring to Article 14.1 of the Regulation, the Executive Boards of the Rail Freight Corridors agreed upon a common Framework for Capacity Allocation (FCA). These documents are available in the CIP under <https://cip-online.rne.eu/>. The FCA constitutes the basis for capacity allocation by the C-OSS.

3.2 Applicants

Applicants shall accept the general terms and conditions of the Corridor in PCS before placing their requests.

Without accepting the general terms and conditions, the applicant will not be able to send the request. In case a request is placed by several applicants, every applicant requesting PaP sections has to accept the general terms and conditions for each corridor on which the applicant is requesting a PaP section. In case one of the applicants only requests a feeder or outflow section, the acceptance of the general terms and conditions is not needed.

The acceptance shall be done only once per applicant and per corridor and is valid for one timetable period.

With the acceptance the applicant declares that it:

- has read, understood and accepted the Corridor's CID and, in particular, the Section 4 of it,
- complies with all conditions set by applicable legislation and by the IMs/ABs involved in the paths it has requested, including all administrative and financial requirements,
- shall provide all data required for the path requests,

- accepts the provisions of the national Network Statements applicable to the path(s) requested.

In case of a non-RU applicant, it shall appoint the RU that will be responsible for train operation and inform the C-OSS and IMs/ABs about this RU as early as possible, but at the latest 30 days before the running day. If the appointment is not provided by this date, the PaP/RC is considered as cancelled, and national rules for path cancellation are applicable.

In case the applicant is a non-RU applicant, and applies for feeder / outflow paths, the national rules for nomination of the executing RU will be applied.

3.3 Requirements for requesting capacity

The Corridor applies the international timetabling deadlines defined by RNE for placing path requests as well as for allocating paths (for the Corridor calendar, see <http://www.rne.eu/sales-timetabling/timetabling-calender/> or Chapter 3.12).

All applications have to be submitted via PCS, which is the single tool for requesting and managing capacity on all corridors. The C-OSS is not entitled to create PCS dossiers on behalf of the applicant. If requested, the C-OSS can support applicants in creating the dossiers in order to prevent inconsistencies and guide the applicants' expectations (maximum 1 week prior to the request deadline). The IMs/ABs may support applicants by providing a technical check of the requests.

A request for international freight capacity via the C-OSS has to fulfil the following requirements:

- it must be submitted to a C-OSS by using PCS, including at least one PaP/RC section. Details are explained in the PCS User Manual <http://cms.rne.eu/pcs/pcs-documentation/pcs-basics>,
- it must cross at least one border on a corridor,
- it must comprise a train run from origin to destination, including PaP/RC sections on one or more corridors as well as, where applicable, feeder and/or outflow paths, on all of its running days. In certain cases, which are due to technical limitations of PCS, a request may have to be submitted in the form of more than one dossier. These specific cases are the following:
 - Different origin and/or destination depending on running day (But using identical PaP/RC capacity for at least one of the IMs for which capacity was requested).
 - Transshipment from one train onto different trains (or vice versa) because of infrastructure restrictions.
 - The IM/AB specifically asks the applicant to split the request into two or more dossiers.

To be able for the C-OSS to identify such dossiers as one request, and to allow a correct calculation of the priority value (K value) in case a request has to be submitted in more than one dossier, the applicant should indicate the link among these dossiers in PCS. Furthermore, the applicant should mention the reason for using more than one dossier in the comment field.

- the technical parameters of the path request have to be within the range of the parameters – as originally published – of the requested PaP sections (exceptions are possible if allowed by the IM/AB concerned, e.g. when the timetable of the PaP can be respected)
- as regards sections with flexible times, the applicant may adjust/insert times, stops and parameters according to its individual needs within the given range.

In case of some Corridors further specific requirements for additional cases may be applied. For the description of such requirements refer to the CIDs of individual Corridors.

3.4 Annual timetable phase

3.4.1 PaPs

PaPs are a joint offer of coordinated cross-border paths for the annual timetable produced by IMs/ABs involved in the Corridor. The C-OSS acts as a single point of contact for the publication and allocation of PaPs.

PaPs constitute an off-the-shelf capacity product for international rail freight services. In order to meet the applicants' need for flexibility and the market demand on the Corridor, PaPs are split up in several sections, instead of being supplied as entire PaPs, as for example from 'Start Point(s)' to 'End Point(s)'. Therefore, the offer might also include some purely national PaP sections – to be requested from the C-OSS for freight trains crossing at least one border on a corridor in the context of international path applications.

A catalogue of PaPs is published by the C-OSS in preparation of each timetable period. It is published in PCS.

PaPs are published in PCS at X-11. Between X-11 and X-10.5 the C-OSS is allowed to perform, in PCS, all needed corrections of errors regarding the published PaPs detected by any of the involved parties. In this phase, the published PaPs have 'read only' status for applicants, who may also provide input to the C-OSS regarding the correction of errors.

3.4.2 Schematic corridor map

A schematic map of each Corridor can be found as an annex to its CID.

3.4.3 Features of PaPs

A PaP timetable is published containing one of the following features:

- Sections with fixed times (data cannot be modified in the path request by an applicant).
 - Capacity with fixed origin, intermediate and destination times within one IM/AB.
 - Intermediate Points and Operational Points with fixed times. Requests for changes to the published PaP have to be examined by the IMs/ABs concerned and can only be accepted if they are feasible and if this does not change the calculation of the priority rule in case of conflicting requests at X-8.
- Sections with flexible times (data may be modified in the path request by an applicant according to individual needs, but without exceeding the given range of standard running times, stopping times and train parameters. Where applicable, the maximum number of stops and total stopping time per section have to be respected).
 - Applicants are free to include their own requirements in their PaP request within the parameters mentioned in the PaP catalogue.
 - Where applicable, the indication of standard journey times for each corridor section has to be respected.
 - Optional: Intermediate Points without fixed times. Other points on the Corridor may be requested.
 - Optional: Operational Points without fixed times.

Requests for changes outside of the above-mentioned flexibility have to be examined by the IMs/ABs concerned if they accept the requests. The changes can only be accepted if they are feasible.

The C-OSS promotes the PaPs by presenting them to existing and potential applicants.

For the description of further specificities refer to the CIDs of individual Corridors.

In case of some Corridors the capacity bandwidth approach may be applied. For the description of the characteristics of specific capacity bandwidth approaches refer to the CIDs of individual Corridors.

3.4.4 Multiple corridor paths

It is possible for capacity requests to cover more than one corridor. A PaP offer harmonised by different corridors may be published and indicated as such. The applicant may request PaP sections on different corridors within one request. Each C-OSS remains responsible for allocating its own PaP sections, but the applicant may address its questions to only one of the involved C-OSSs, who will coordinate with the other concerned C-OSSs whenever needed.

Multiple corridor paths on the Corridor are to be displayed on a map in Annex 4C to the CID of each Corridor.

3.4.5 PaPs on overlapping sections

The layout of the corridor lines leads to situations where some corridor lines overlap with others. The aim of the corridors, in this case, is to prepare the best possible offer, taking into account the different traffic flows and to show the possible solutions to link the overlapping sections concerned with the rest of the corridors in question.

In case of overlapping sections, corridors may develop a common offer, visible via all corridors concerned. These involved corridors will decide which C-OSS is responsible for the final allocation decision on the published capacity. In case of conflict, the responsible C-OSS will deal with the process of deciding which request should have priority together with the other C-OSSs. In any case, the applicant will be consulted by the responsible C-OSS.

Description of common offers on overlapping sections is to be displayed on a map in Annex 4C to the CID of each Corridor.

3.4.6 Feeder, outflow and tailor-made paths

In case available PaPs do not cover the entire requested path, the applicant may include a feeder and/or outflow path to the PaP section(s) in the international request addressed to the C-OSS via PCS in a single request.

A feeder/outflow path refers to any path section prior to reaching an Intermediate Point on a corridor (feeder path) or any path section after leaving a corridor at an Intermediate Point (outflow path).

Feeder / outflow paths will be constructed on request in the PCS dossiers concerned by following the national path allocation rules. The offer is communicated to the applicant by the C-OSS within the same time frame available for the communication of the requested PaPs. Requesting a tailor-made path between two PaP sections is possible, but because of the difficulty for IMs/ABs to link two PaP sections, a suitable offer might be less likely (for further explanation see 3.4.16).

Graph with possible scenarios for feeder/outflow paths in connection with a request for one or more PaP section(s):

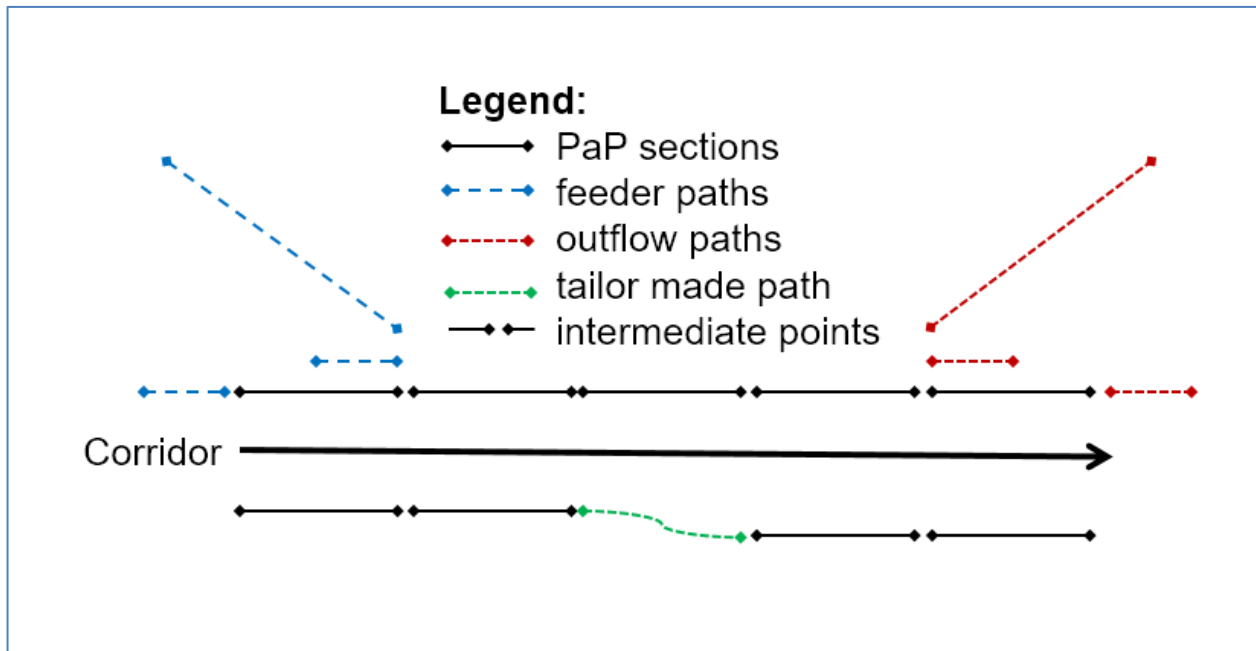

3.4.7 Handling of requests

The C-OSS publishes the PaP catalogue at X-11 in PCS, inspects it in cooperation with IMs/ABs, and performs all needed corrections of errors detected by any of the involved parties until X-10.5. Applicants can submit their requests until X-8. The C-OSS offers a single point of contact to applicants, allowing them to submit requests and receive answers regarding corridor capacity for international freight trains crossing at least one border on a corridor in one single operation. If requested, the C-OSS can support applicants in creating the dossiers in order to prevent inconsistencies and guide the applicants' expectations. The IMs/ABs may support the applicants by providing a technical check of the requests.

3.4.8 Leading tool for the handling of capacity requests

Applicants sending requests to the C-OSS shall use PCS. Within the construction process of feeder and/or outflow paths and tailor-made paths, the national tool may show additional information to the applicant.

The following matrix shows for each step of the process which tool is considered as the leading tool.

Phase	Application (till X-8)	Withdrawal (X-8)	Pre-booking (X-7.5)	Draft offer (X-5)	Observation (X-5 till X-4)	Final offer (X-3.5)	Acceptance (until X-3)	Modification (after X-4)	Cancellation (after X-4)
Leading tool	PCS	PCS	PCS	PCS	PCS	PCS	PCS	National tool/PCS*	National tool/PCS*
Additional tool			Email (for pre-booking information)						

* To be checked by each IM, whether requests for modification or cancellation via PCS are accepted.

If applicable, the following sentence shall be added: Modifications/Cancellations after X-4 have to be placed in the [IMs name/tool].

3.4.9 Check of the applications

The C-OSS assumes that the applicant has accepted the published PaP characteristics by requesting the selected PaP. However, for all incoming capacity requests it will perform the following plausibility checks:

- Request for freight train using PaP and crossing at least one border on a corridor
- Request without major change of parameters

If there are plausibility flaws, the C-OSS may check with the applicant whether these can be resolved:

- if the issue can be solved, the request will be corrected by the C-OSS (after the approval of the applicants concerned) and processed like all other requests. The applicant has to accept or reject the corrections within 5 calendar days. In case the applicant does not answer or reject the corrections, the C-OSS forwards the original request to the IM/AB concerned.
- if the issue cannot be resolved, the request will be rejected.

All requests not respecting the published offer are immediately forwarded by the C-OSS to the IM/AB concerned for further treatment. In those cases, answers are provided by the involved IM/AB. The IMs/ABs will accept them as placed in time (i.e. until X-8).

In case of some Corridors additional checks may be applied. For the description of these additional checks refer to the CIDs of individual Corridors.

In case of missing or inconsistent data the C-OSS directly contacts the leading applicant and asks for the relevant data update/changes to be delivered within 5 calendar days.

In general: in case a request contains PaPs on several corridors, the C-OSSs concerned check the capacity request in cooperation with the other involved C-OSS(s) to ensure their cooperation in treating multiple corridor requests. This way, the cumulated length of PaPs requested on each corridor is used to calculate the priority value (K value) of possible conflicting requests (see more details in 3.4.11). The different corridors can thus be seen as part of one combined network.

3.4.10 Pre-booking phase

In the event of conflicting requests for PaPs placed until X-8, a priority rule is applied. The priority rules are stated in the FCA (see 3.1) and in 3.4.11.

On behalf of the IMs/ABs concerned and according to the result of the application of the priority rules - as detailed in 3.4.11 - the C-OSS pre-books the PaPs.

The C-OSS also forwards the requested feeder/outflow path and/or adjustment to the IMs/ABs concerned for elaboration of a timetable offer fitting to the PaP already reserved (pre-booked), just as might be the case with requests with a lower priority value (priority rule process below). The latter will be handled in the following order:

- consultation may be applied
- alternatives may be offered (if available)
- if none of the above steps were applied or successful, the requested timetable will be forwarded to the IMs/ABs concerned to elaborate a tailor-made offer as close as possible to the initial request.

3.4.11 Priority rules in capacity allocation

Conflicts are solved with the following steps, which are in line with the FCA:

- A) A resolution through consultation may be promoted and performed between applicants and the C-OSS, if the following criteria are met:
 - The conflict is only on a single corridor.
 - Suitable alternative PaPs are available.

B) Applying the priority rule as described in Annex 1 of the FCA (see 3.1) and in 3.4.13 and 3.4.14.

- a. Cases where no Network PaP is involved (see 3.4.13)
- b. Cases where Network PaP is involved in at least one of the requests (see 3.4.14)

The Table of Distances in Annex 4.E to the CID of each Corridor shows the distances taken into account in the priority calculation.

C) Random selection (see 3.4.15).

In the case that more than one PaP is available for the published reference PaP, the C-OSS pre-books the PaPs with the highest priority until the published threshold is reached. When this threshold is reached, the C-OSS will apply the procedure for handling requests with a lower priority as listed above.

In case of some Corridors the resolution through consultation may be applied. For the description of such resolution through consultation refer to the CIDs of individual Corridors.

3.4.12 Network PaP

A Network PaP is not a path product. However, certain PaPs may be designated by Corridors as 'Network PaPs', in most cases for capacity requests involving more than one Corridor. Network PaPs are designed to be taken into account for the definition of the priority of a request, for example on PaP sections with scarce capacity. The aim is to make the best use of available capacity and provide a better match with traffic demand.

For the time being, Network PaPs are not being offered by any of the Corridors.

3.4.13 Priority rule in case no Network PaP is involved

The priority is calculated according to this formula:

$$K = (L^{PAP} + L^{F/O}) \times Y^{RD}$$

L^{PAP} = Total requested length of all PaP sections on all involved RFCs included in one request.

The definition of a request can be found in 3.3.

$L^{F/O}$ = Total requested length of the feeder/outflow path(s) included in one request; for the sake of practicality, is assumed to be the distance as the crow flies.

Y^{RD} = Number of requested running days for the timetable period. A running day will only be taken into account for the priority calculation if it refers to a date with a published PaP offer for the given section.

K = The rate for priority

All lengths are counted in kilometres.

The method of applying this formula is:

- *in a first step the priority value (K) is calculated using only the total requested length of pre-arranged path (L^{PAP}) multiplied by the Number of requested running days (Y^{RD});*
- *if the requests cannot be separated in this way, the priority value (K) is calculated using the total length of the complete paths ($L^{PAP} + L^{F/O}$) multiplied by the number of requested running days (Y^{RD}) in order to separate the requests;*
- *if the requests cannot be separated in this way, a random selection is used to separate the requests. This random selection is described in 3.4.15.*

3.4.14 Priority rule if a Network PaP is involved in at least one of the conflicting requests

For the time being, Network PaPs are not being offered by any of the Corridors.

3.4.15 Random selection

If the requests cannot be separated by the above-mentioned priority rules, a random selection is used to separate the requests.

- The respective applicants will be acknowledged of the undecided conflict before X-7.5 and invited to attend a drawing of lots.
- The actual drawing will be prepared and executed by the C-OSS, with complete transparency.
- The result of the drawing will be communicated to all involved parties, present or not, via PCS and e-mail, before X-7.5.

In case of some Corridors a different rule for the random selection process may be applied. For the description of such different rule for the random selection process refer to the CIDs of individual Corridors.

3.4.16 Special cases of requests and their treatment

The following special use of PaPs is known out of the allocation within the past timetables: Division of continuous offer in shares identified by the PaP ID (PaPs / non-PaPs). This refers to the situation when applicants request corridor capacity (on one or more corridors) in the following order:

- 1) PaP section
- 2) Tailor-made section
- 3) PaP section

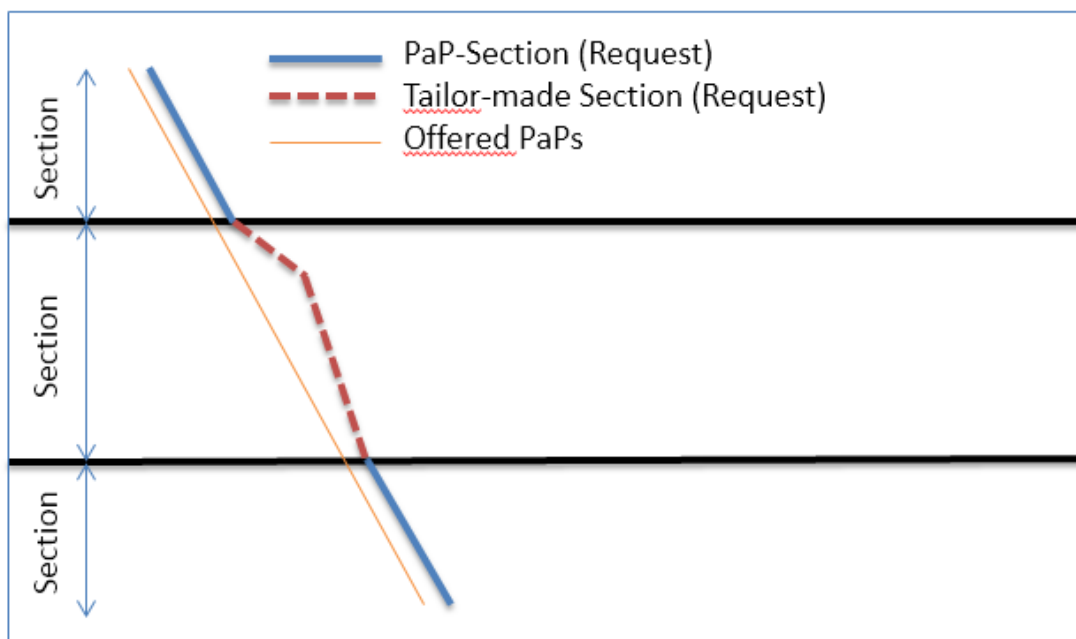

These requests will be taken into consideration, depending on the construction starting point in the request, as follows:

- Construction starting point at the beginning: The C-OSS pre-books the PaP sections from origin until the end of the first continuous PaP section. No section after the interruption of PaP sections will be pre-booked; they will be treated as tailor-made.
- Construction starting point at the end: The C-OSS pre-books the PaP sections from the destination of the request until the beginning of the last continuous PaP section. No sections between the origin and the interruption of the PaP sections will be pre-booked; they will be treated as tailor-made.
- Construction starting point in the middle: The C-OSS pre-books the longest of the requested PaP sections either before or after the interruption. No other sections will be pre-booked; they will be treated as tailor-made.

However, in each of the above cases, the requested PaP capacity that becomes tailor-made might be allocated at a later stage if the IMs/ABs can deliver the tailor-made share as requested. In case of allocation, the PaP share that can become tailor-made retains full protection. This type of request doesn't influence the application of the priority rule.

3.4.17 Result of the pre-booking

The C-OSS provides interim information to applicants regarding the status of their application no later than X-7.5.

In the case that consultation was applied, the applicants concerned are informed about the outcome.

In the case that no consultation was applied, the interim notification informs applicants with a higher priority value (K value) about pre-booking decisions in their favour.

In case of conflicting requests with a lower priority value, the C-OSS shall offer an alternative PaP, if available. The applicant concerned has to accept or reject the offered alternative within 5 calendar days. In case the applicant does not answer, or rejects the alternative, or no alternative is available, the C-OSS forwards the original request to the IM/AB concerned. The C-OSS informs the applicants with a lower priority value (K value) by X-7.5 that their path request has been forwarded to the IM/AB concerned for further treatment within the regular process for the annual timetable construction, and that the C-OSS will provide the draft path offer on behalf of the IM/AB concerned at X-5 via PCS. These applications are handled by the IM/AB concerned as on-time applications for the annual timetable and are therefore included in the regular national construction process of the annual timetable.

3.4.18 Handling of non-requested PaPs

There are two ways of handling non-requested PaPs at X-7.5, based on the decision of the MB.

- A) After pre-booking, all non-requested PaPs are handed over to the IM/AB.
- B) The MB takes a decision regarding the capacity to be republished after X-7.5. This decision depends on the "booking situation" at that moment. More precisely, at least the following three criteria must be fulfilled in the following order of importance):
 1. There must be enough capacity for late requests, if applicable, and RC.
 2. Take into account the demand for international paths for freight trains placed by other means than PCS.
 3. Take into account the need for modification of the capacity offer due to possible changes in the planning of TCRs.

Information on the way in which the non-requested PaPs are being handled is provided in the CID of each Corridor.3.4.19 Draft offer

After receiving the pre-booking decision by the C-OSS, the IMs/ABs concerned will elaborate the flexible parts of the requests:

- Feeder, outflow or intermediate sections
- Pre-booked sections for which the published timetable is not available anymore due to external influences, e.g. temporary capacity restrictions
- In case of modifications to the published timetable requested by the applicant
- In case of an alternative offer that was rejected by the applicant or is not available

In case IMs/ABs cannot create the draft offer due to specific wishes of the applicant not being feasible, the C-OSS has to reject the request.

The C-OSSs shall be informed about the progress, especially regarding the parts of the requests that cannot be fulfilled, as well as conflicts and problems in harmonising the path offers.

At the RNE draft timetable deadline (X-5) the C-OSS communicates the draft timetable offer for every handled request concerning pre-booked PaPs including feeder and/or outflow, tailor-made

sections and tailor-made offers in case of conflicting requests to the applicant via PCS on behalf of the IM/AB concerned.

Corridor Specificities

The IMs/ABs can mark areas in which the flexibility will be available even after the final offer (in case the IMs/ABs create the actual timetable only shortly before operations) as 'Flexible after allocation'.

[To be checked by each IM/AB, whether this applies.]

3.4.20 Observations

Applicants can place observations on the draft timetable offer in PCS one month from the date stated in 3.12, which are monitored by the C-OSS. The C-OSS can support the applicants regarding their observations. This procedure only concerns observations related to the original path request — whereas modifications to the original path requests are treated as described in 3.7.1 (without further involvement of the C-OSS).

3.4.21 Post-processing

Based on the above-mentioned observations the IMs/ABs have the opportunity to revise offers between X-4 and X-3.5. The updated offer is provided to the C-OSS, which – after a consistency check – submits the final offer to the applicant in PCS.

3.4.22 Final offer

At the final offer deadline (X-3.5), the C-OSS communicates the final timetable offer for every valid PaP request including feeder and/or outflow, tailor-made sections and tailor-made offers in case of conflicting requests to the applicants via PCS on behalf of the IM/AB concerned. If, for operational reasons, publication via national tools is still necessary (e.g. to produce documents for train drivers), the IMs/ABs have to ensure that there are no discrepancies between PCS and the national tool.

Corridor Specificities

The IMs/ABs can mark areas in which flexibility will be available even after the final offer (in case the IMs/ABs create the actual timetable only shortly before operations) as 'Flexible after allocation'.

[To be checked by each IM/AB, whether this applies.]

The applicants involved shall accept or reject the final offer within 5 calendar days in PCS.

- Acceptance > leads to allocation
- Rejection > leads to withdrawal and closing of the request
- No answer > The C-OSS will actively try to get an answer. In case there is no answer from the applicants, the C-OSS will end the process (no allocation).

If not all applicants agree on the final offer, the request will be considered as unanswered.

3.5 Late path request phase

Late path requests refer to capacity requests concerning the annual timetable sent to the C-OSS within the timeframe from X-7.5 until X-2.

It is stated in the CID of each Corridor whether it offers the possibility to place late path requests or not.

3.5.1 Product

Capacity for late path requests can be offered in the following ways:

- A) In the same way, as for PaPs, either specially constructed paths for late path requests or PaPs which were not used for the annual timetable.

- B) On the basis of capacity slots. Slots are displayed per corridor section and the standard running time is indicated. To order capacity for late path requests, corridor sections without any time indications are available in PCS. The applicant may indicate his individually required departure and/or arrival times, and feeder and outflow path(s), as well as construction starting point. The indications should respect the indicated standard running times.

Capacity for late path request has to be requested via PCS either in the same way as for PaPs or by using capacity slots in PCS.

If the Corridor offers the possibility to place late path requests, it is stated in the CID of that Corridor which of the above variants would be used.

3.5.2 Multiple corridor paths

It is possible for capacity requests to cover more than one corridor if capacity is offered. See 3.4.4.

3.5.3 Late paths on overlapping sections

See 3.4.5.

Description of common offers on overlapping sections can be found on a map in Annex 4C to the CID of each Corridor.

3.5.4 Handling of requests

The C-OSS receives and collects all path requests that are placed via PCS.

3.5.5 Leading tool for late path requests

Applicants sending late path requests to the C-OSS shall use PCS. Within the construction process, the national tool may show additional information to the applicant.

The following matrix shows for each step of the process which tool is considered as the leading tool.

Phase	Application (X-7.5 till X-2)	Withdrawal (X-8 till X-2)	Offer (X-1)	Acceptance (until X-0.75)	Modification	Cancellation
Leading tool	PCS	PCS	PCS	PCS	National tool/PCS*	National tool/PCS*

To be checked by each IM, whether requests for modification or cancellation via PCS are accepted.

If applicable, the following sentence shall be added: Modifications/Cancellations have to be placed in the [IMs name/tool].

3.5.6 Check of the applications

The C-OSS checks all requests as described in 3.4.9.

3.5.7 Pre-booking

The C-OSS coordinates the offer with the IMs/ABs concerned or other C-OSS if needed by following the rule of "first come – first served".

3.5.8 Path elaboration

During the path elaboration phase, the IMs/ABs concerned will prepare the Late Path offer under coordination of the C-OSS.

3.5.9 Late request offer

All applicants involved shall accept, ask for adaptations or reject the late request offer within 5 calendar days in PCS. By triggering the 'ask for adaptation' function, applicants can place comments on the late request offer, which will be monitored by the C-OSS. This procedure only concerns comments related to the original path request – whereas modifications to the original path requests are treated as described in 3.7.1 (without further involvement of the C-OSS).

- Acceptance > leads to allocation
- Ask for adaptations > late offer can be returned to path elaboration with comments; IM/AB will make an alternative proposal; however, if no alternatives are possible, the applicant will have to prepare a new request
- Rejection > leads to withdrawal and closing of the request
- No answer > The C-OSS will actively try to get an answer. In case there is still no answer from the applicants, the C-OSS will end the process (no allocation)

If not all applicants agree on the final offer, the request will be considered as unanswered.

3.6 Ad-hoc path request phase

3.6.1 Reserve capacity (RC)

During the ad-hoc path request phase, the C-OSS offers RC based on PaPs or capacity slots to allow for a quick and optimal answer to ad-hoc path requests:

- A. RC based on PaPs will be a collection of several sections along the Corridor, either of non-requested PaPs and/or PaPs constructed out of remaining capacity by the IMs/ABs after the allocation of overall capacity for the annual timetable as well as in the late path request phase.
- B. In case RC is offered on the basis of capacity slots, slots are displayed per corridor section and the standard running time is indicated. The involved IMs/ABs jointly determine the amount of RC for the next timetable year between X-3 and X-2. The determined slots may not be decreased by the IMs/ABs during the last three months before real time.

To order reserve capacity slots, corridor sections without any time indication are available in PCS. The applicant may indicate his individually required departure and/or arrival times, feeder and outflow path(s) as well as construction starting point. The indications should respect the indicated standard running times as far as possible.

It is stated in the CID of each Corridor through which variant that Corridor offers RC. In case a Corridor offers the RC through variant B, the relevant time frames are also specified in the CID of that Corridor.

RC is published by the C-OSS at X-2 in PCS.

The IMs can modify or withdraw RC for a certain period in case of unavailability of capacity due to force majeure. Applicants can book RC via the C-OSS until 30 days before the running day. To make ad-hoc requests less than 30 days before the running day, they have to contact the IMs/ABs directly.

3.6.2 Multiple corridor paths

It is possible for capacity requests to cover more than one corridor. See 3.4.4.

3.6.3 Reserve capacity on overlapping sections

See 3.4.5.

Description of common offers on overlapping sections is to be displayed on a map in Annex 4C to the CID of each Corridor.

3.6.4 Feeder, outflow and tailor-made paths

See 3.4.6. For RC the same concept applies as for PaPs in the annual timetable.

3.6.5 Handling of requests

The C-OSS receives and collects all path requests for RC placed via PCS until 30 days before the running day. If requested, the C-OSS can support applicants in creating the dossiers to prevent inconsistencies and guide the applicants' expectations. The IMs/ABs may support the applicants by providing a technical check of the requests.

3.6.6 Leading tool for ad-hoc requests

Applicants sending requests for RC to the C-OSS shall use PCS. Within the construction process, the national tool may show additional information to the applicant.

The following matrix shows for each step of the process which tool is considered as the leading tool.

Phase	Application and allocation (X-2 till X+12)	Withdrawal	Offer (10 calendar days before train run)	Answer (within 5 calendar days after offer)	Modification	Cancellation
Leading tool	PCS	PCS	PCS	PCS	National tool/PCS*	National tool/PCS*

To be checked by each IM, whether requests for modification or cancellation via PCS are accepted.

If applicable, the following sentence shall be added: Modifications/Cancellations have to be placed in the [IMs name/tool].

3.6.7 Check of the applications

The C-OSS checks all requests as described in 3.4.9.

3.6.8 Pre-booking

The C-OSS applies the 'first come – first served' rule.

3.6.9 Path elaboration

During the path elaboration phase, the IMs/ABs concerned will prepare the offer under coordination of the C-OSS.

3.6.10 Ad-hoc request offer

Applicants shall receive the ad-hoc offer no later than 10 calendar days before the train run. All applicants involved shall accept, ask for adaptations or reject the ad-hoc offer within 5 calendar days in PCS. By triggering the 'ask for adaptation' function, applicants can place comments on the ad-hoc request offer, which will be monitored by the C-OSS. This procedure only concerns comments related to the original path request – whereas modifications to the original path requests are treated as described in 3.7.1 (without further involvement of the C-OSS).

- Acceptance > leads to allocation
- Ask for adaptations > ad-hoc offer can be returned to path elaboration with comments; IM/AB will make an alternative proposal; however, if no alternatives are possible, the applicant will have to prepare a new request
- Rejection > leads to withdrawal of the offer and closing of the request
- No answer > The C-OSS will actively try to get an answer. In case there is still no answer from the applicants, the C-OSS will end the process (no allocation)

If not all applicants agree on the final offer, the request will be considered as unanswered.

3.7 Request for changes by the applicant

3.7.1 Modification

The Sector Handbook for the communication between Railway Undertakings and Infrastructure Managers (RU/IM Telematics Sector Handbook) is the specification of the TAF-TSI (EC) No. 1305/2014 Regulation. According to its Annex 12.2 UML Model of the yearly timetable path request, it is not possible to place change requests for paths (even including PaPs) by the applicant between X-8 and X-5. The only option in this period is the deletion, meaning the withdrawal, of the path request.

3.7.2 Withdrawal

Withdrawing a request is only possible

- After submitting the request (until X-8) until the final offer
- before allocation during the late path request phase (where applicable) and ad-hoc path request phase.

Resubmitting the withdrawn dossier will be considered as annual request only until X-8.

The national rules regarding withdrawal fees and deadlines will apply.

3.7.3 Transfer of capacity

Once capacity is pre-booked or allocated to an applicant, it shall not be transferred by the recipient to another applicant. The use of capacity by an RU that carries out business on behalf of a non-RU applicant is not considered a transfer.

3.7.4 Cancellation

Cancellation refers to the phase between final allocation and the train run. Cancellation can refer to one, several or all running days and to one, several or all sections of the allocated path.

In case a path has to be cancelled, for whatever reason, the cancellation has to be done according to national processes.

3.7.5 Unused paths

If an applicant or designated RU does not use the allocated path, the case is treated according to the national rules.

3.8 Exceptional transport and dangerous goods

3.8.1 Exceptional transport

PaPs and RC do not include the possibility to manage exceptional consignments (e.g. out-of-gauge loads). The parameters of the PaPs and RC offered have to be respected, including the published combined transport profiles.

Requests for exceptional consignments are forwarded by the C-OSS directly to the IMs/ABs concerned for further treatment.

3.8.2 Dangerous goods

Dangerous goods may be loaded on trains using PaPs or RC if both international and national rules concerning the movement of hazardous material are respected (e.g. according to RID – Regulation governing the international transport of dangerous goods by rail).

Dangerous goods have to be declared, when making a path request, to all IMs/ABs on the Corridor.

3.9 Rail related services

Rail related services are specific services, the allocation of which follows national rules and partially other deadlines than those stipulated in the process of path allocation. Therefore, the request has to be sent to the IMs/ABs concerned directly.

If questions regarding rail related services are sent to the C-OSS, he/she contacts the IMs/ABs concerned, who provide an answer within a reasonable time frame.

3.10 Contracting and invoicing

Network access contracts are concluded between IMs/ABs and the applicant on the basis of national network access conditions.

The C-OSS does not issue any invoices for the use of allocated paths. All costs (charges for using a path, administration fees, etc.) are invoiced by the relevant IMs/ABs according to national rules.

3.11 Appeal procedure

Based on Article 20 of the Regulation: in case of complaints regarding the allocation of PaPs (e.g. due to a decision based on the priority rules for allocation), the applicants may address the relevant Regulatory Body (RB) as stated in the Cooperation Agreement signed between RBs on the Corridor.

For a link to the Cooperation Agreements among the RBs refer to the CID of each Corridor.

3.12 Table of deadlines

Date / Deadline	Date in X-System	Description of Activities
9 January 2023	X-11	Publication of PaP Catalogue
10 January 2023 – 23 January 2023	X-11 – X-10.5	Correction phase (corrections of errors to published PaPs)
11 April 2023	X-8	Last day to request a PaP
17 April 2023		Last day to inform applicants about the alternative PaP offer
24 April 2023	X-7.5	Last day for C-OSS to send PaP pre-booking information to applicants
3 July 2023	X-5	Publication of draft timetable
4 July 2023 – 4 August 2023	X-5 – X-4	Observations and comments from applicants
25 April 2023 – 16 October 2023	X-7.5 – X-2	Late path request application phase via the C-OSS

22 August 2023 – 13 November 2023	X-3.5 – X-1	Late path request allocation phase
21 August 2023	X-3.5	Publication of final offer
26 August 2023	X-3	Acceptance of final offer
9 October 2023	X-2	Publication of RC
10 December 2023	X	Timetable change
10 October 2023 – 14 December 2024	X-2 - X+12	Application and allocation phase for RC

M01 Číslování tratí podle Úředního povolení

Numbering of lines according to Official Permit

čísla tratí jsou pěticiferná ve tvaru XXX 00; v mapě jsou uvedeny vždy jen první tři číslice
 numbers of lines have five figures in form XXX 00; only first three figures are presented in map

- 100** číslo trate
number of line
- trať ve vlastnictví jiného subjektu
line owned by another subject

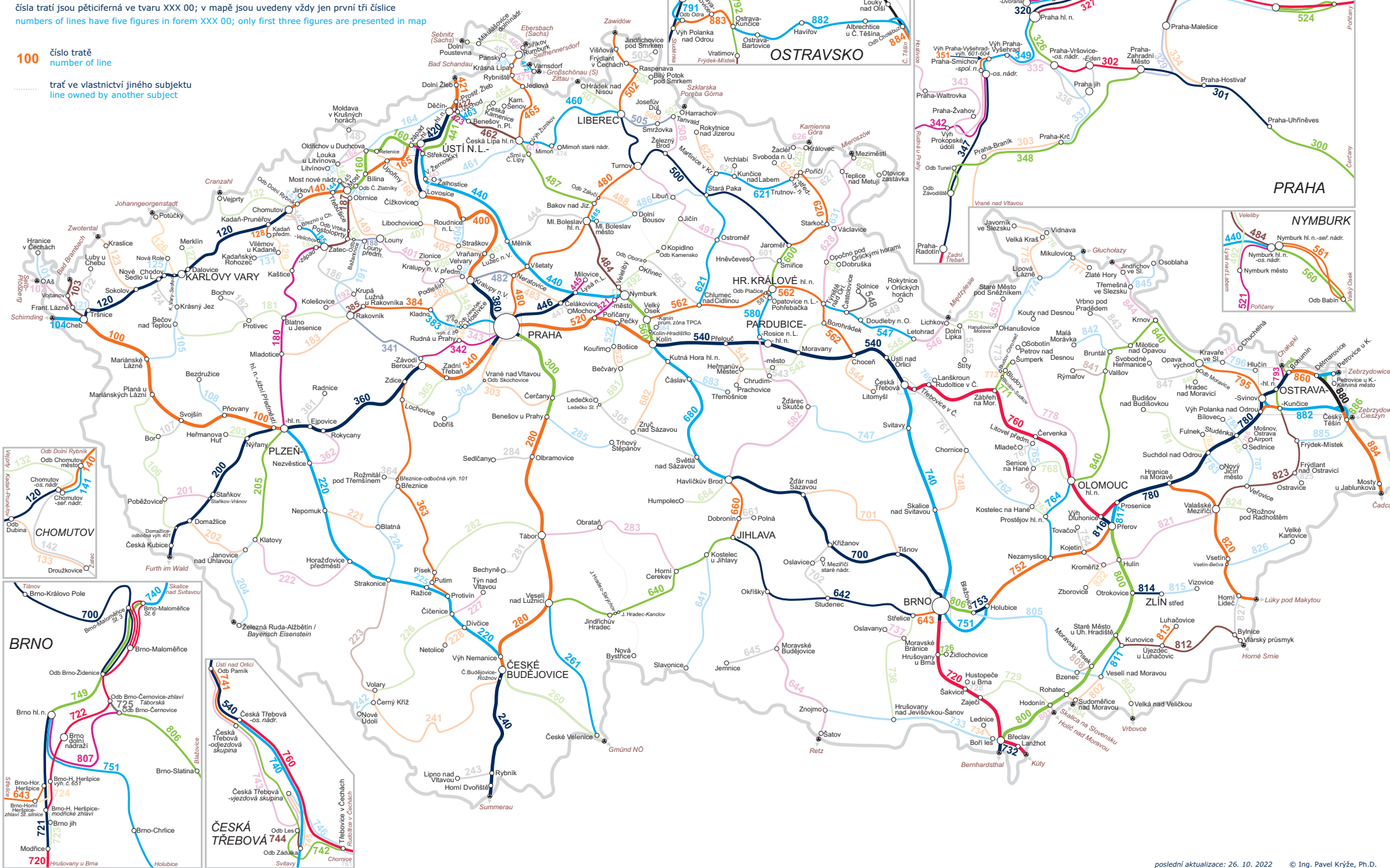
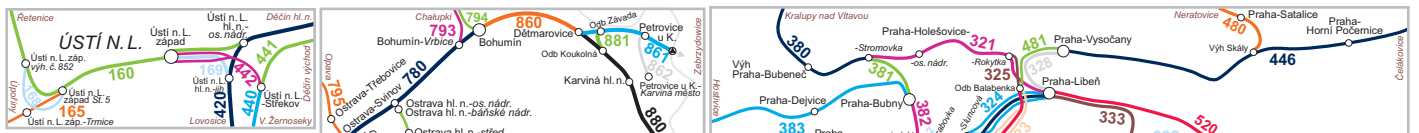

M02 Kategorie drah a provozovatelé drah

Category of railways and rail system operators

dráhy celostátní / nation-wide rail system:

- tratě zařazené do systému TEN-T / the lines of system TEN-T
- ostatní dráhy celostátní / the other lines of nation-wide rail system

provozovatel drah celostátních / operator of nation-wide rail system:

Správa železnic, státní organizace, se sídlem Praha 1, Dlázděná 1003/7, PSC: 110 00 a s identifikačním číslem 70994234
 Správa železnic, státní organizace, having its registered office at Dlázděná 1003/7, Post Code Number: 110 00, Praha 1 and Administrative Identification Number 70994234

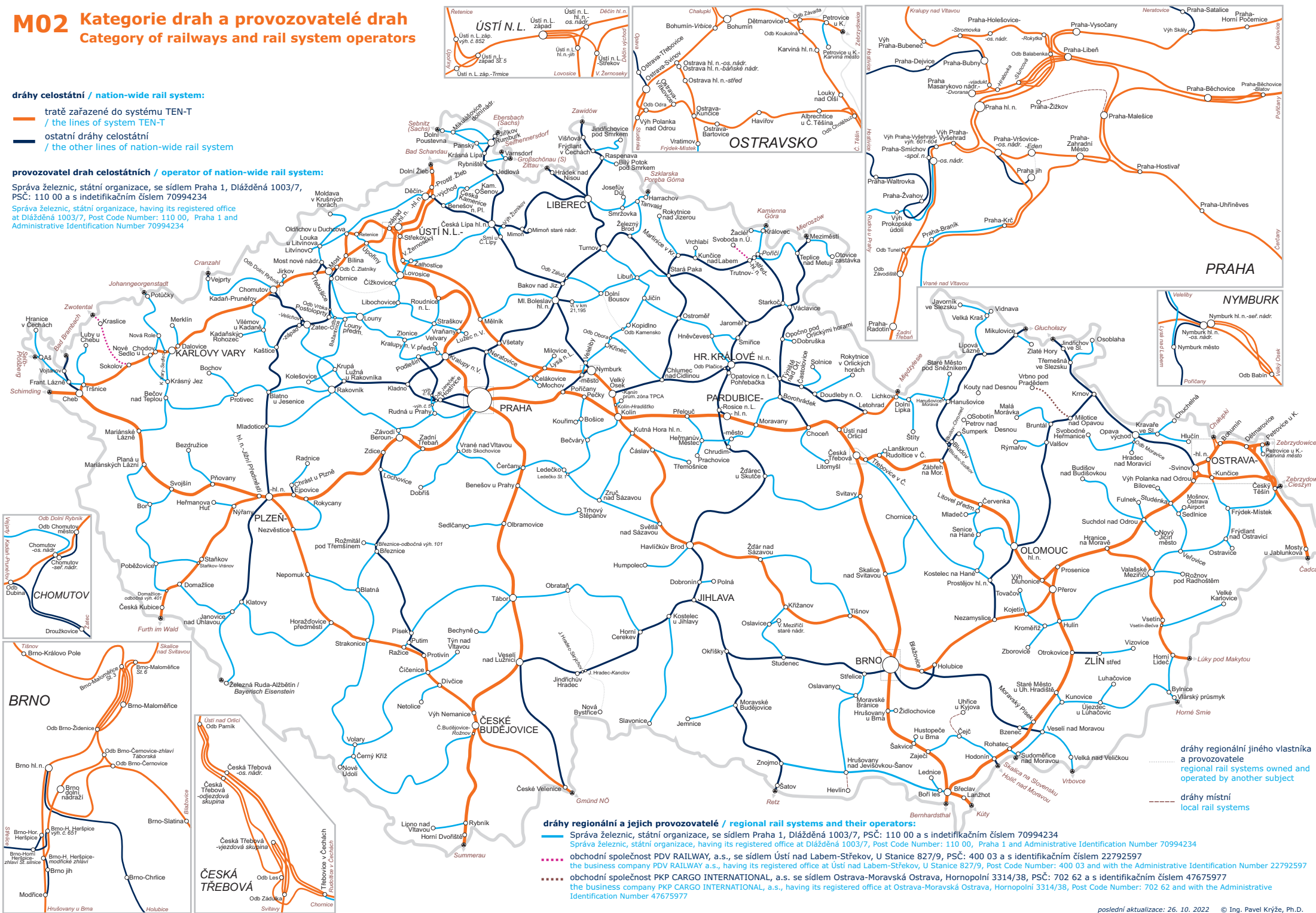

dráhy regionální a jejich provozovatelé / regional rail systems and their operators:

- Správa železnic, státní organizace, se sídlem Praha 1, Dlázděná 1003/7, PSC: 110 00 a s identifikačním číslem 70994234
 Správa železnic, státní organizace, having its registered office at Dlázděná 1003/7, Post Code Number: 110 00, Praha 1 and Administrative Identification Number 70994234
- - - - obchodní společnost PDV RAILWAY, a.s., se sídlem Ústí nad Labem-Střekov, U Stanice 827/9, PSC: 400 03 a s identifikačním číslem 22792597
 the business company PDV RAILWAY a.s., having its registered office at Ústí nad Labem-Střekov, U Stanice 827/9, Post Code Number: 400 03 and with the Administrative Identification Number 22792597
- - - - obchodní společnost PKP CARGO INTERNATIONAL, a.s. se sídlem Ostrava-Moravská Ostrava, Hornopólní 3314/38, PSC: 702 62 a s identifikačním číslem 47675977
 the business company PKP CARGO INTERNATIONAL, a.s., having its registered office at Ostrava-Moravská Ostrava, Hornopólní 3314/38, Post Code Number: 702 62 and with the Administrative Identification Number 47675977

dráhy regionální jiného vlastníka a provozovatele
 regional rail systems owned and operated by another subject

dráhy místní
 local rail systems

M03 Evropské nákladní koridory





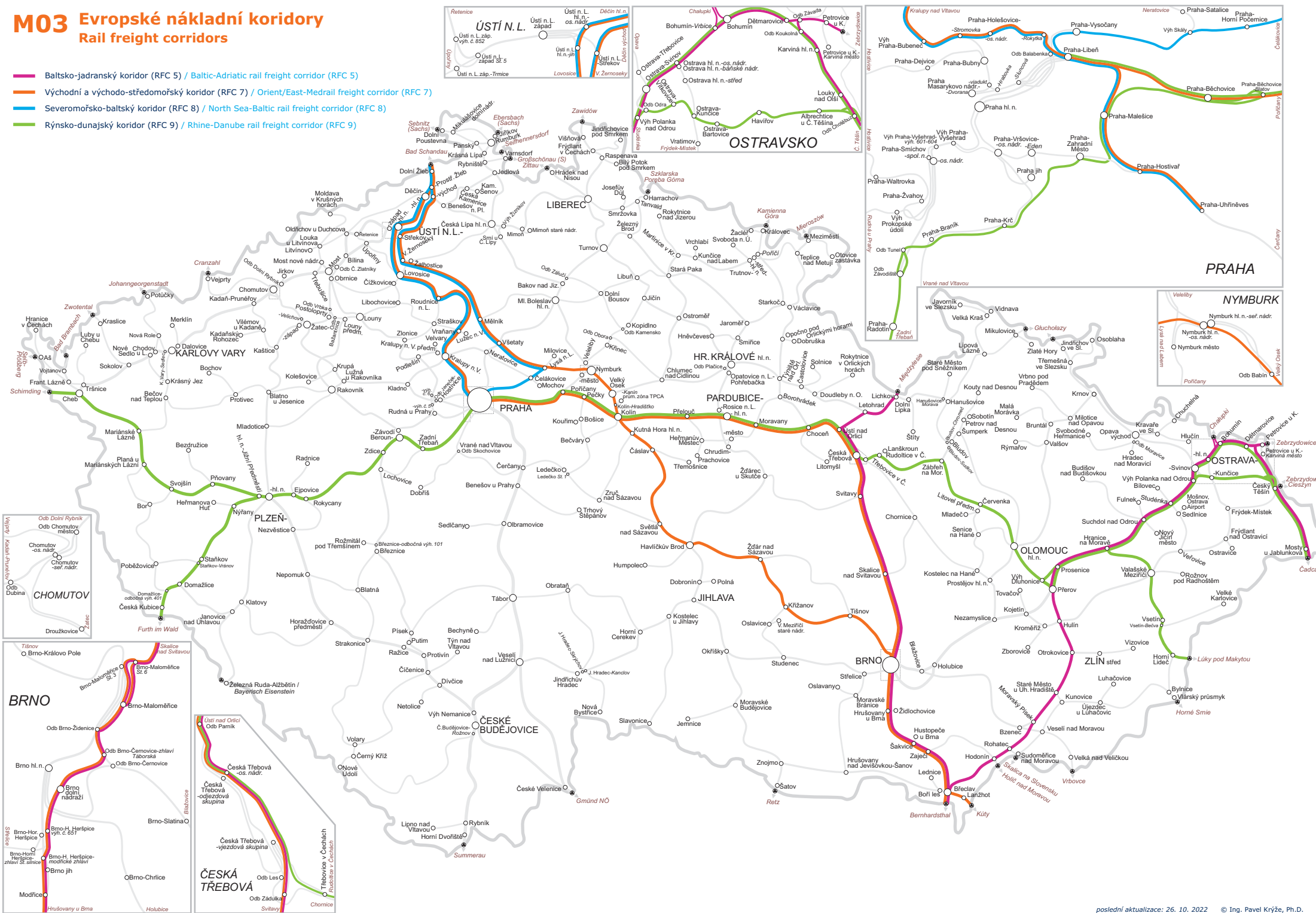

Rail freight corridors

- Baltsko-jadranský koridor (RFC 5) / Baltic-Adriatic rail freight corridor (RFC 5)
- Východní a východo-středomořský koridor (RFC 7) / Orient/East-Medrail freight corridor (RFC 7)
- Severomořsko-baltský koridor (RFC 8) / North Sea-Baltic rail freight corridor (RFC 8)
- Rýnsko-dunajský koridor (RFC 9) / Rhine-Danube rail freight corridor (RFC 9)





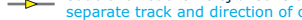

M05 Počty kolejí, systémy trakčních soustav a čísla podle knižního jízdního řádu

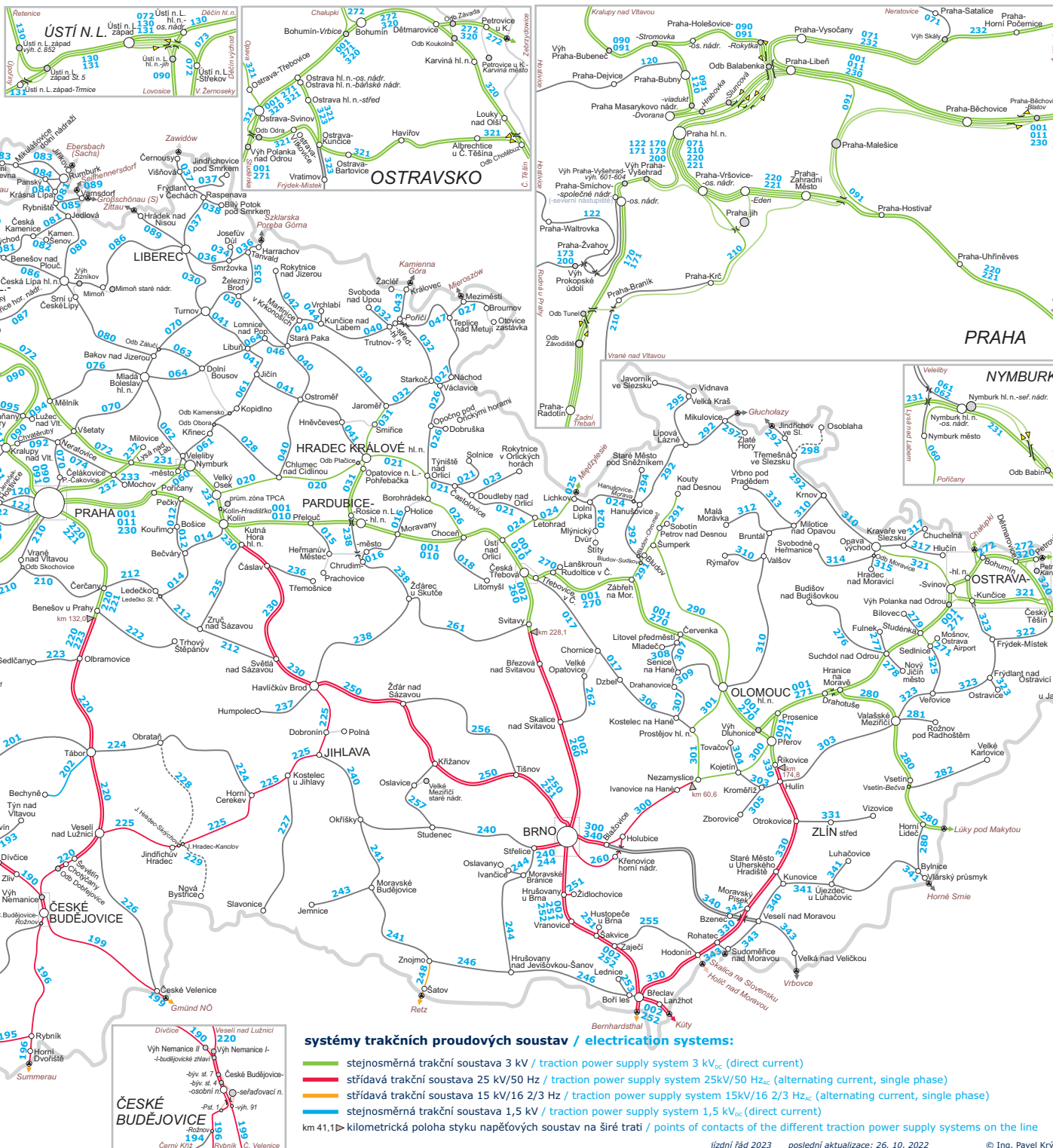
Number of tracks, electrification systems and numbers according to timetable

-  jednokolejná trať / single track line
-  dvoukolejná trať / double track line
-  trojkolejná trať / triple track line
-  odděleně vedená kolej dvoukolejná trať; obvyklý směr jízdy / separate track and direction of operation
-  úzkorozchodná trať / narrow gauge
-  místo není určeno pro nástup a výstup cestujících / place not intended for passengers
-  trať v knižním jízdním řádu neuvedená / line not mentioned in timetable
- 170** číslo podle knižního jízdního řádu / number according to timetable



systémy trakčních proudových soustav / electrification systems:

-  stejnosměrná trakční soustava 3 kV / traction power supply system 3 kV_{dc} (direct current)
-  střídavá trakční soustava 25 kV/50 Hz / traction power supply system 25kV/50 Hz_{ac} (alternating current, single phase)
-  střídavá trakční soustava 15 kV/16 2/3 Hz / traction power supply system 15kV/16 2/3 Hz_{ac} (alternating current, single phase)
-  stejnosměrná trakční soustava 1,5 kV / traction power supply system 1,5 kV_{dc} (direct current)

km 41,1 ► kilometrická poloha styku napěťových soustav na širé trati / points of contacts of the different traction power supply systems on the line

jízdní řád 2023 poslední aktualizace: 26. 10. 2022 © Ing. Pavel Krýže, Ph.D.

M06 Dálkové řízení provozu

Remote control of operation

- **Zdice** dopravná / trať je řízena z CDP Praha
station / line is controlled by CDP Praha
- **Hulín** dopravná / trať je řízena z CDP Pířerov
station / line is controlled by CDP Pířerov
- **Tanvald** dopravná / trať je řízena z RDP
station / line is controlled by RDP
- **Nejdek** dopravná / trať je řízena z jiného místa
station / line is controlled by other place
- Svitavy místo vykonávající dálkové ovládní
place performing the remote control
- hranice řízených oblastí
border of controlled areas

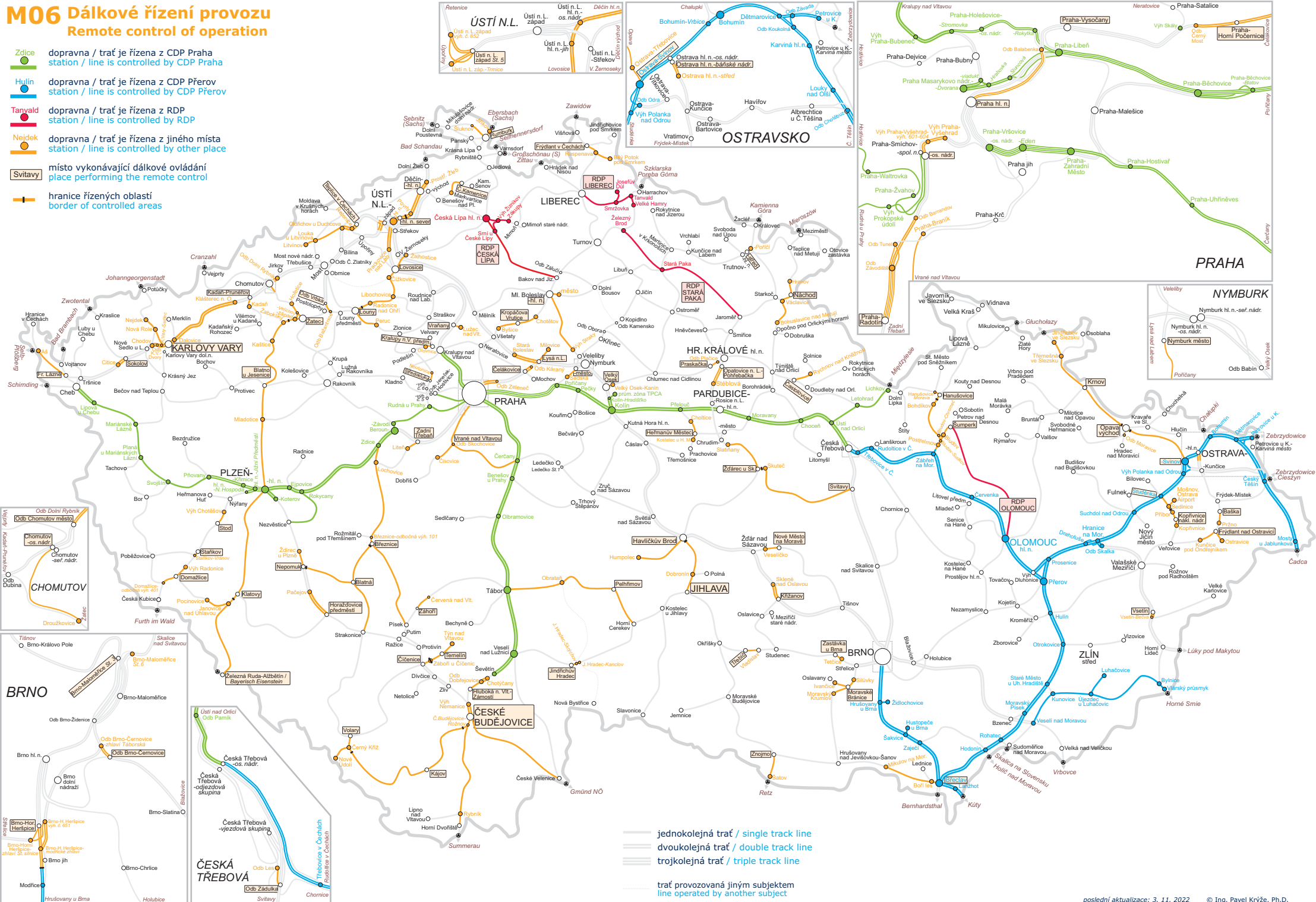

jednokolejná trať / single track line
 dvukolejná trať / double track line
 trojkolejná trať / triple track line
 trať provozovaná jiným subjektem
 line operated by another subject

M07 Dovolené traťové třídy zatížení

(zatížení na nápravu / na běžný metr)
 Allowed line classes of loading (axle load / load per meter)

- A1 (16 t / 5 t)
- B1 (18 t / 5 t)
- B2 (18 t / 6,4 t)
- C2 (20 t / 6,4 t)
- C3 (20 t / 7,2 t)
- C4 (20 t / 8 t)
- D2 (22,5 t / 6,4 t)
- D3 (22,5 t / 7,2 t)
- D4 (22,5 t / 8 t)

v závorkách jsou uvedeny přípustné hmotnosti na nápravu a na běžný metr
 axle load and weight spread over a length unit are in the round brackets

- úzkorozchodná trať bez přířazené traťové třídy
 narrow-gauge rail system without line class
- trať provozovaná jiným subjektem
 line operated by another subject

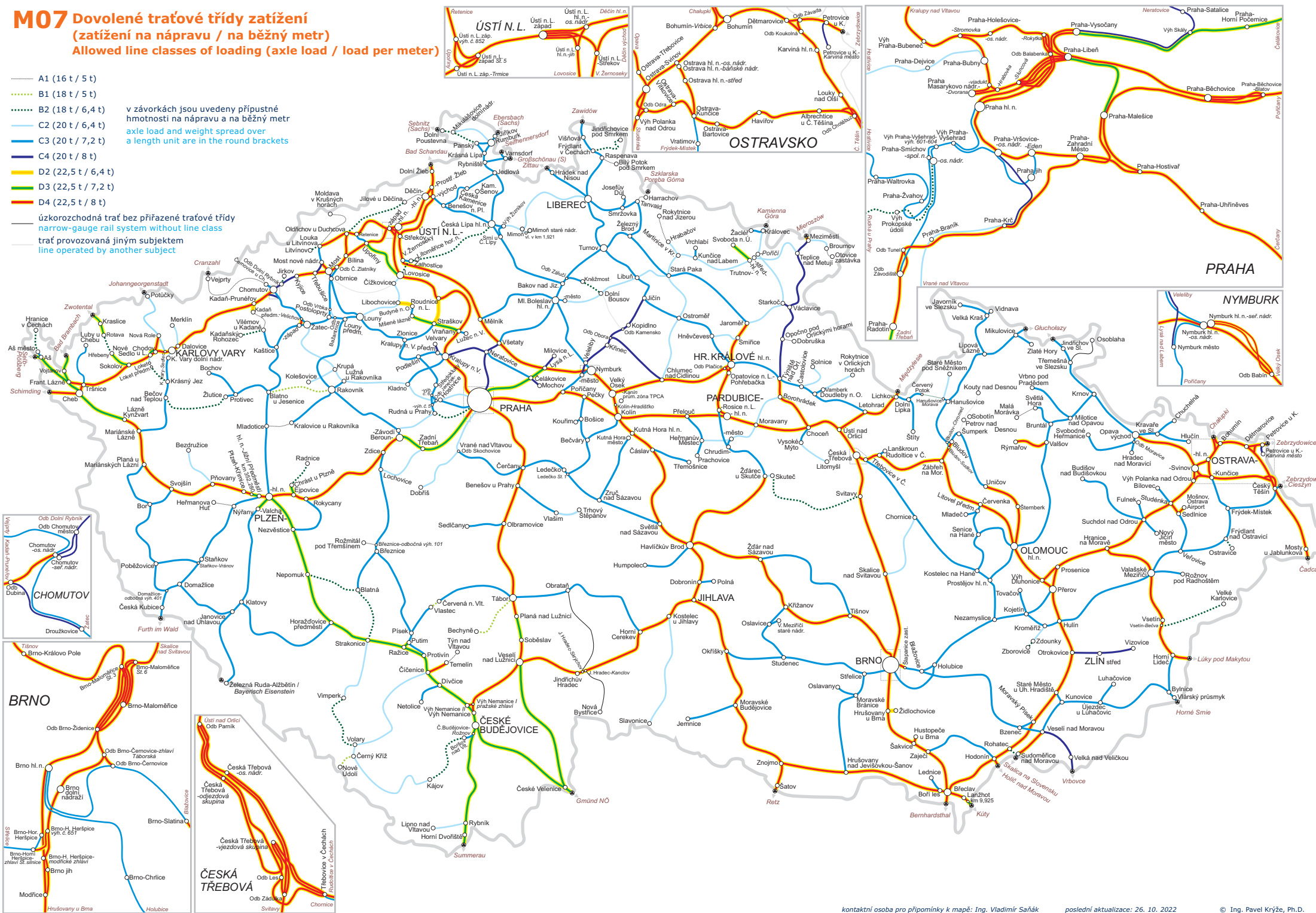

M08 Traťová zabezpečovací zařízení

Railway signalling systems

- tříznakový automatický blok obousměrný / bidirectional three-sign automatic block system
- automatické hradlo / automatic line block system
- automatické hradlo s oddílí ohraničenými značkami ETCS / automatic line block system with blocks bordered by ETCS marker
- úsek s oddílí ohraničenými oddílovými návěstími hlásky, hradla nebo aut. hradla / system with blocks bordered by conventional signals
- reléový poloautomatický blok s kontrolou volnosti tratě zařízením / relay semi-automatic block system with line free control by technical system
- reléový poloautomatický bez kontroly volnosti tratě zařízením / relay semi-automatic block system without line free control by technical system
- hradlový poloautomatický / semi-automatic line block
- telefonické dorozumívání / telephone communication
- telefonické dorozumívání, trať je ohraničena jen jednou dopravnou / telephone communication, line bounded with one operating post only
- provoz podle předpisu D3 / operation according to D3 regulation
- provoz podle předpisu D4 / operation according to D4 regulation

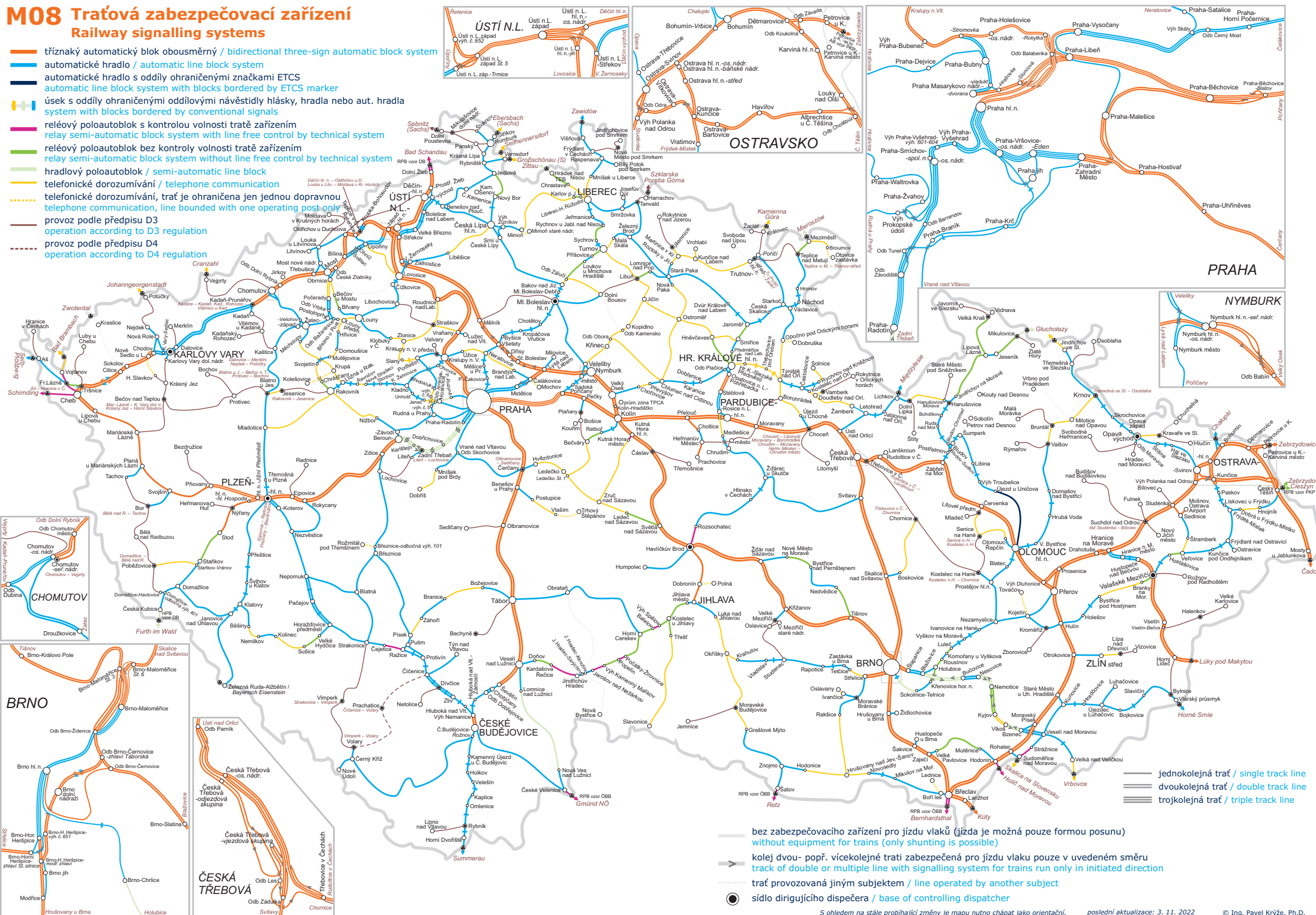

- jednokolejná trať / single track line
- = dvukolejná trať / double track line
- = trojkolejná trať / triple track line

- bez zabezpečovacího zařízení pro jízdu vlaků (jízda je možná pouze formou posunu) / without equipment for trains (only shunting is possible)
- koleje dvou- popř. víceokolejné trati zabezpečené pro jízdu vlaku pouze v uvedeném směru / track of double or multiple line with signalling system for trains run only in initiated direction
- trať provozovaná jiným subjektem / line operated by another subject
- sídlo dirigujiícího dispečera / base of controlling dispatcher

M09 Vlakový zabezpečovač (ATP) Cab signalling (ATP)

ETCS úroveň 2, stav předpokládán k 11. 12. 2022
ETCS level 2, condition supposed to 11. 12. 2022

- vlakový zabezpečovač LS
cab signalling LS
- vlakový zabezpečovač INDUSI/PZB
cab signalling INDUSI/PZB

⋯ trať provozovaná jiným subjektem
line operated by another subject

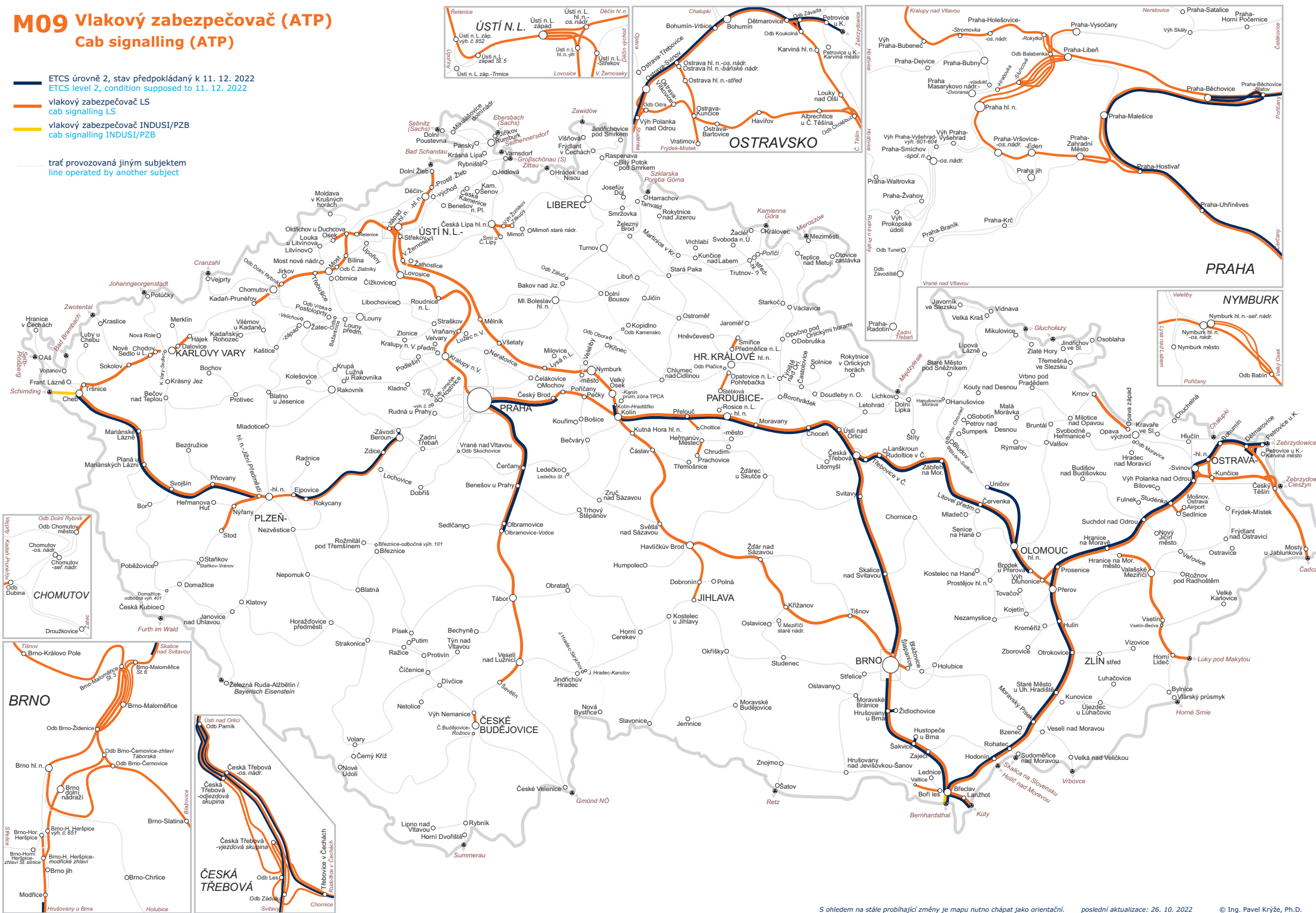

M10 Základní traťové rádiové spojení

Primary ground-to-train radio communication

GSM-R Traťový rádiový systém s vlastnostmi podle odst. 2.1 přílohy F platného Prohlášení o dráze (dále jen „PoD“) zajišťující kontinuální pokrytí tratě
Ground-to-train radio system according to the art. 2.1 of the Annex F of the valid Network Statement (hereinafter „PoD“ only) providing continuous coverage of the line

SRD Traťový rádiový systém s vlastnostmi podle odst. 2.2 přílohy F platného PoD zajišťující kontinuální pokrytí tratě
Ground-to-train radio system according to the art. 2.2 of the Annex F of the valid PoD providing continuous coverage of the line

SRV Simplexní rádiové spojení s vlastnostmi podle odst. 2.4 přílohy F platného PoD, zpravidla na tratích s řízením provozu podle předpisu SŽDC D3 pro hlasovou komunikaci dispečera/výpravčího se strojevodcem v dosahu základního radiostanice, spolehlivé pokrytí dopraven a přílehlých traťových úseků není zaručeno, podmínky používání jsou uvedeny v Provozním řádu
Simplex ground-to-train radio communication according to the art. 2.4 of the Annex F of the valid PoD, usually used on the lines with the traffic control according to the Rule SŽDC D3 for voice communication between dispatchers and engine drivers in the base station range, reliable coverage of operating posts and adjacent line sections is not guaranteed, conditions of usage are published in the Operational Order (Provozní řád)

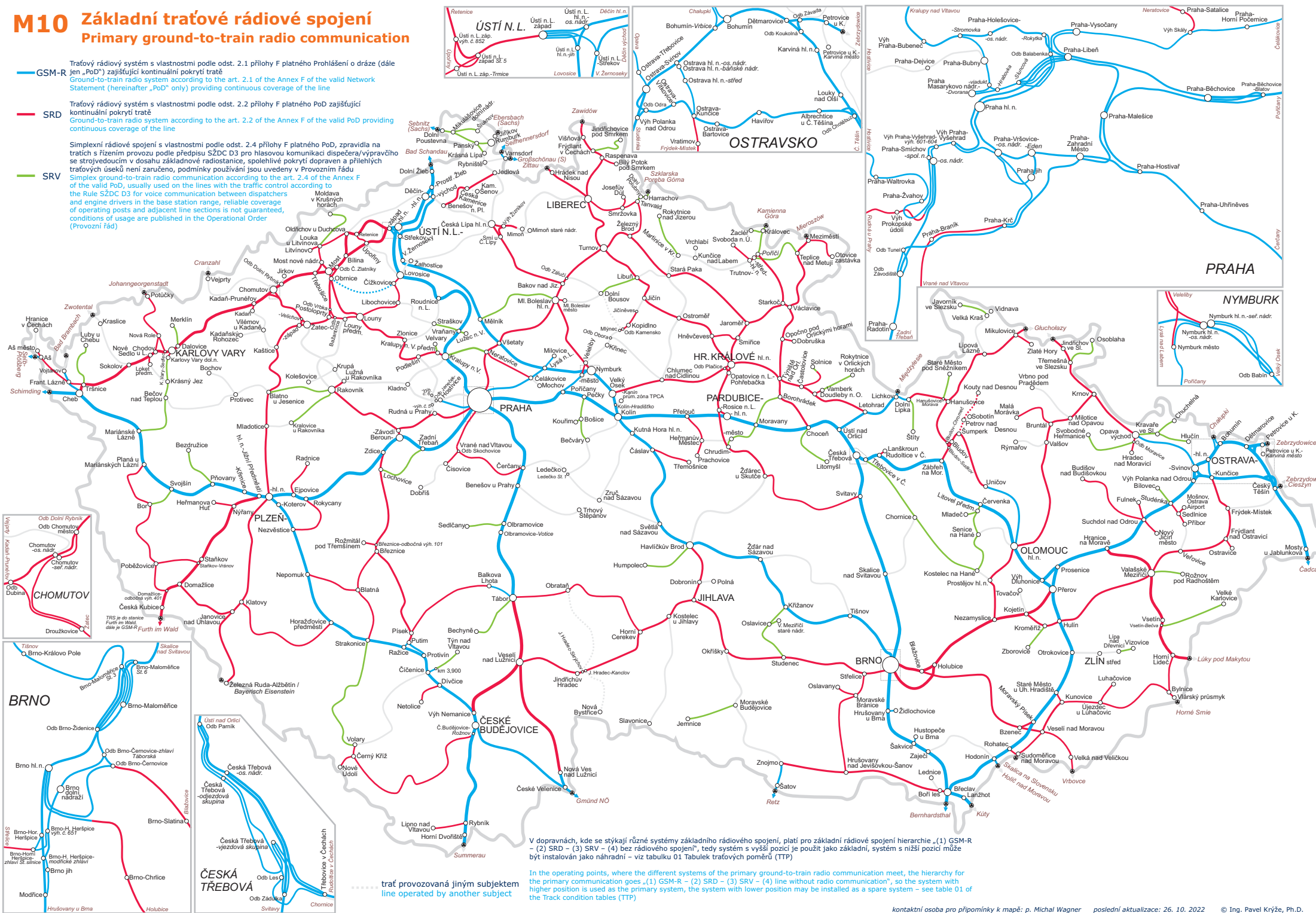

V dopravních, kde se stýkají různé systémy základního rádiového spojení, platí pro základní rádiové spojení hierarchie „(1) GSM-R – (2) SRD – (3) SRV – (4) bez rádiového spojení“, tedy systémy s vyšší pozicí je použit jako základní, systém s nižší pozicí může být instalován jako náhradní – viz tabulku 01 Tabulek traťových poměrů (TTP)

In the operating points, where the different systems of the primary ground-to-train radio communication meet, the hierarchy for the primary communication goes „(1) GSM-R – (2) SRD – (3) SRV – (4) line without radio communication“, so the system with higher position is used as the primary system, the system with lower position may be installed as a spare system – see table 01 of the Track condition tables (TTP)

--- trať provozovaná jiným subjektem
--- line operated by another subject

M11 Kódy tratí pro kombinovanou dopravu

Lines codes for combined traffic

- 45/358
- 57/381
- 72/391
- 80/410
- 47/360
- 67/391
- 78/402

Kód tratě kombinované dopravy označuje číslo maximálního profilu použitelného pro příslušnou trať. Kód ložné jednotky nesmí být vyšší než kódové číslo tratě.

Vlaky kombinované dopravy se směrnatným profilem mají stanovenou trasu po tratích, na nichž je kód vyhlášen, a nesmí být odkloněny na trať s nižším kódem, ani na trať bez vyhlášeného kódu. Kódy tratí stanovuje a vyhláší URMIZA.

Combined traffic track (line) code marks maximum profile number usable for relevant track (line). The load unit code must not exceed the track code number. Combined traffic trains with decisive profile have their path determined on the tracks (lines) where the code is declared, and they must not be diverted to lower code track (line), neither to track (line) without code declared. Tracks (lines) codes determine and declare URMIZA.

..... trať provozovaná jiným subjektem
line operated by another subject

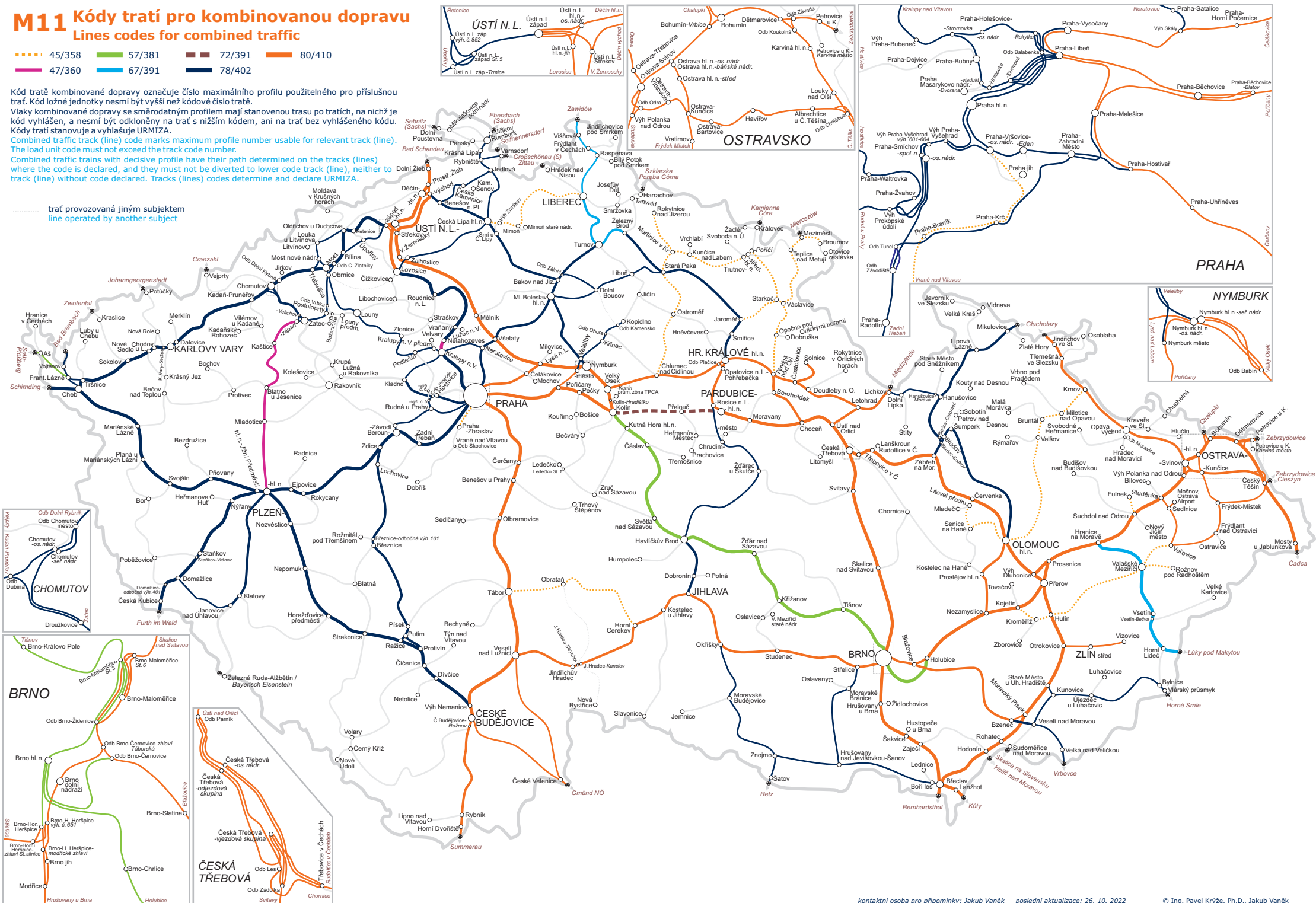

M12 Oblastní ředitelství (OŘ), stavební správy a provozní obvody

hranice obvodů OŘ je vyznačena z hlediska řízení provozu

Děčín provozní obvod; název je podtržen

vymezení hranice mezi OŘ

vymezení hranice provozních obvodů v rámci stejného OŘ

Vysvětlení zkratky:
 vj. n. – vjezdové návštěvídlo
 lich. tab. – lichoběžníková tabulka

..... trať provozovaná jiným subjektem

OŘ Ústí nad Labem

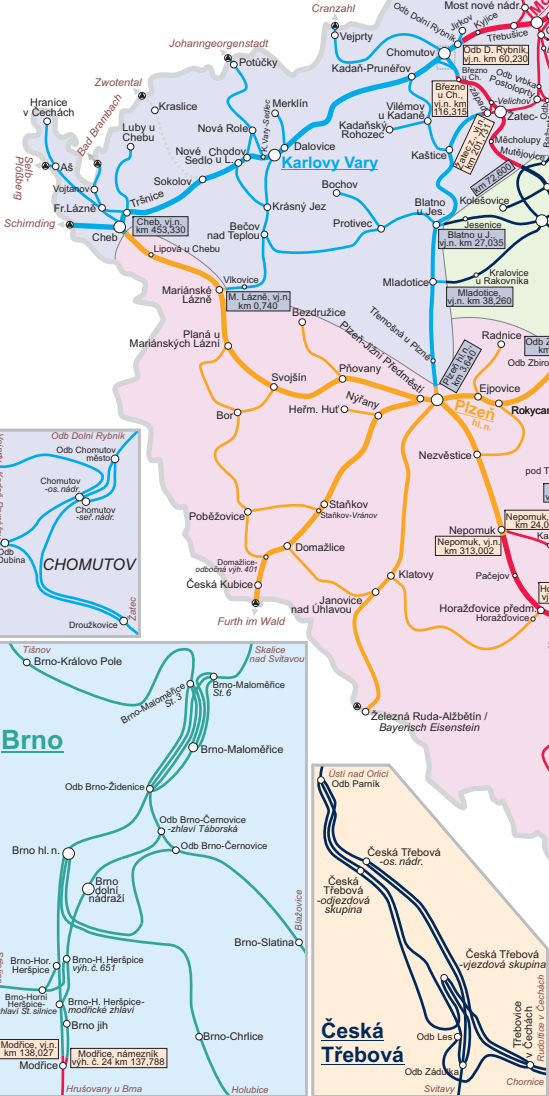

Brno

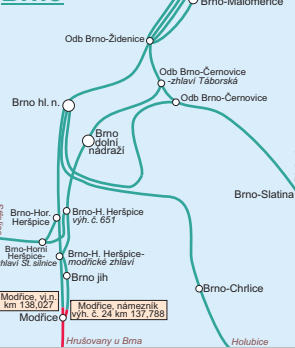

Česká Třebová



- 1 Louka u L., vj. n. km 11,301
- 2 Oldřichov u D., vj. n. km 39,298
- 3 Oldřichov u D., vj. n. km 23,790
- 4 Obornice, vj. n. km 35,717
- 5 Velké Žernosky, vj. n. km 0,465
- 6 Čelákovice, vj. n. km 20,058
- 7 Mstětice, vj. n. km 13,545
- 8 Praha-Čakovice, vj. n. km 20,058
- 9 Rostok u Prahy, vj. n. km 420,638
- 10 Praha-Ruzyně, vj. n. km 11,372
- 11 Praha-Zličín, vj. n. km 16,238

OŘ Praha

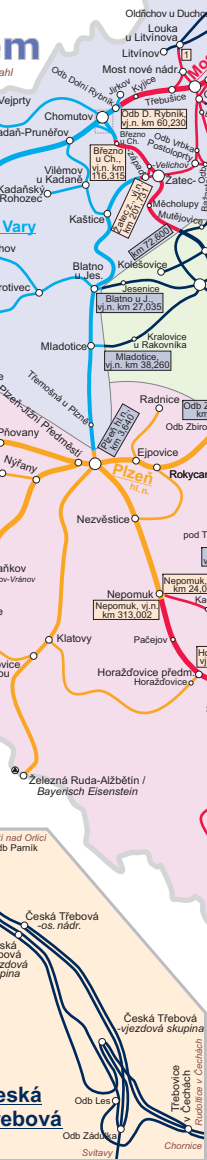

OŘ Plzeň



OŘ Liberec

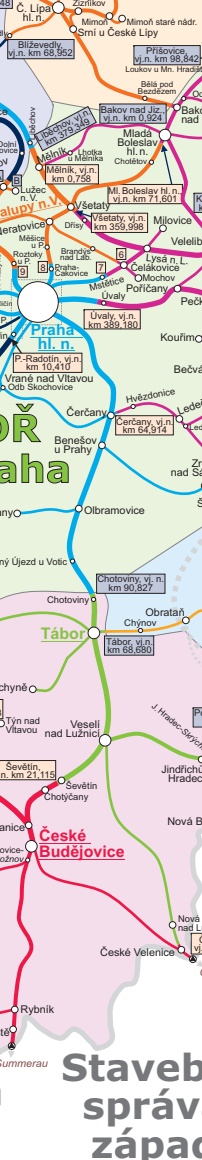

OŘ Hr. Králové



OŘ Ostrava

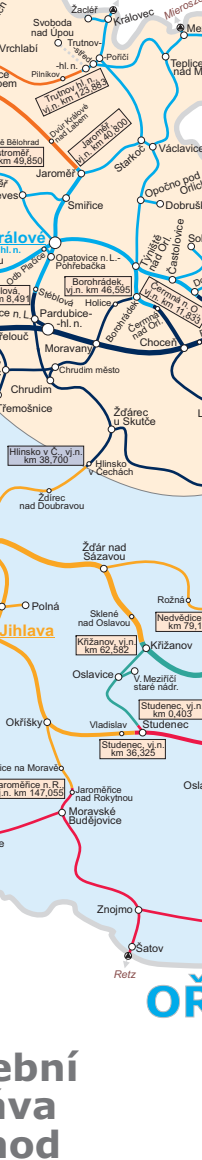

OŘ Brno



OŘ Olomouc

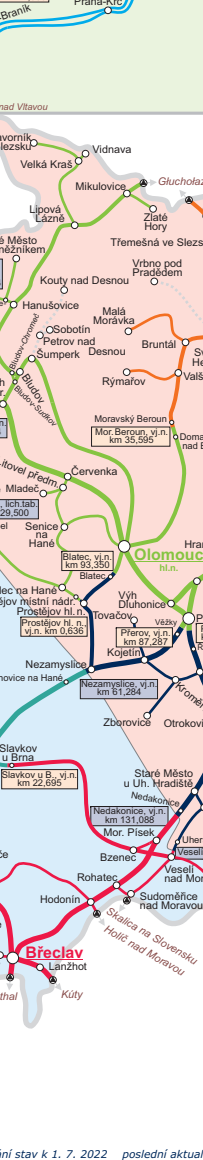

OŘ Valašské Meziříčí



OŘ Český Těšín

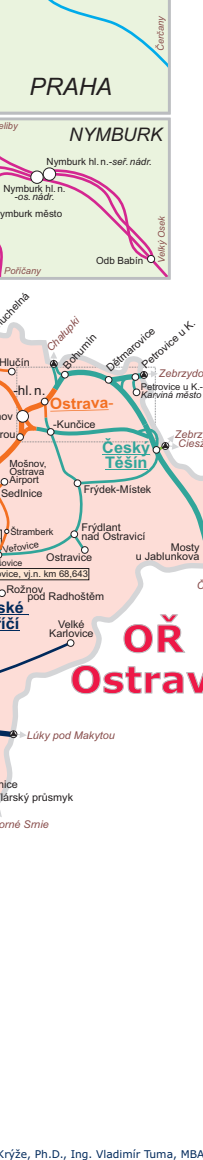

Stavební správa západ ← Stavební správa východ

M13 Informační body systému AVV (ATO)

Information points of system AVV (ATO)

trať vybavená informačními body systému AVV MIB-6
line with information points of system AVV MIB-6

trať vybavená informačními body systému AVV MIB-1 (GPS)
line with information points of system AVV MIB-1 (GPS)

trať provozovaná jiným subjektem
line operated by another subject

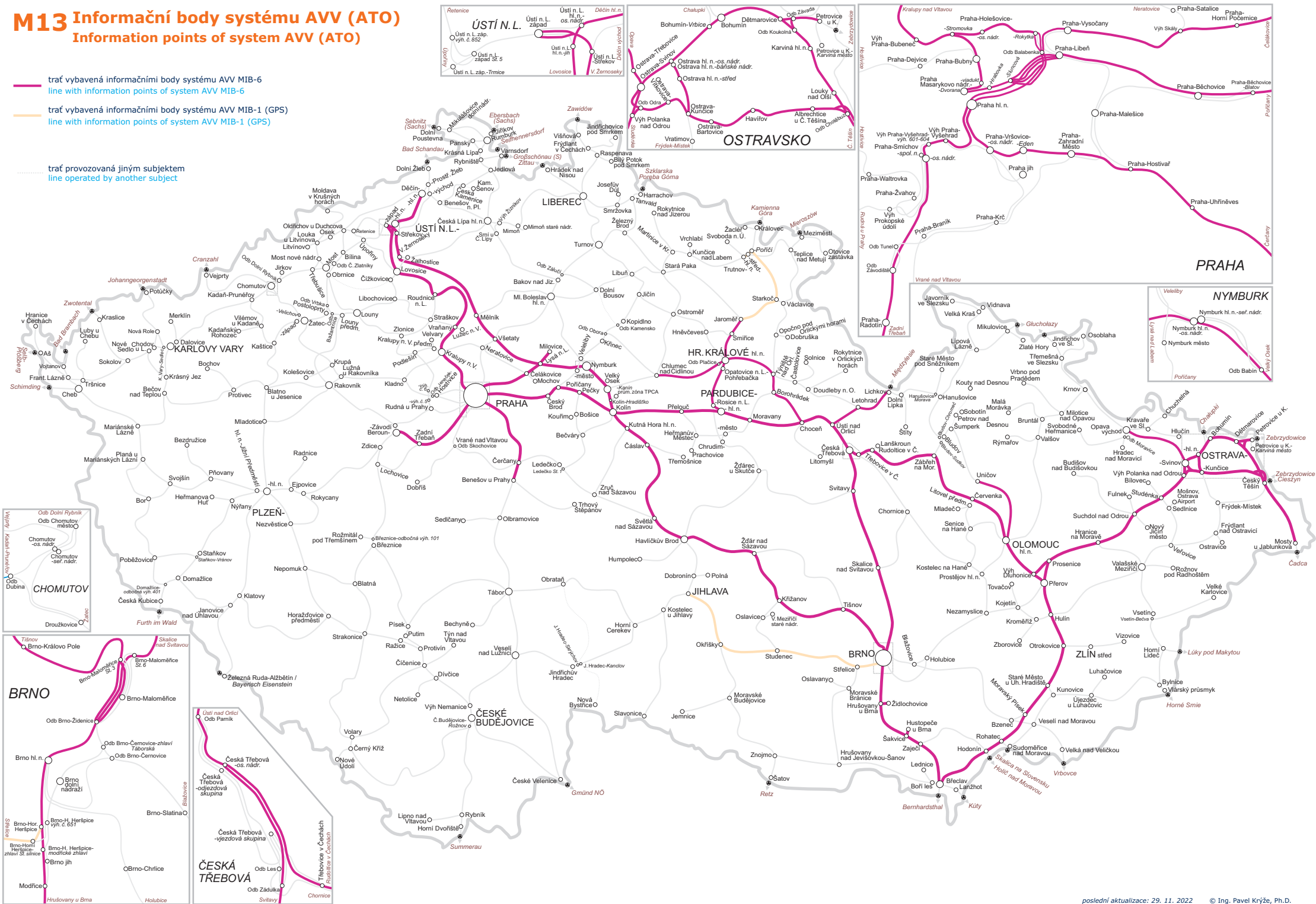

M14 Dráhy, kde Správa železnic uplatňuje sankci za odřeknutí kapacity a sankci za nevyužití kapacity

Lines where non usage charges and cancellation fees are applied

- trať, kde jsou sankce uplatňovány
line where charges and fees are applied
- trať, kde nejsou sankce uplatňovány
line where charges and fees are not applied
- - - trať ve vlastnictví jiného subjektu
line owned by another subject

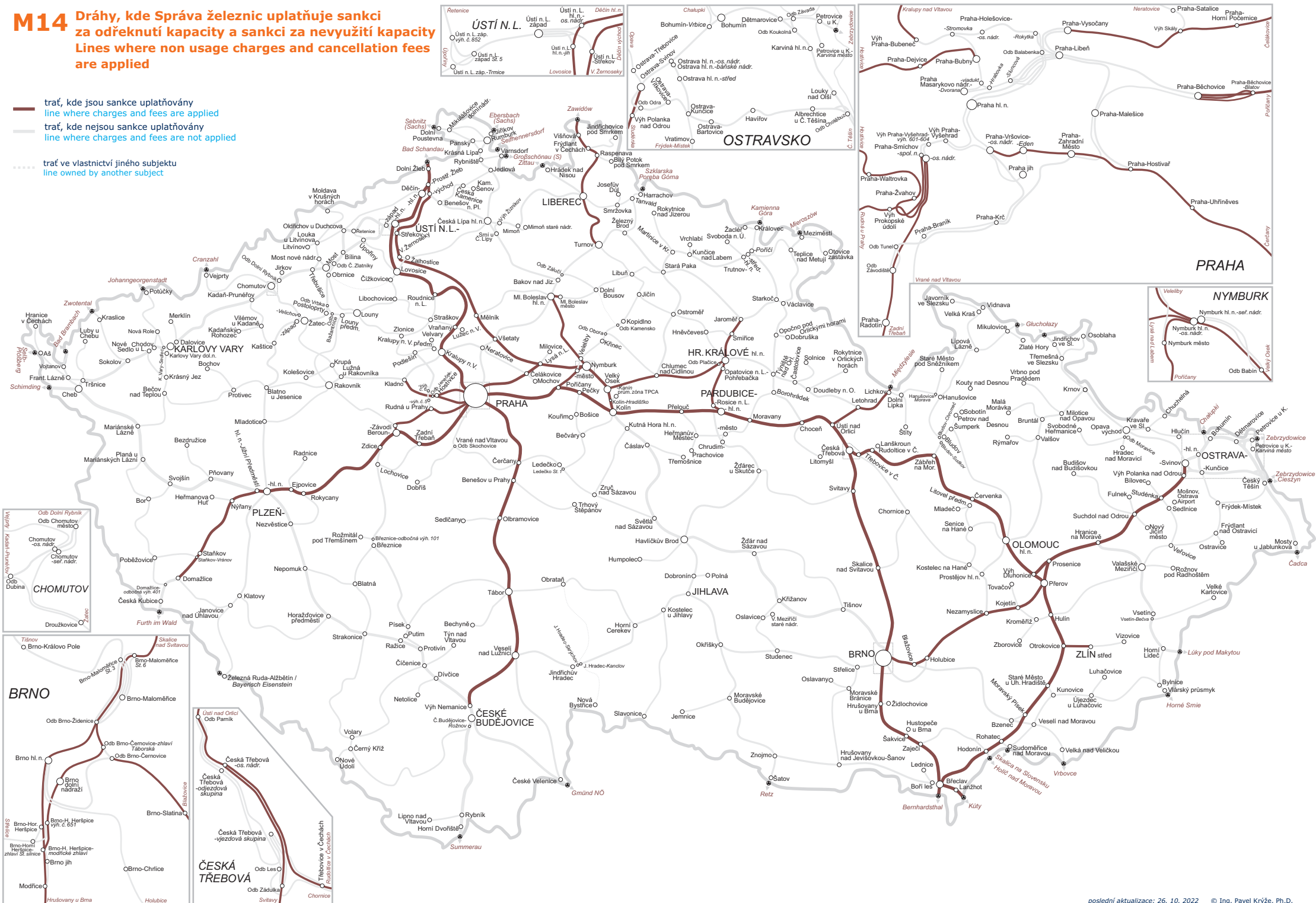

Správa železnic, státní organizace
Generální ředitelství
Dlážděná 1003/7
110 00 Praha 1

© 2023

Datum tisku
2023-03-03

www.spravazeleznic.cz